



<http://www.moda-ml.org>

IMPLEMENTATION GUIDE
TRANSACTION "KNITTING-CLOTHING COMMISSION ORDER"

Version: 2011-1

Date of release: 18/11/2011

Document code: G040

XML Schema repository:<http://www.moda-ml.org/moda-ml/repository/schema/v2011-1/default.asp>

Guides repository:<http://www.moda-ml.org/moda-ml/repository/guide/v2011-1/default.asp>

Guide filename: G040-MODA-ML-Knitting-clothingCommissionOrder.pdf

1. BUSINESS DESCRIPTION

1.1 Scope

to be defined

1.2 Generalities

The knitting-clothing commissio is used by the Knitwear or Clothing Company to commit to a Sub-contractor the manufacturing of knitwear or clothing articles

Each commission order can include one or more operations of the manufacturing cycle, each one correspondind to a line item

The document can be used either to order the manufacturing of finished goods or of component parts of them.

When the Commissioner orders a sequence of operations to different Sub-contractors, he can use this document also to dispose the delivering of semifinished goods from one Sub-contractor to the next.

This document specifies only the technology (when necessary) and the characteristics of the final product and of the initial goods (components) to be used in the manufacturing

The output product specified in each line item can be the inputcomponent in a following line item also in the same Commission order.

1.3. Possible scenario

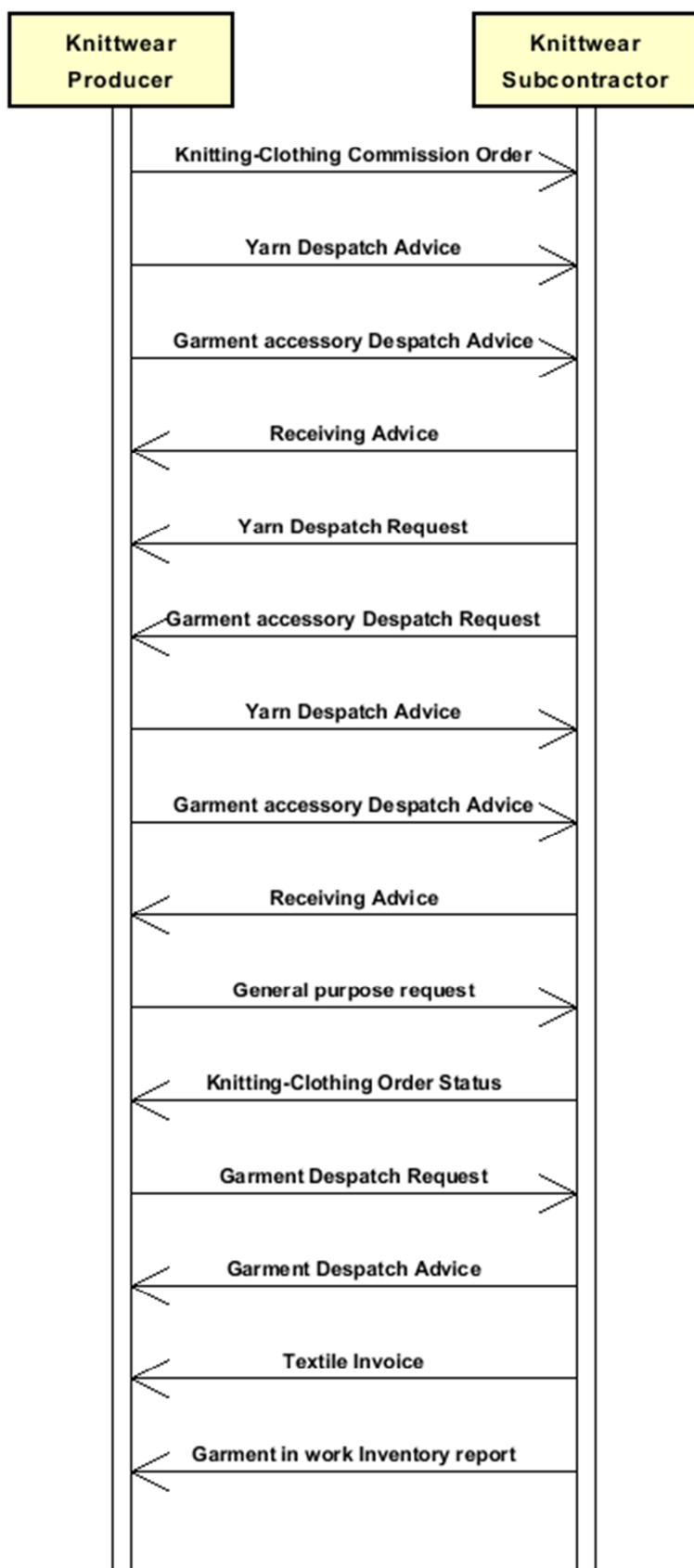

2. IMPLEMENTATION GUIDE

2.1 General structure of XML document

All the business data that can be exchanged through this class of documents are shown in the following "document structure", that provides a simplified vision of the Schema.

In particular:

- the two numbers following each element define its "cardinality" (minimum and maximum number of occurrences); the minimum equal zero indicates that the element is optional, the minimum greater than zero indicates that is mandatory;
- the bold character denotes the complex elements (aggregates of simple elements) that were built for the sake of functionality and re-usability of some complex informations sets. The child elements in each parent element are easily spotted as "indented";
- the symbol "@" denotes an attribute of the preceding element; here "the usage indicator (optional, required, ...) is shown in square brackets.

Structure

KnitClothOrder

@msgfunction [Optional] [Default= OR]

KCCOheader 1-1

msgN 1-1

- choose -

msgID 0-1

- or -

docID 0-1

@numberingOrg [Optional]

- end choose -

msgDate 1-1

@dateForm [Optional]

season 0-1

msgCurrency 0-1

refDoc 0-9

@docType [Required]

docID 1-2

@numberingOrg [Optional]

docDate 0-1

@dateForm [Optional]

season 0-1

itemID 0-1

buyer 1-1

@logo [Optional]

@sender [Optional]

id 1-1

@numberingOrg [Optional]

legalName 0-1

dept 0-1

person 0-1

@email [Optional]

@phone [Optional]

@fax [Optional]

street 0-1

city 0-1

subCountry 0-1

country 0-1

postCode 0-1

subContractor 1-1

@sender [Optional]

id 1-1

@numberingOrg [Optional]
legalName 0-1
dept 0-1
person 0-1
@email [Optional]
@phone [Optional]
@fax [Optional]
street 0-1
city 0-1
subCountry 0-1
country 0-1
postCode 0-1

thirdParty 0-1

@VAT [Optional]
@role [Required]
@sender [Optional]
id 1-1
@numberingOrg [Optional]
legalName 0-1
dept 0-1
person 0-1
@email [Optional]
@phone [Optional]
@fax [Optional]
street 0-1
city 0-1
subCountry 0-1
country 0-1
postCode 0-1

note 0-1

@numberingOrg [Optional]
@codeList [Optional]
@noteLabel [Optional]

terms 0-1

payment 0-5

@finDiscount [Optional]
@finSurcharge [Optional]
- choose -
 payTerm 1-1
- or -
 payTermText 1-1
- end choose -
 payMode 0-1

insPayment 0-5

@part [Required]
- choose -
 payTerm 1-1
- or -
 payTermText 1-1
- end choose -
 payMode 0-1

trade 0-1

- choose -
 incoTermText 1-1
- or -
 incoTerm 1-1
- end choose -
 location 0-1
 @LRI [Optional]

transInfo 0-1

@transReason [Optional]
transMode 1-1
carrier 0-1
deliveryPlace 0-1
grossWeight 0-1
@um [Required]
netWeight 0-1
@um [Required]
transMeans 0-1
transCondition 0-3
transConditionText 0-1

allowanceCharge 0-9

@VAT [Optional]
- choose -
AC_category 1-1
- or -
AC_categoryText 1-1
- choose -
AC_percent 1-1
- or -
AC_amount 1-1
- end choose -

KCCObody 1-1

KCCOitem 1-unbounded

@productLevel [Optional] [Default= END]
lineN 1-1
@VAT [Optional]
apparelProd 1-1
- choose -
garmentPartCode 1-1
@numberingOrg [Optional]
gPart 1-1
mod 1-1
@numberingOrg [Optional]
@codeList [Optional]
@listName [Optional]
@listVersion [Optional]
fabric 0-1
@numberingOrg [Optional]
@codeList [Optional]
@listName [Optional]
@listVersion [Optional]
color 0-1
@numberingOrg [Optional]
@codeList [Optional]
@listName [Optional]
@listVersion [Optional]
size 0-1
@codeList [Optional]
description 0-1
- or -
garmentCode 1-2
@numberingOrg [Optional]
- choose -
garmentCodeB 1-1
@numberingOrg [Optional]
mod 1-1
@numberingOrg [Optional]
@codeList [Optional]
@listName [Optional]

@listVersion [Optional]
 fabric 0-1
 @numberingOrg [Optional]
 @codeList [Optional]
 @listName [Optional]
 @listVersion [Optional]
 color 0-1
 @numberingOrg [Optional]
 @codeList [Optional]
 @listName [Optional]
 @listVersion [Optional]
 size 0-1
 @codeList [Optional]
 artGroup 0-1
 @numberingOrg [Optional]
 @codeList [Optional]
 @listName [Optional]
 @listVersion [Optional]
 added 0-9
 @addType [Optional]
 description 0-1
 - or -
garmentCodeA 1-1
 art 1-1
 @numberingOrg [Optional]
 @codeList [Optional]
 @listName [Optional]
 @listVersion [Optional]
 description 0-1
 - end choose -
 - end choose -
 lotN 0-1
 @numberingOrg [Optional]
 dyeN 0-1
 @numberingOrg [Optional]
 qty 1-2
 @um [Required]
csRange 0-99
 @numberingOrg [Optional]
 @sizeSystemNat [Optional]
 @sizeSystemSeg [Optional]
 @sizeSystemBase [Optional]
 color 0-1
 @numberingOrg [Optional]
 @codeList [Optional]
 @listName [Optional]
 @listVersion [Optional]
sizeMatrix 1-1
sizeRow 1-99
 drop 0-1
 @codeList [Optional]
 size 1-1
 @codeList [Optional]
 qty 0-1
 @um [Required]
 note 0-1
 @numberingOrg [Optional]
 @codeList [Optional]
 @noteLabel [Optional]
 price 0-1
 @um [Optional]

@priceQualifier [Optional] [Default= NET]
 deliveryDate 0-1
 @dateForm [Optional]
thirdParty 0-5
 @VAT [Optional]
 @role [Required]
 @sender [Optional]
 id 1-1
 @numberingOrg [Optional]
 legalName 0-1
 dept 0-1
 person 0-1
 @email [Optional]
 @phone [Optional]
 @fax [Optional]
 street 0-1
 city 0-1
 subCountry 0-1
 country 0-1
 postCode 0-1
garTecSheet 0-1
 garmentCode 1-2
 @numberingOrg [Optional]
 - choose -
 garmentCodeB 1-1
 @numberingOrg [Optional]
 mod 1-1
 @numberingOrg [Optional]
 @codeList [Optional]
 @listName [Optional]
 @listVersion [Optional]
 fabric 0-1
 @numberingOrg [Optional]
 @codeList [Optional]
 @listName [Optional]
 @listVersion [Optional]
 color 0-1
 @numberingOrg [Optional]
 @codeList [Optional]
 @listName [Optional]
 @listVersion [Optional]
 size 0-1
 @codeList [Optional]
 artGroup 0-1
 @numberingOrg [Optional]
 @codeList [Optional]
 @listName [Optional]
 @listVersion [Optional]
 added 0-9
 @addType [Optional]
 description 0-1
 - or -
 garmentCodeA 1-1
 art 1-1
 @numberingOrg [Optional]
 @codeList [Optional]
 @listName [Optional]
 @listVersion [Optional]
 description 0-1
 - end choose -
refDoc 0-9

@docType [Required]
 docID 1-2
 @numberingOrg [Optional]
 docDate 0-1
 @dateForm [Optional]
 season 0-1
 itemID 0-1
fabricCompos 0-1
 percCompos 1-9
 @fibre [Required]
 customsStat 0-1
 grossWeight 0-1
 @um [Required]
 netWeight 0-1
 @um [Required]
garSizeSet 0-1
 @numberingOrg [Optional]
garSizeTier 1-9
 garSizeCode 1-1
 sizeStart 1-1
 sizeEnd 0-1
garMeaSet 0-99
 garAttrib 1-1
garMea 1-9
 size 1-1
 @codeList [Optional]
 specValue 1-1
 @um [Optional]
 @method [Optional]
garConsumptionSet 0-99
 - choose -
acsCode 1-1
 @numberingOrg [Optional]
 art 1-1
 @numberingOrg [Optional]
 @codeList [Optional]
 @listName [Optional]
 @listVersion [Optional]
 pattern 0-1
 @numberingOrg [Optional]
 @codeList [Optional]
 @listName [Optional]
 @listVersion [Optional]
 color 0-1
 @numberingOrg [Optional]
 @codeList [Optional]
 @listName [Optional]
 @listVersion [Optional]
 added 0-9
 @addType [Optional]
 description 0-1
 - or -
texCode 1-1
 @numberingOrg [Optional]
 art 1-1
 @numberingOrg [Optional]
 @codeList [Optional]
 @listName [Optional]
 @listVersion [Optional]
 pattern 0-1
 @numberingOrg [Optional]

@codeList [Optional]
 @listName [Optional]
 @listVersion [Optional]
 color 0-1
 @numberingOrg [Optional]
 @codeList [Optional]
 @listName [Optional]
 @listVersion [Optional]
 added 0-9
 @addType [Optional]
 description 0-1
 - or -
yarnCode 1-1
 @numberingOrg [Optional] [Default= CL]
 art 1-1
 @numberingOrg [Optional]
 @codeList [Optional]
 @listName [Optional]
 @listVersion [Optional]
 color 0-1
 @numberingOrg [Optional]
 @codeList [Optional]
 @listName [Optional]
 @listVersion [Optional]
 added 0-9
 @addType [Optional]
 description 0-1
 - end choose -
garConsumption 1-9
 @numberingOrg [Optional]
 garSizeCode 0-1
 qty 1-1
 @um [Required]
 qtyVariance 0-1
 @um [Optional]
 @varReason [Optional]
 mnfrNote 0-99
 @subject [Optional]
 image 0-99
 @subject [Optional]
progress 0-9
 qty 1-2
 @um [Required]
 deliveryDate 0-1
 @dateForm [Optional]
 delGrantedDate 0-1
 @dateForm [Optional]
 - choose -
 mfrStatus 0-1
 - or -
 mfrStatusText 0-1
 - end choose -
apparelComponent 0-9
 gPart 0-1
yarnComponent 0-9
 @CQQ [Optional]
 pcQty 0-1
 @um [Optional]
yarnCode 1-1
 @numberingOrg [Optional] [Default= CL]
 art 1-1

@numberingOrg [Optional]
 @codeList [Optional]
 @listName [Optional]
 @listVersion [Optional]
 color 0-1
 @numberingOrg [Optional]
 @codeList [Optional]
 @listName [Optional]
 @listVersion [Optional]
 added 0-9
 @addType [Optional]
 description 0-1
 lotN 0-1
 @numberingOrg [Optional]
 dyeN 0-1
 @numberingOrg [Optional]
 qty 1-2
 @um [Required]
refDoc 0-1
 @docType [Required]
 docID 1-2
 @numberingOrg [Optional]
 docDate 0-1
 @dateForm [Optional]
 season 0-1
 itemID 0-1
 location 0-1
 @LRI [Optional]
 warpLetter 0-1
 weftLetter 0-1
 note 0-1
 @numberingOrg [Optional]
 @codeList [Optional]
 @noteLabel [Optional]
fabricComponent 0-9
texCode 1-1
 @numberingOrg [Optional]
 art 1-1
 @numberingOrg [Optional]
 @codeList [Optional]
 @listName [Optional]
 @listVersion [Optional]
 pattern 0-1
 @numberingOrg [Optional]
 @codeList [Optional]
 @listName [Optional]
 @listVersion [Optional]
 color 0-1
 @numberingOrg [Optional]
 @codeList [Optional]
 @listName [Optional]
 @listVersion [Optional]
 added 0-9
 @addType [Optional]
 description 0-1
 qty 1-3
 @um [Required]
 serialN 0-99
 @numberingOrg [Optional]
refDoc 0-1
 @docType [Required]

docID 1-2
 @numberingOrg [Optional]
 docDate 0-1
 @dateForm [Optional]
 season 0-1
 itemID 0-1
 location 0-1
 @LRI [Optional]
 note 0-1
 @numberingOrg [Optional]
 @codeList [Optional]
 @noteLabel [Optional]

garmentPartComponent 0-9

garmentPartCode 1-1

 @numberingOrg [Optional]
 gPart 1-1
 mod 1-1
 @numberingOrg [Optional]
 @codeList [Optional]
 @listName [Optional]
 @listVersion [Optional]
 fabric 0-1
 @numberingOrg [Optional]
 @codeList [Optional]
 @listName [Optional]
 @listVersion [Optional]
 color 0-1
 @numberingOrg [Optional]
 @codeList [Optional]
 @listName [Optional]
 @listVersion [Optional]
 size 0-1
 @codeList [Optional]
 description 0-1

lotN 0-1
 @numberingOrg [Optional]
 dyeN 0-1
 @numberingOrg [Optional]

qty 1-2
 @um [Required]

refDoc 0-1

 @docType [Required]
 docID 1-2
 @numberingOrg [Optional]
 docDate 0-1
 @dateForm [Optional]
 season 0-1
 itemID 0-1
 location 0-1
 @LRI [Optional]
 note 0-1
 @numberingOrg [Optional]
 @codeList [Optional]
 @noteLabel [Optional]

acsComponent 0-99

acsCode 1-1

 @numberingOrg [Optional]
 art 1-1
 @numberingOrg [Optional]
 @codeList [Optional]
 @listName [Optional]

@listVersion [Optional]
 pattern 0-1
 @numberingOrg [Optional]
 @codeList [Optional]
 @listName [Optional]
 @listVersion [Optional]
 color 0-1
 @numberingOrg [Optional]
 @codeList [Optional]
 @listName [Optional]
 @listVersion [Optional]
 added 0-9
 @addType [Optional]
 description 0-1
 lotN 0-1
 @numberingOrg [Optional]
 dyeN 0-1
 @numberingOrg [Optional]
 qty 1-2
 @um [Required]
refDoc 0-1
 @docType [Required]
 docID 1-2
 @numberingOrg [Optional]
 docDate 0-1
 @dateForm [Optional]
 season 0-1
 itemID 0-1
 location 0-1
 @LRI [Optional]
 note 0-1
 @numberingOrg [Optional]
 @codeList [Optional]
 @noteLabel [Optional]

appMnfrOperation 0-9

- choose -
- jobName 1-1
- or -
- appJob 1-1
- end choose -
- appJobTech 0-1

refDoc 0-1

- @docType [Required]
- docID 1-2
- @numberingOrg [Optional]
- docDate 0-1
- @dateForm [Optional]
- season 0-1
- itemID 0-1

appMachine 0-1

note 0-1

- @numberingOrg [Optional]
- @codeList [Optional]
- @noteLabel [Optional]

2.2 Detailed description of document elements

Following tables show all elements (complex and simple) used in this document. Description includes: 1) element's information: xml tag, name, brief description, data type and syntax constraints; 2) information about use of the element in a particular position in the document: xpath and possible associated notes.

2.2.1 Complex elements (Aggregate Business Information Entities)

Complex elements are those elements whose content is composed of other elements (childs).Complex elements are alphabetically ordered.

acsCode	full codification identifying an accessory product usually coupled with garment (XPath: KnitClothOrder/KCCObody/KCCOitem/apparelComponent/acsComponent/acsCode) 1-1 (XPath: KnitClothOrder/KCCObody/KCCOitem/garTecSheet/garConsumptionSet/acsCode) 1-1
acsComponent	identification details of a garment accessory used in a sub-contracted manufacturing operation (XPath: KnitClothOrder/KCCObody/KCCOitem/apparelComponent/acsComponent) 0-99
allowanceCharge	Allowances and Charges related to an Order or a contract (XPath: KnitClothOrder/terms/allowanceCharge) 0-9
apparelComponent	identification details of a component used in the sub-contracted production of an apparel article or of one of its part (knitwear/clothing) (XPath: KnitClothOrder/KCCObody/KCCOitem/apparelComponent) 0-9
apparelProd	manufacturing specifications for a knitwear/clothing article to be obtained from an operation of sub-contracted production (XPath: KnitClothOrder/KCCObody/KCCOitem/apparelProd) 1-1
appMnfrOperation	details of a manufacturing operation used for knitting/clothing (XPath: KnitClothOrder/KCCObody/KCCOitem/appMnfrOperation) 0-9
buyer	details of the Buyer - base type: , (XPath: KnitClothOrder/KCCOheader/buyer) 1-1
csRange	range of color-size for a garment article (knitwear/clothing) (XPath: KnitClothOrder/KCCObody/KCCOitem/apparelProd/csRange) 0-99
fabricComponent	identification details of a fabric used in a sub-contracted manufacturing operation (XPath: KnitClothOrder/KCCObody/KCCOitem/apparelComponent/fabricComponent) 0-9
fabricCompos	composition of the fabric according to the Directory 97/37/CE (XPath: KnitClothOrder/KCCObody/KCCOitem/garTecSheet/fabricCompos) 0-1
garConsumption	consumption of the component for the given size range (XPath: KnitClothOrder/KCCObody/KCCOitem/garTecSheet/garConsumptionSet/garConsumption) 1-9
garConsumptionSet	components and average prescribed or effective consumptions for a garment (XPath: KnitClothOrder/KCCObody/KCCOitem/garTecSheet/garConsumptionSet) 0-99
garMea	attribute's measure for the given size (XPath: KnitClothOrder/KCCObody/KCCOitem/garTecSheet/garMeaSet/garMea) 1-9

garMeaSet	physical measures of the set of sizes of a garment (XPath: KnitClothOrder/KCCObody/KCCOitem/garTecSheet/garMeaSet) 0-99
garmentCode	codification of the garment product (knitwear/clothing) (XPath: KnitClothOrder/KCCObody/KCCOitem/garTecSheet/garmentCode) 1-2 (XPath: KnitClothOrder/KCCObody/KCCOitem/apparelProd/garmentCode) 1-2
garmentCodeA	codification of the garment product (knitwear/clothing) - type A (XPath: KnitClothOrder/KCCObody/KCCOitem/apparelProd/garmentCode/garmentCodeA) 1-1 - note: <i>here the barcode EAN-13 or EAN-8 should be specified</i> (XPath: KnitClothOrder/KCCObody/KCCOitem/garTecSheet/garmentCode/garmentCodeA) 1-1 - note: <i>here the barcode EAN-13 or EAN-8 should be specified</i>
garmentCodeB	codification of the garment product (knitwear/clothing) - type B (XPath: KnitClothOrder/KCCObody/KCCOitem/apparelProd/garmentCode/garmentCodeB) 1-1 (XPath: KnitClothOrder/KCCObody/KCCOitem/garTecSheet/garmentCode/garmentCodeB) 1-1
garmentPartCode	codification of the component or part of a garment article (knitwear or clothing) (XPath: KnitClothOrder/KCCObody/KCCOitem/apparelProd/garmentPartCode) 1-1 (XPath: KnitClothOrder/KCCObody/KCCOitem/apparelComponent/garmentPartComponent/garmentPartCode) 1-1
garmentPartComponent	identification details of a garment part used in a sub-contracted manufacturing operation (XPath: KnitClothOrder/KCCObody/KCCOitem/apparelComponent/garmentPartComponent) 0-9
garSizeSet	size table for a garment (XPath: KnitClothOrder/KCCObody/KCCOitem/garTecSheet/garSizeSet) 0-1
garSizeTier	definition of the range of sizes associated with a given code (XPath: KnitClothOrder/KCCObody/KCCOitem/garTecSheet/garSizeSet/garSizeTier) 1-9
garTecSheet	garment technical sheet (XPath: KnitClothOrder/KCCObody/KCCOitem/garTecSheet) 0-1
insPayment	payment details for payment by installments (XPath: KnitClothOrder/terms/insPayment) 0-5 - note: <i>this set of data is alternative to payment set and must be iterated for each payment installment</i>
KCCObody	body of the document KNITTING/CLOTHING COMMISSION ORDER (XPath: KnitClothOrder/KCCObody) 1-1
KCCOheader	header of the document KNITTING/CLOTHING COMMISSION ORDER (XPath: KnitClothOrder/KCCOheader) 1-1
KCCOitem	line of the document KNITTING/CLOTHING COMMISSION ORDER (XPath: KnitClothOrder/KCCObody/KCCOitem) 1-unbounded
payment	payment details for payment all in one (XPath: KnitClothOrder/terms/payment) 0-5 - note: <i>this set of data can be iterated to specify alternative terms of payment (e.g.: 60 days or 30 days with 3% discount)</i>
progress	description of the progress of a production lot in a manufacturing process (XPath: KnitClothOrder/KCCObody/KCCOitem/progress) 0-9
refDoc	identification of a document and of an item thereof, to which the message makes reference

	<p>(XPath: KnitClothOrder/KCCObody/KCCOitem/apparelComponent/fabricComponent/refDoc) 0-1</p> <p>- note: <i>here the delivery documents can be specified</i></p> <p>(XPath: KnitClothOrder/KCCObody/KCCOitem/appMnfrOperation/refDoc) 0-1</p> <p>(XPath: KnitClothOrder/KCCOheader/refDoc) 0-9</p> <p>(XPath: KnitClothOrder/KCCObody/KCCOitem/apparelComponent/garmentPartComponent/refDoc) 0-1</p> <p>(XPath: KnitClothOrder/KCCObody/KCCOitem/apparelComponent/yarnComponent/refDoc) 0-1</p> <p>- note: <i>here the delivery document can be specified</i></p> <p>(XPath: KnitClothOrder/KCCObody/KCCOitem/garTecSheet/refDoc) 0-9</p> <p>(XPath: KnitClothOrder/KCCObody/KCCOitem/apparelComponent/acsComponent/refDoc) 0-1</p>
sizeMatrix	<p>size matrix of an apparel product (knitwear/clothing)</p> <p>(XPath: KnitClothOrder/KCCObody/KCCOitem/apparelProd/csRange/sizeMatrix) 1-1</p>
sizeRow	<p>size matrix row of an apparel product (knitwear/clothing)</p> <p>(XPath: KnitClothOrder/KCCObody/KCCOitem/apparelProd/csRange/sizeMatrix/sizeRow) 1-99</p>
subContractor	<p>details of the Sub-contractor</p> <p>- base type: ,</p> <p>(XPath: KnitClothOrder/KCCOheader/subContractor) 1-1</p>
terms	<p>details of the commercial obligations for payment and delivery</p> <p>(XPath: KnitClothOrder/terms) 0-1</p>
texCode	<p>full codification of the textile product</p> <p>(XPath: KnitClothOrder/KCCObody/KCCOitem/apparelComponent/fabricComponent/texCode) 1-1</p> <p>(XPath: KnitClothOrder/KCCObody/KCCOitem/garTecSheet/garConsumptionSet/texCode) 1-1</p>
thirdParty	<p>details of the Third Party, different from Buyer or Supplier</p> <p>- base type: ,</p> <p>(XPath: KnitClothOrder/KCCObody/KCCOitem/thirdParty) 0-5</p> <p>(XPath: KnitClothOrder/KCCOheader/thirdParty) 0-1</p> <p>- note: <i>here the Party to whom the Subcontractor must send the semi-finished products for subsequent operations can be specified</i></p>
trade	<p>general terms of trade for the specified supply</p> <p>(XPath: KnitClothOrder/terms/trade) 0-1</p>
transInfo	<p>details of transport: mode, carrier and delivery place</p> <p>(XPath: KnitClothOrder/terms/transInfo) 0-1</p>
yarnCode	<p>full codification of a yarn product</p> <p>(XPath: KnitClothOrder/KCCObody/KCCOitem/garTecSheet/garConsumptionSet/yarnCode) 1-1</p> <p>(XPath: KnitClothOrder/KCCObody/KCCOitem/apparelComponent/yarnComponent/yarnCode) 1-1</p> <p>- note: <i>here is the code of the component used in the yarn manufacturing operation</i></p>
yarnComponent	<p>identification details of a yarn used in a sub-contracted manufacturing operation</p> <p>(XPath: KnitClothOrder/KCCObody/KCCOitem/apparelComponent/yarnComponent) 0-9</p>

2.2.2 Simple elements (Basic Business Information Entities)

Simple elements are those elements whose content is characterized by a data type plus a domain of

possible values. Simple elements are alphabetically ordered.

AC_amount	amount of an Allowance or Charge - base type: decimal, fraction digits: 2, (XPath: KnitClothOrder/terms/allowanceCharge/AC_amount) 1-1
AC_category	coded specification of an Allowance or Charge - base type: string, cod. table: T41, (XPath: KnitClothOrder/terms/allowanceCharge/AC_category) 1-1
AC_categoryText	free text description of an Allowance or Charge - base type: string, max length: 70, (XPath: KnitClothOrder/terms/allowanceCharge/AC_categoryText) 1-1
AC_percent	amount of an Allowance or Charge as a percentage - base type: decimal, max inclusive: 100, fraction digits: 2, (XPath: KnitClothOrder/terms/allowanceCharge/AC_percent) 1-1
added	additional code of the product (complementing the formers) - base type: string, max length: 15, (XPath: KnitClothOrder/KCCObody/KCCOitem/garTecSheet/ garConsumptionSet/texCode/added) 0-9 - note: here an additional codification (see table T44) can be specified (XPath: KnitClothOrder/KCCObody/KCCOitem/apparelComponent/ yarnComponent/yarnCode/added) 0-9 - note: here an additional codification (see table T44) can be specified (XPath: KnitClothOrder/KCCObody/KCCOitem/apparelComponent/ fabricComponent/texCode/added) 0-9 - note: here an additional codification (see table T44) can be specified (XPath: KnitClothOrder/KCCObody/KCCOitem/garTecSheet/ garConsumptionSet/yarnCode/added) 0-9 - note: here an additional codification (see table T44) can be specified (XPath: KnitClothOrder/KCCObody/KCCOitem/apparelComponent/ acsComponent/acsCode/added) 0-9 - note: here an additional codification (see table T44) can be specified (XPath: KnitClothOrder/KCCObody/KCCOitem/apparelProd/ garmentCode/garmentCodeB/added) 0-9 (XPath: KnitClothOrder/KCCObody/KCCOitem/garTecSheet/ garmentCode/garmentCodeB/added) 0-9 (XPath: KnitClothOrder/KCCObody/KCCOitem/garTecSheet/ garConsumptionSet/acsCode/added) 0-9 - note: here an additional codification (see table T44) can be specified
@addType	qualifier of the additional coding of a product - base type: string, cod. table: T44, (XPath: KnitClothOrder/KCCObody/KCCOitem/apparelComponent/ acsComponent/acsCode/added/@addType) [Optional] (XPath: KnitClothOrder/KCCObody/KCCOitem/garTecSheet/ garmentCode/garmentCodeB/added/@addType) [Optional] (XPath: KnitClothOrder/KCCObody/KCCOitem/apparelProd/ garmentCode/garmentCodeB/added/@addType) [Optional] (XPath: KnitClothOrder/KCCObody/KCCOitem/apparelComponent/ yarnComponent/yarnCode/added/@addType) [Optional] (XPath: KnitClothOrder/KCCObody/KCCOitem/garTecSheet/ garConsumptionSet/acsCode/added/@addType) [Optional] (XPath: KnitClothOrder/KCCObody/KCCOitem/garTecSheet/ garConsumptionSet/texCode/added/@addType) [Optional] (XPath: KnitClothOrder/KCCObody/KCCOitem/garTecSheet/ garConsumptionSet/yarnCode/added/@addType) [Optional] (XPath: KnitClothOrder/KCCObody/KCCOitem/apparelComponent/ fabricComponent/texCode/added/@addType) [Optional]
appJob	operation of a work cycle for knitting/clothing - base type: string, cod. table: T205,

	(XPath: KnitClothOrder/KCCObody/KCCOitem/appMnfrOperation/appJob) 1-1
appJobTech	operation technology for knitting/clothing - base type: string, cod. table: T265, (XPath: KnitClothOrder/KCCObody/KCCOitem/appMnfrOperation/appJobTech) 0-1
appMachine	machine used in an operation of a work cycle for knitting/clothing - base type: string, cod. table: T275, (XPath: KnitClothOrder/KCCObody/KCCOitem/appMnfrOperation/appMachine) 0-1
art	article number of the product - base type: string, max length: 25, (XPath: KnitClothOrder/KCCObody/KCCOitem/apparelComponent/fabricComponent/texCode/art) 1-1 - note: <i>can be used either for the base-article (excluding pattern/colour) or for the SKU</i> (XPath: KnitClothOrder/KCCObody/KCCOitem/garTecSheet/garConsumptionSet/texCode/art) 1-1 - note: <i>can be used either for the base-article (excluding pattern/colour) or for the SKU</i> (XPath: KnitClothOrder/KCCObody/KCCOitem/apparelProd/garmentCode/garmentCodeA/art) 1-1 (XPath: KnitClothOrder/KCCObody/KCCOitem/garTecSheet/garConsumptionSet/yarnCode/art) 1-1 (XPath: KnitClothOrder/KCCObody/KCCOitem/garTecSheet/garConsumptionSet/acsCode/art) 1-1 (XPath: KnitClothOrder/KCCObody/KCCOitem/apparelComponent/acsComponent/acsCode/art) 1-1 (XPath: KnitClothOrder/KCCObody/KCCOitem/garTecSheet/garmentCode/garmentCodeA/art) 1-1 (XPath: KnitClothOrder/KCCObody/KCCOitem/apparelComponent/yarnComponent/yarnCode/art) 1-1
artGroup	code identifying a class of products - base type: string, max length: 40, (XPath: KnitClothOrder/KCCObody/KCCOitem/apparelProd/garmentCode/garmentCodeB/artGroup) 0-1 (XPath: KnitClothOrder/KCCObody/KCCOitem/garTecSheet/garmentCode/garmentCodeB/artGroup) 0-1
carrier	identification of the transport carrier - base type: string, max length: 40, (XPath: KnitClothOrder/terms/transInfo/carrier) 0-1
city	name of the city (town, village) - base type: string, max length: 40, (XPath: KnitClothOrder/KCCObody/KCCOitem/thirdParty/city) 0-1 (XPath: KnitClothOrder/KCCOheader/subContractor/city) 0-1 (XPath: KnitClothOrder/KCCOheader/thirdParty/city) 0-1 (XPath: KnitClothOrder/KCCOheader/buyer/city) 0-1
@codeList	it specifies the URL where the list of codes used to make an instance of the element can be found - base type: string, max length: 255, (XPath: KnitClothOrder/KCCObody/KCCOitem/garTecSheet/garConsumptionSet/texCode/pattern/@codeList) [Optional] - nota: <i>this attribute should be ALTERNATIVE to the others</i> (XPath: KnitClothOrder/KCCObody/KCCOitem/garTecSheet/garConsumptionSet/texCode/color/@codeList) [Optional] - nota: <i>this attribute should be ALTERNATIVE to the others</i> (XPath: KnitClothOrder/KCCObody/KCCOitem/apparelProd/csRange/color/@codeList) [Optional] - nota: <i>this attribute should be ALTERNATIVE to the others</i> (XPath: KnitClothOrder/KCCObody/KCCOitem/garTecSheet/garConsumptionSet/texCode/art/@codeList) [Optional]

- nota: *this attribute should be ALTERNATIVE to the others*
(XPath: KnitClothOrder/KCCObody/KCCOitem/apparelComponent/
fabricComponent/note/@codeList) [Optional]
- nota: *must be used to provide (URL) the list of codes used in "noteLabel"*
(XPath: KnitClothOrder/KCCObody/KCCOitem/apparelProd/
garmentCode/garmentCodeA/art/@codeList) [Optional]
- nota: *this attribute should be ALTERNATIVE to the others*
(XPath: KnitClothOrder/KCCObody/KCCOitem/apparelComponent/
garmentPartComponent/garmentPartCode/mod/@codeList) [Optional]
- nota: *this attribute should be ALTERNATIVE to the others*
(XPath: KnitClothOrder/KCCObody/KCCOitem/garTecSheet/
garConsumptionSet/yarnCode/art/@codeList) [Optional]
- nota: *this attribute should be ALTERNATIVE to the others*
(XPath: KnitClothOrder/KCCObody/KCCOitem/apparelProd/
garmentCode/garmentCodeB/mod/@codeList) [Optional]
- nota: *this attribute should be ALTERNATIVE to the others*
(XPath: KnitClothOrder/KCCObody/KCCOitem/apparelProd/
garmentCode/garmentCodeB/fabric/@codeList) [Optional]
- nota: *this attribute should be ALTERNATIVE to the others*
(XPath: KnitClothOrder/KCCObody/KCCOitem/apparelComponent/
garmentPartComponent/garmentPartCode/color/@codeList) [Optional]
- nota: *this attribute should be ALTERNATIVE to the others*
(XPath: KnitClothOrder/KCCObody/KCCOitem/apparelProd/
garmentPartCode/size/@codeList) [Optional]
(XPath: KnitClothOrder/KCCObody/KCCOitem/apparelComponent/
garmentPartComponent/garmentPartCode/size/@codeList) [Optional]
(XPath: KnitClothOrder/KCCObody/KCCOitem/garTecSheet/
garConsumptionSet/yarnCode/color/@codeList) [Optional]
- nota: *this attribute should be ALTERNATIVE to the others*
(XPath: KnitClothOrder/KCCObody/KCCOitem/apparelProd/
garmentCode/garmentCodeB/artGroup/@codeList) [Optional]
- nota: *this attribute should be ALTERNATIVE to the others*
(XPath: KnitClothOrder/KCCObody/KCCOitem/apparelProd/
garmentCode/garmentCodeB/size/@codeList) [Optional]
(XPath: KnitClothOrder/KCCObody/KCCOitem/apparelProd/
garmentCode/garmentCodeB/color/@codeList) [Optional]
- nota: *this attribute should be ALTERNATIVE to the others*
(XPath: KnitClothOrder/KCCObody/KCCOitem/apparelComponent/
garmentPartComponent/garmentPartCode/fabric/@codeList) [Optional]
- nota: *this attribute should be ALTERNATIVE to the others*
(XPath: KnitClothOrder/KCCObody/KCCOitem/garTecSheet/
garmentCode/garmentCodeB/color/@codeList) [Optional]
- nota: *this attribute should be ALTERNATIVE to the others*
(XPath: KnitClothOrder/KCCObody/KCCOitem/apparelComponent/
fabricComponent/texCode/color/@codeList) [Optional]
- nota: *this attribute should be ALTERNATIVE to the others*
(XPath: KnitClothOrder/KCCObody/KCCOitem/garTecSheet/
garmentCode/garmentCodeB/artGroup/@codeList) [Optional]
- nota: *this attribute should be ALTERNATIVE to the others*
(XPath: KnitClothOrder/KCCObody/KCCOitem/garTecSheet/
garmentCode/garmentCodeB/size/@codeList) [Optional]
(XPath: KnitClothOrder/KCCObody/KCCOitem/apparelComponent/
fabricComponent/texCode/pattern/@codeList) [Optional]
- nota: *this attribute should be ALTERNATIVE to the others*
(XPath: KnitClothOrder/KCCObody/KCCOitem/garTecSheet/
garmentCode/garmentCodeB/mod/@codeList) [Optional]
- nota: *this attribute should be ALTERNATIVE to the others*
(XPath: KnitClothOrder/KCCObody/KCCOitem/apparelComponent/
yarnComponent/note/@codeList) [Optional]
- nota: *must be used to provide (URL) the list of codes used in "noteLabel"*
(XPath: KnitClothOrder/KCCObody/KCCOitem/apparelComponent/
fabricComponent/texCode/art/@codeList) [Optional]
- nota: *this attribute should be ALTERNATIVE to the others*

	<p>(XPath: KnitClothOrder/KCCObody/KCCOitem/garTecSheet/garmentCode/garmentCodeB/fabric/@codeList) [Optional]</p> <p>- nota: <i>this attribute should be ALTERNATIVE to the others</i></p> <p>(XPath: KnitClothOrder/KCCObody/KCCOitem/garTecSheet/garmentCode/garmentCodeA/art/@codeList) [Optional]</p> <p>- nota: <i>this attribute should be ALTERNATIVE to the others</i></p> <p>(XPath: KnitClothOrder/KCCObody/KCCOitem/garTecSheet/garConsumptionSet/acsCode/pattern/@codeList) [Optional]</p> <p>- nota: <i>this attribute should be ALTERNATIVE to the others</i></p> <p>(XPath: KnitClothOrder/KCCObody/KCCOitem/garTecSheet/garConsumptionSet/acsCode/art/@codeList) [Optional]</p> <p>- nota: <i>this attribute should be ALTERNATIVE to the others</i></p> <p>(XPath: KnitClothOrder/KCCObody/KCCOitem/apparelProd/csRange/sizeMatrix/sizeRow/drop/@codeList) [Optional]</p> <p>(XPath: KnitClothOrder/KCCObody/KCCOitem/garTecSheet/garConsumptionSet/acsCode/color/@codeList) [Optional]</p> <p>- nota: <i>this attribute should be ALTERNATIVE to the others</i></p> <p>(XPath: KnitClothOrder/KCCObody/KCCOitem/apparelComponent/yarnComponent/yarnCode/art/@codeList) [Optional]</p> <p>- nota: <i>this attribute should be ALTERNATIVE to the others</i></p> <p>(XPath: KnitClothOrder/KCCObody/KCCOitem/apparelProd/csRange/sizeMatrix/sizeRow/size/@codeList) [Optional]</p> <p>(XPath: KnitClothOrder/KCCObody/KCCOitem/apparelProd/note/@codeList) [Optional]</p> <p>- nota: <i>must be used to provide (URL) the list of codes used in "noteLabel"</i></p> <p>(XPath: KnitClothOrder/KCCObody/KCCOitem/garTecSheet/garMeaSet/garMea/size/@codeList) [Optional]</p> <p>(XPath: KnitClothOrder/KCCObody/KCCOitem/apparelComponent/yarnComponent/yarnCode/color/@codeList) [Optional]</p> <p>- nota: <i>this attribute should be ALTERNATIVE to the others</i></p> <p>(XPath: KnitClothOrder/KCCObody/KCCOitem/apparelProd/garmentPartCode/fabric/@codeList) [Optional]</p> <p>- nota: <i>this attribute should be ALTERNATIVE to the others</i></p> <p>(XPath: KnitClothOrder/KCCObody/KCCOitem/apparelComponent/acsComponent/acsCode/art/@codeList) [Optional]</p> <p>- nota: <i>this attribute should be ALTERNATIVE to the others</i></p> <p>(XPath: KnitClothOrder/KCCObody/KCCOitem/apparelComponent/acsComponent/note/@codeList) [Optional]</p> <p>- nota: <i>must be used to provide (URL) the list of codes used in "noteLabel"</i></p> <p>(XPath: KnitClothOrder/KCCObody/KCCOitem/apparelComponent/acsComponent/acsCode/pattern/@codeList) [Optional]</p> <p>- nota: <i>this attribute should be ALTERNATIVE to the others</i></p> <p>(XPath: KnitClothOrder/KCCOheader/note/@codeList) [Optional]</p> <p>- nota: <i>must be used to provide (URL) the list of codes used in "noteLabel"</i></p> <p>(XPath: KnitClothOrder/KCCObody/KCCOitem/apparelComponent/acsComponent/acsCode/color/@codeList) [Optional]</p> <p>- nota: <i>this attribute should be ALTERNATIVE to the others</i></p> <p>(XPath: KnitClothOrder/KCCObody/KCCOitem/apparelComponent/garmentPartComponent/note/@codeList) [Optional]</p> <p>- nota: <i>must be used to provide (URL) the list of codes used in "noteLabel"</i></p> <p>(XPath: KnitClothOrder/KCCObody/KCCOitem/apparelProd/garmentPartCode/mod/@codeList) [Optional]</p> <p>- nota: <i>this attribute should be ALTERNATIVE to the others</i></p> <p>(XPath: KnitClothOrder/KCCObody/KCCOitem/appMnfrOperation/note/@codeList) [Optional]</p> <p>- nota: <i>must be used to provide (URL) the list of codes used in "noteLabel"</i></p> <p>(XPath: KnitClothOrder/KCCObody/KCCOitem/apparelProd/garmentPartCode/color/@codeList) [Optional]</p> <p>- nota: <i>this attribute should be ALTERNATIVE to the others</i></p>
color	<p>colour number of the product, when not included in the model or fabric code</p> <p>- base type: string, max length: 15,</p> <p>(XPath: KnitClothOrder/KCCObody/KCCOitem/apparelComponent/yarnComponent/yarnCode/color) 0-1</p>

	<p>(XPath: KnitClothOrder/KCCObody/KCCOitem/apparelComponent/acsComponent/acsCode/color) 0-1</p> <p>(XPath: KnitClothOrder/KCCObody/KCCOitem/apparelProd/garmentCode/garmentCodeB/color) 0-1</p> <p>(XPath: KnitClothOrder/KCCObody/KCCOitem/garTecSheet/garConsumptionSet/acsCode/color) 0-1</p> <p>(XPath: KnitClothOrder/KCCObody/KCCOitem/garTecSheet/garmentCode/garmentCodeB/color) 0-1</p> <p>(XPath: KnitClothOrder/KCCObody/KCCOitem/garTecSheet/garConsumptionSet/texCode/color) 0-1</p> <p>(XPath: KnitClothOrder/KCCObody/KCCOitem/apparelProd/garmentPartCode/color) 0-1</p> <p>- note: when a garment component, it should be the code assigned to the garment article</p> <p>(XPath: KnitClothOrder/KCCObody/KCCOitem/apparelComponent/garmentPartComponent/garmentPartCode/color) 0-1</p> <p>- note: when a garment component, it should be the code assigned to the garment article</p> <p>(XPath: KnitClothOrder/KCCObody/KCCOitem/garTecSheet/garConsumptionSet/yarnCode/color) 0-1</p> <p>(XPath: KnitClothOrder/KCCObody/KCCOitem/apparelComponent/fabricComponent/texCode/color) 0-1</p> <p>(XPath: KnitClothOrder/KCCObody/KCCOitem/apparelProd/csRange/color) 0-1</p>
country	<p>code of the nation</p> <p>- base type: string, cod. table: T10,</p> <p>(XPath: KnitClothOrder/KCCObody/KCCOitem/thirdParty/country) 0-1</p> <p>(XPath: KnitClothOrder/KCCOheader/thirdParty/country) 0-1</p> <p>(XPath: KnitClothOrder/KCCOheader/subContractor/country) 0-1</p> <p>(XPath: KnitClothOrder/KCCOheader/buyer/country) 0-1</p>
@CQQ	<p>specifies if the committed quantity can or can not include the loss in weight</p> <p>- base type: string, cod. table: NT37,</p> <p>(XPath: KnitClothOrder/KCCObody/KCCOitem/apparelComponent/yarnComponent/@CQQ) [Optional]</p>
customsStat	<p>statistic code assigned by Customs to a specified product</p> <p>- base type: string, max length: 15,</p> <p>(XPath: KnitClothOrder/KCCObody/KCCOitem/garTecSheet/customsStat) 0-1</p>
@dateForm	<p>format used for a date</p> <p>- base type: string, cod. table: NT29,</p> <p>(XPath: KnitClothOrder/KCCOheader/refDoc/docDate/@dateForm) [Optional]</p> <p>(XPath: KnitClothOrder/KCCObody/KCCOitem/apparelComponent/fabricComponent/refDoc/docDate/@dateForm) [Optional]</p> <p>(XPath: KnitClothOrder/KCCObody/KCCOitem/progress/deliveryDate/@dateForm) [Optional]</p> <p>(XPath: KnitClothOrder/KCCObody/KCCOitem/apparelComponent/yarnComponent/refDoc/docDate/@dateForm) [Optional]</p> <p>(XPath: KnitClothOrder/KCCObody/KCCOitem/apparelComponent/garmentPartComponent/refDoc/docDate/@dateForm) [Optional]</p> <p>(XPath: KnitClothOrder/KCCObody/KCCOitem/progress/delGrantedDate/@dateForm) [Optional]</p> <p>(XPath: KnitClothOrder/KCCObody/KCCOitem/garTecSheet/refDoc/docDate/@dateForm) [Optional]</p> <p>(XPath: KnitClothOrder/KCCObody/KCCOitem/deliveryDate/@dateForm) [Optional]</p> <p>(XPath: KnitClothOrder/KCCObody/KCCOitem/apparelComponent/acsComponent/refDoc/docDate/@dateForm) [Optional]</p> <p>(XPath: KnitClothOrder/KCCOheader/msgDate/@dateForm) [Optional]</p> <p>(XPath: KnitClothOrder/KCCObody/KCCOitem/appMnfrOperation/refDoc/docDate/@dateForm) [Optional]</p>
delGrantedDate	<p>effective date of delivery of goods (granted in the Order Status Report); incase of doubt delivery must be understood as the event when the</p>

	<p>ownership of goods is transferred, according to one of the patterns YYYY-MM-DD, YYYY-MM-DD:HH-MM or YYYY-WW.</p> <p>- base type: string, (XPath: KnitClothOrder/KCCObody/KCCOitem/progress/delGrantedDate) 0-1</p>
deliveryDate	<p>date of delivery of goods, requested or promised in the purchase process, according to one of the patterns YYYY-MM-DD, YYYY-MM-DD:HH-MM or YYYY-WW.</p> <p>- base type: string, (XPath: KnitClothOrder/KCCObody/KCCOitem/deliveryDate) 0-1 (XPath: KnitClothOrder/KCCObody/KCCOitem/progress/deliveryDate) 0-1</p>
deliveryPlace	<p>place of delivery of goods, ultimate or related to a given leg</p> <p>- base type: string, max length: 40, (XPath: KnitClothOrder/terms/transInfo/deliveryPlace) 0-1</p>
dept	<p>name or code of a contact department within a Party</p> <p>- base type: string, max length: 40, (XPath: KnitClothOrder/KCCOheader/thirdParty/dept) 0-1 (XPath: KnitClothOrder/KCCOheader/subContractor/dept) 0-1 (XPath: KnitClothOrder/KCCOheader/buyer/dept) 0-1 (XPath: KnitClothOrder/KCCObody/KCCOitem/thirdParty/dept) 0-1</p>
description	<p>free text description of a product</p> <p>- base type: string, max length: 70, (XPath: KnitClothOrder/KCCObody/KCCOitem/garTecSheet/garConsumptionSet/yarnCode/description) 0-1 (XPath: KnitClothOrder/KCCObody/KCCOitem/apparelComponent/fabricComponent/texCode/description) 0-1 (XPath: KnitClothOrder/KCCObody/KCCOitem/garTecSheet/garConsumptionSet/acsCode/description) 0-1 (XPath: KnitClothOrder/KCCObody/KCCOitem/garTecSheet/garmentCode/garmentCodeA/description) 0-1 (XPath: KnitClothOrder/KCCObody/KCCOitem/garTecSheet/garConsumptionSet/texCode/description) 0-1 (XPath: KnitClothOrder/KCCObody/KCCOitem/apparelComponent/acsComponent/acsCode/description) 0-1 (XPath: KnitClothOrder/KCCObody/KCCOitem/apparelProd/garmentCode/garmentCodeA/description) 0-1 (XPath: KnitClothOrder/KCCObody/KCCOitem/apparelProd/garmentPartCode/description) 0-1 (XPath: KnitClothOrder/KCCObody/KCCOitem/apparelComponent/garmentPartComponent/garmentPartCode/description) 0-1 (XPath: KnitClothOrder/KCCObody/KCCOitem/apparelProd/garmentCode/garmentCodeB/description) 0-1 (XPath: KnitClothOrder/KCCObody/KCCOitem/apparelComponent/yarnComponent/yarnCode/description) 0-1 (XPath: KnitClothOrder/KCCObody/KCCOitem/garTecSheet/garmentCode/garmentCodeB/description) 0-1</p>
docDate	<p>date of issue of the referenced document, according to one of the patterns YYYY-MM-DD, YYYY-MM-DD:HH-MM or YYYY-WW.</p> <p>- base type: string, (XPath: KnitClothOrder/KCCObody/KCCOitem/appMnfrOperation/refDoc/docDate) 0-1 (XPath: KnitClothOrder/KCCOheader/refDoc/docDate) 0-1 (XPath: KnitClothOrder/KCCObody/KCCOitem/garTecSheet/refDoc/docDate) 0-1 (XPath: KnitClothOrder/KCCObody/KCCOitem/apparelComponent/acsComponent/refDoc/docDate) 0-1 (XPath: KnitClothOrder/KCCObody/KCCOitem/apparelComponent/garmentPartComponent/refDoc/docDate) 0-1 (XPath: KnitClothOrder/KCCObody/KCCOitem/apparelComponent/yarnComponent/refDoc/docDate) 0-1 (XPath: KnitClothOrder/KCCObody/KCCOitem/apparelComponent/</p>

	fabricComponent/refDoc/docDate) 0-1
docID	<p>identification number of the referenced document SINCE 2008-1 ITS USE IN THE HEADER IS DISCOURAGED (REPLACED BY)</p> <p>- base type: string, max length: 35,</p> <p>(XPath: KnitClothOrder/KCCObody/KCCOitem/apparelComponent/acsComponent/refDoc/docID) 1-2</p> <p>(XPath: KnitClothOrder/KCCOheader/refDoc/docID) 1-2</p> <p>(XPath: KnitClothOrder/KCCObody/KCCOitem/garTecSheet/refDoc/docID) 1-2</p> <p>(XPath: KnitClothOrder/KCCObody/KCCOitem/apparelComponent/yarnComponent/refDoc/docID) 1-2</p> <p>(XPath: KnitClothOrder/KCCObody/KCCOitem/apparelComponent/fabricComponent/refDoc/docID) 1-2</p> <p>(XPath: KnitClothOrder/KCCObody/KCCOitem/appMnfrOperation/refDoc/docID) 1-2</p> <p>(XPath: KnitClothOrder/KCCOheader/docID) 0-1</p> <p>(XPath: KnitClothOrder/KCCObody/KCCOitem/apparelComponent/garmentPartComponent/refDoc/docID) 1-2</p>
@docType	<p>type or class to which the referenced document belongs</p> <p>- base type: string, cod. table: T21,</p> <p>(XPath: KnitClothOrder/KCCObody/KCCOitem/apparelComponent/yarnComponent/refDoc/@docType) [Required]</p> <p>(XPath: KnitClothOrder/KCCObody/KCCOitem/appMnfrOperation/refDoc/@docType) [Required]</p> <p>(XPath: KnitClothOrder/KCCObody/KCCOitem/garTecSheet/refDoc/@docType) [Required]</p> <p>(XPath: KnitClothOrder/KCCObody/KCCOitem/apparelComponent/acsComponent/refDoc/@docType) [Required]</p> <p>(XPath: KnitClothOrder/KCCOheader/refDoc/@docType) [Required]</p> <p>(XPath: KnitClothOrder/KCCObody/KCCOitem/apparelComponent/fabricComponent/refDoc/@docType) [Required]</p> <p>(XPath: KnitClothOrder/KCCObody/KCCOitem/apparelComponent/garmentPartComponent/refDoc/@docType) [Required]</p>
drop	<p>drop number of the garment</p> <p>- base type: string, max length: 15,</p> <p>(XPath: KnitClothOrder/KCCObody/KCCOitem/apparelProd/csRange/sizeMatrix/sizeRow/drop) 0-1</p>
dyeN	<p>number of the dyeing batch of a textile product</p> <p>- base type: string, max length: 15,</p> <p>(XPath: KnitClothOrder/KCCObody/KCCOitem/apparelComponent/yarnComponent/dyeN) 0-1</p> <p>(XPath: KnitClothOrder/KCCObody/KCCOitem/apparelComponent/acsComponent/dyeN) 0-1</p> <p>(XPath: KnitClothOrder/KCCObody/KCCOitem/apparelComponent/garmentPartComponent/dyeN) 0-1</p> <p>(XPath: KnitClothOrder/KCCObody/KCCOitem/apparelProd/dyeN) 0-1</p>
@email	<p>electronic mail address of the contact person within a Party</p> <p>- base type: string, max length: 80,</p> <p>(XPath: KnitClothOrder/KCCOheader/subContractor/person/@email) [Optional]</p> <p>(XPath: KnitClothOrder/KCCOheader/thirdParty/person/@email) [Optional]</p> <p>(XPath: KnitClothOrder/KCCOheader/buyer/person/@email) [Optional]</p> <p>(XPath: KnitClothOrder/KCCObody/KCCOitem/thirdParty/person/@email) [Optional]</p>
fabric	<p>fabric number of the garment</p> <p>- base type: string, max length: 15,</p> <p>(XPath: KnitClothOrder/KCCObody/KCCOitem/apparelComponent/garmentPartComponent/garmentPartCode/fabric) 0-1</p> <p>- note: <i>when a garment component, it should be the code assigned to the garment article</i></p> <p>(XPath: KnitClothOrder/KCCObody/KCCOitem/apparelProd/</p>

	<p>garmentPartCode/fabric) 0-1</p> <p>- note: when a garment component, it should be the code assigned to the garment article</p> <p>(XPath: KnitClothOrder/KCCObody/KCCOitem/garTecSheet/garmentCode/garmentCodeB/fabric) 0-1</p> <p>(XPath: KnitClothOrder/KCCObody/KCCOitem/apparelProd/garmentCode/garmentCodeB/fabric) 0-1</p>
@fax	<p>fax number of the contact person within a Party</p> <p>- base type: string, max length: 35,</p> <p>(XPath: KnitClothOrder/KCCOheader/thirdParty/person/@fax) [Optional]</p> <p>(XPath: KnitClothOrder/KCCOheader/buyer/person/@fax) [Optional]</p> <p>(XPath: KnitClothOrder/KCCOheader/subContractor/person/@fax) [Optional]</p> <p>(XPath: KnitClothOrder/KCCObody/KCCOitem/thirdParty/person/@fax) [Optional]</p>
@fibre	<p>type of fibre used in a textile product</p> <p>- base type: string, cod. table: T19,</p> <p>(XPath: KnitClothOrder/KCCObody/KCCOitem/garTecSheet/fabricCompos/percCompos/@fibre) [Required]</p>
@finDiscount	<p>financial discount applied for payment by the date specified</p> <p>- base type: decimal, min inclusive: 0, max inclusive: 100, fraction digits: 2,</p> <p>(XPath: KnitClothOrder/terms/payment/@finDiscount) [Optional]</p>
@finSurcharge	<p>financial surcharge applied for payment after the date specified</p> <p>- base type: decimal, min inclusive: 0, max inclusive: 100, fraction digits: 2,</p> <p>(XPath: KnitClothOrder/terms/payment/@finSurcharge) [Optional]</p>
garAttrib	<p>garment's attribute to which the measures are referred</p> <p>- base type: string, cod. table: NT41,</p> <p>(XPath: KnitClothOrder/KCCObody/KCCOitem/garTecSheet/garMeaSet/garAttrib) 1-1</p>
garSizeCode	<p>code of a range of sizes</p> <p>- base type: string, max length: 15,</p> <p>(XPath: KnitClothOrder/KCCObody/KCCOitem/garTecSheet/garConsumptionSet/garConsumption/garSizeCode) 0-1</p> <p>(XPath: KnitClothOrder/KCCObody/KCCOitem/garTecSheet/garSizeSet/garSizeTier/garSizeCode) 1-1</p>
gPart	<p>code specifying the type of component or part of a garment (sleeve, neck, ...)</p> <p>- base type: string, cod. table: T48,</p> <p>(XPath: KnitClothOrder/KCCObody/KCCOitem/apparelProd/garmentPartCode/gPart) 1-1</p> <p>(XPath: KnitClothOrder/KCCObody/KCCOitem/apparelComponent/gPart) 0-1</p> <p>(XPath: KnitClothOrder/KCCObody/KCCOitem/apparelComponent/garmentPartComponent/garmentPartCode/gPart) 1-1</p>
grossWeight	<p>the gross weight of the overall goods supply, declared for transport or customs purpose</p> <p>- base type: decimal, min inclusive: 0, fraction digits: 2,</p> <p>(XPath: KnitClothOrder/terms/transInfo/grossWeight) 0-1</p> <p>(XPath: KnitClothOrder/KCCObody/KCCOitem/garTecSheet/grossWeight) 0-1</p>
id	<p>primary identification code of a Party; it is recommended the format: nation code (ISO 3166) + VAT identification number (11 crt), with the qualifier "numberingOrg"= MF</p> <p>- base type: string, max length: 15,</p> <p>(XPath: KnitClothOrder/KCCObody/KCCOitem/thirdParty/id) 1-1</p> <p>(XPath: KnitClothOrder/KCCOheader/buyer/id) 1-1</p> <p>(XPath: KnitClothOrder/KCCOheader/thirdParty/id) 1-1</p> <p>(XPath: KnitClothOrder/KCCOheader/subContractor/id) 1-1</p>
image	<p>URL address of an annexed image</p> <p>- base type: string, max length: 240,</p>

	(XPath: KnitClothOrder/KCCObody/KCCOitem/garTecSheet/image) 0-99
incoTerm	specification of the terms of trade (INCOTERMS) - base type: string, cod. table: T3, (XPath: KnitClothOrder/terms/trade/incoTerm) 1-1
incoTermText	free text specifying the terms of trade (incoterm, location) - base type: string, max length: 70, (XPath: KnitClothOrder/terms/trade/incoTermText) 1-1
itemID	number of the line/item of the referenced document - base type: string, max length: 6, (XPath: KnitClothOrder/KCCOheader/refDoc/itemID) 0-1 (XPath: KnitClothOrder/KCCObody/KCCOitem/garTecSheet/ refDoc/itemID) 0-1 (XPath: KnitClothOrder/KCCObody/KCCOitem/apparelComponent/ yarnComponent/refDoc/itemID) 0-1 (XPath: KnitClothOrder/KCCObody/KCCOitem/appMnfrOperation/ refDoc/itemID) 0-1 (XPath: KnitClothOrder/KCCObody/KCCOitem/apparelComponent/ garmentPartComponent/refDoc/itemID) 0-1 (XPath: KnitClothOrder/KCCObody/KCCOitem/apparelComponent/ acsComponent/refDoc/itemID) 0-1 (XPath: KnitClothOrder/KCCObody/KCCOitem/apparelComponent/ fabricComponent/refDoc/itemID) 0-1
jobName	description of the elementary job - base type: string, max length: 40, (XPath: KnitClothOrder/KCCObody/KCCOitem/appMnfrOperation/jobName) 1-1
legalName	legal name of a Party - base type: string, max length: 80, (XPath: KnitClothOrder/KCCObody/KCCOitem/thirdParty/legalName) 0-1 (XPath: KnitClothOrder/KCCOheader/buyer/legalName) 0-1 (XPath: KnitClothOrder/KCCOheader/subContractor/legalName) 0-1 (XPath: KnitClothOrder/KCCOheader/thirdParty/legalName) 0-1
lineN	number of the line item of the present message (xml document) - base type: positiveInteger, min inclusive: 1, max inclusive: 9999, (XPath: KnitClothOrder/KCCObody/KCCOitem/lineN) 1-1
@listName	it specifies the name of the list of codes used to make an instance of the element - base type: string, max length: 40, (XPath: KnitClothOrder/KCCObody/KCCOitem/apparelComponent/ yarnComponent/yarnCode/art/@listName) [Optional] - nota: <i>this attribute should always be used coupled with “numberingOrg”</i> (XPath: KnitClothOrder/KCCObody/KCCOitem/apparelProd/ garmentCode/garmentCodeB/color/@listName) [Optional] - nota: <i>this attribute should always be used coupled with “numberingOrg”</i> (XPath: KnitClothOrder/KCCObody/KCCOitem/garTecSheet/ garConsumptionSet/acsCode/pattern/@listName) [Optional] - nota: <i>this attribute should always be used coupled with “numberingOrg”</i> (XPath: KnitClothOrder/KCCObody/KCCOitem/garTecSheet/ garConsumptionSet/yarnCode/color/@listName) [Optional] - nota: <i>this attribute should always be used coupled with “numberingOrg”</i> (XPath: KnitClothOrder/KCCObody/KCCOitem/apparelProd/ garmentCode/garmentCodeB/fabric/@listName) [Optional] - nota: <i>this attribute should always be used coupled with “numberingOrg”</i> (XPath: KnitClothOrder/KCCObody/KCCOitem/garTecSheet/ garConsumptionSet/yarnCode/art/@listName) [Optional] - nota: <i>this attribute should always be used coupled with “numberingOrg”</i> (XPath: KnitClothOrder/KCCObody/KCCOitem/apparelProd/ garmentCode/garmentCodeB/mod/@listName) [Optional] - nota: <i>this attribute should always be used coupled with “numberingOrg”</i>

(XPath: KnitClothOrder/KCCObody/KCCOitem/apparelComponent/garmentPartComponent/garmentPartCode/color/@listName) [Optional]

- nota: *this attribute should always be used coupled with “numberingOrg”*

(XPath: KnitClothOrder/KCCObody/KCCOitem/apparelComponent/garmentPartComponent/garmentPartCode/fabric/@listName) [Optional]

- nota: *this attribute should always be used coupled with “numberingOrg”*

(XPath: KnitClothOrder/KCCObody/KCCOitem/apparelProd/garmentPartCode/fabric/@listName) [Optional]

- nota: *this attribute should always be used coupled with “numberingOrg”*

(XPath: KnitClothOrder/KCCObody/KCCOitem/apparelComponent/yarnComponent/yarnCode/color/@listName) [Optional]

- nota: *this attribute should always be used coupled with “numberingOrg”*

(XPath: KnitClothOrder/KCCObody/KCCOitem/garTecSheet/garConsumptionSet/acsCode/art/@listName) [Optional]

- nota: *this attribute should always be used coupled with “numberingOrg”*

(XPath: KnitClothOrder/KCCObody/KCCOitem/apparelProd/garmentPartCode/color/@listName) [Optional]

- nota: *this attribute should always be used coupled with “numberingOrg”*

(XPath: KnitClothOrder/KCCObody/KCCOitem/garTecSheet/garmentCode/garmentCodeB/mod/@listName) [Optional]

- nota: *this attribute should always be used coupled with “numberingOrg”*

(XPath: KnitClothOrder/KCCObody/KCCOitem/apparelComponent/acsComponent/acsCode/pattern/@listName) [Optional]

- nota: *this attribute should always be used coupled with “numberingOrg”*

(XPath: KnitClothOrder/KCCObody/KCCOitem/garTecSheet/garmentCode/garmentCodeB/fabric/@listName) [Optional]

- nota: *this attribute should always be used coupled with “numberingOrg”*

(XPath: KnitClothOrder/KCCObody/KCCOitem/garTecSheet/garmentCode/garmentCodeB/color/@listName) [Optional]

- nota: *this attribute should always be used coupled with “numberingOrg”*

(XPath: KnitClothOrder/KCCObody/KCCOitem/apparelProd/csRange/color/@listName) [Optional]

- nota: *this attribute should always be used coupled with “numberingOrg”*

(XPath: KnitClothOrder/KCCObody/KCCOitem/garTecSheet/garConsumptionSet/texCode/art/@listName) [Optional]

- nota: *this attribute should always be used coupled with “numberingOrg”*

(XPath: KnitClothOrder/KCCObody/KCCOitem/garTecSheet/garConsumptionSet/texCode/pattern/@listName) [Optional]

- nota: *this attribute should always be used coupled with “numberingOrg”*

(XPath: KnitClothOrder/KCCObody/KCCOitem/apparelComponent/fabricComponent/texCode/pattern/@listName) [Optional]

- nota: *this attribute should always be used coupled with “numberingOrg”*

(XPath: KnitClothOrder/KCCObody/KCCOitem/apparelComponent/fabricComponent/texCode/art/@listName) [Optional]

- nota: *this attribute should always be used coupled with “numberingOrg”*

(XPath: KnitClothOrder/KCCObody/KCCOitem/apparelComponent/fabricComponent/texCode/color/@listName) [Optional]

- nota: *this attribute should always be used coupled with “numberingOrg”*

(XPath: KnitClothOrder/KCCObody/KCCOitem/apparelComponent/acsComponent/acsCode/art/@listName) [Optional]

- nota: *this attribute should always be used coupled with “numberingOrg”*

(XPath: KnitClothOrder/KCCObody/KCCOitem/garTecSheet/garmentCode/garmentCodeA/art/@listName) [Optional]

- nota: *this attribute should always be used coupled with “numberingOrg”*

(XPath: KnitClothOrder/KCCObody/KCCOitem/apparelProd/garmentCode/garmentCodeA/art/@listName) [Optional]

- nota: *this attribute should always be used coupled with “numberingOrg”*

(XPath: KnitClothOrder/KCCObody/KCCOitem/apparelComponent/garmentPartComponent/garmentPartCode/mod/@listName) [Optional]

- nota: *this attribute should always be used coupled with “numberingOrg”*

(XPath: KnitClothOrder/KCCObody/KCCOitem/garTecSheet/garConsumptionSet/acsCode/color/@listName) [Optional]

- nota: *this attribute should always be used coupled with “numberingOrg”*

	<p>(XPath: KnitClothOrder/KCCObody/KCCOitem/apparelProd/garmentCode/garmentCodeB/artGroup/@listName) [Optional]</p> <p>- nota: <i>this attribute should always be used coupled with “numberingOrg”</i></p> <p>(XPath: KnitClothOrder/KCCObody/KCCOitem/apparelProd/garmentPartCode/mod/@listName) [Optional]</p> <p>- nota: <i>this attribute should always be used coupled with “numberingOrg”</i></p> <p>(XPath: KnitClothOrder/KCCObody/KCCOitem/garTecSheet/garConsumptionSet/texCode/color/@listName) [Optional]</p> <p>- nota: <i>this attribute should always be used coupled with “numberingOrg”</i></p> <p>(XPath: KnitClothOrder/KCCObody/KCCOitem/garTecSheet/garmentCode/garmentCodeB/artGroup/@listName) [Optional]</p> <p>- nota: <i>this attribute should always be used coupled with “numberingOrg”</i></p> <p>(XPath: KnitClothOrder/KCCObody/KCCOitem/apparelComponent/acsComponent/acsCode/color/@listName) [Optional]</p> <p>- nota: <i>this attribute should always be used coupled with “numberingOrg”</i></p>
@listVersion	<p>it specifies the version of the list of codes used to make an instance of the element</p> <p>- base type: string, max length: 6,</p> <p>(XPath: KnitClothOrder/KCCObody/KCCOitem/garTecSheet/garConsumptionSet/acsCode/pattern/@listVersion) [Optional]</p> <p>- nota: <i>this attribute should always be used coupled with “numberingOrg” and “listName”</i></p> <p>(XPath: KnitClothOrder/KCCObody/KCCOitem/garTecSheet/garConsumptionSet/yarnCode/art/@listVersion) [Optional]</p> <p>- nota: <i>this attribute should always be used coupled with “numberingOrg” and “listName”</i></p> <p>(XPath: KnitClothOrder/KCCObody/KCCOitem/garTecSheet/garConsumptionSet/acsCode/color/@listVersion) [Optional]</p> <p>- nota: <i>this attribute should always be used coupled with “numberingOrg” and “listName”</i></p> <p>(XPath: KnitClothOrder/KCCObody/KCCOitem/garTecSheet/garConsumptionSet/texCode/art/@listVersion) [Optional]</p> <p>- nota: <i>this attribute should always be used coupled with “numberingOrg” and “listName”</i></p> <p>(XPath: KnitClothOrder/KCCObody/KCCOitem/garTecSheet/garConsumptionSet/yarnCode/color/@listVersion) [Optional]</p> <p>- nota: <i>this attribute should always be used coupled with “numberingOrg” and “listName”</i></p> <p>(XPath: KnitClothOrder/KCCObody/KCCOitem/garTecSheet/garConsumptionSet/texCode/color/@listVersion) [Optional]</p> <p>- nota: <i>this attribute should always be used coupled with “numberingOrg” and “listName”</i></p> <p>(XPath: KnitClothOrder/KCCObody/KCCOitem/garTecSheet/garConsumptionSet/texCode/pattern/@listVersion) [Optional]</p> <p>- nota: <i>this attribute should always be used coupled with “numberingOrg” and “listName”</i></p> <p>(XPath: KnitClothOrder/KCCObody/KCCOitem/apparelProd/garmentCode/garmentCodeA/art/@listVersion) [Optional]</p> <p>- nota: <i>this attribute should always be used coupled with “numberingOrg” and “listName”</i></p> <p>(XPath: KnitClothOrder/KCCObody/KCCOitem/apparelProd/csRange/color/@listVersion) [Optional]</p> <p>- nota: <i>this attribute should always be used coupled with “numberingOrg” and “listName”</i></p> <p>(XPath: KnitClothOrder/KCCObody/KCCOitem/apparelProd/garmentCode/garmentCodeB/artGroup/@listVersion) [Optional]</p> <p>- nota: <i>this attribute should always be used coupled with “numberingOrg” and “listName”</i></p> <p>(XPath: KnitClothOrder/KCCObody/KCCOitem/apparelComponent/garmentPartComponent/garmentPartCode/mod/@listVersion) [Optional]</p> <p>- nota: <i>this attribute should always be used coupled with “numberingOrg” and “listName”</i></p>

	<p>(XPath: KnitClothOrder/KCCObody/KCCOitem/apparelComponent/fabricComponent/texCode/art/@listVersion) [Optional]</p> <p>- nota: <i>this attribute should always be used coupled with “numberingOrg” and “listName”</i></p> <p>(XPath: KnitClothOrder/KCCObody/KCCOitem/apparelComponent/acsComponent/acsCode/art/@listVersion) [Optional]</p> <p>- nota: <i>this attribute should always be used coupled with “numberingOrg” and “listName”</i></p> <p>(XPath: KnitClothOrder/KCCObody/KCCOitem/apparelComponent/fabricComponent/texCode/color/@listVersion) [Optional]</p> <p>- nota: <i>this attribute should always be used coupled with “numberingOrg” and “listName”</i></p> <p>(XPath: KnitClothOrder/KCCObody/KCCOitem/apparelComponent/fabricComponent/texCode/pattern/@listVersion) [Optional]</p> <p>- nota: <i>this attribute should always be used coupled with “numberingOrg” and “listName”</i></p> <p>(XPath: KnitClothOrder/KCCObody/KCCOitem/apparelProd/garmentCode/garmentCodeB/mod/@listVersion) [Optional]</p> <p>- nota: <i>this attribute should always be used coupled with “numberingOrg” and “listName”</i></p> <p>(XPath: KnitClothOrder/KCCObody/KCCOitem/apparelComponent/garmentPartComponent/garmentPartCode/fabric/@listVersion) [Optional]</p> <p>- nota: <i>this attribute should always be used coupled with “numberingOrg” and “listName”</i></p> <p>(XPath: KnitClothOrder/KCCObody/KCCOitem/apparelProd/garmentPartCode/color/@listVersion) [Optional]</p> <p>- nota: <i>this attribute should always be used coupled with “numberingOrg” and “listName”</i></p> <p>(XPath: KnitClothOrder/KCCObody/KCCOitem/apparelComponent/garmentPartComponent/garmentPartCode/color/@listVersion) [Optional]</p> <p>- nota: <i>this attribute should always be used coupled with “numberingOrg” and “listName”</i></p> <p>(XPath: KnitClothOrder/KCCObody/KCCOitem/apparelProd/garmentCode/garmentCodeB/color/@listVersion) [Optional]</p> <p>- nota: <i>this attribute should always be used coupled with “numberingOrg” and “listName”</i></p> <p>(XPath: KnitClothOrder/KCCObody/KCCOitem/apparelProd/garmentPartCode/mod/@listVersion) [Optional]</p> <p>- nota: <i>this attribute should always be used coupled with “numberingOrg” and “listName”</i></p> <p>(XPath: KnitClothOrder/KCCObody/KCCOitem/apparelProd/garmentPartCode/fabric/@listVersion) [Optional]</p> <p>- nota: <i>this attribute should always be used coupled with “numberingOrg” and “listName”</i></p> <p>(XPath: KnitClothOrder/KCCObody/KCCOitem/apparelProd/garmentCode/garmentCodeB/fabric/@listVersion) [Optional]</p> <p>- nota: <i>this attribute should always be used coupled with “numberingOrg” and “listName”</i></p> <p>(XPath: KnitClothOrder/KCCObody/KCCOitem/apparelComponent/acsComponent/acsCode/color/@listVersion) [Optional]</p> <p>- nota: <i>this attribute should always be used coupled with “numberingOrg” and “listName”</i></p> <p>(XPath: KnitClothOrder/KCCObody/KCCOitem/garTecSheet/garmentCode/garmentCodeB/artGroup/@listVersion) [Optional]</p> <p>- nota: <i>this attribute should always be used coupled with “numberingOrg” and “listName”</i></p> <p>(XPath: KnitClothOrder/KCCObody/KCCOitem/garTecSheet/garmentCode/garmentCodeB/fabric/@listVersion) [Optional]</p> <p>- nota: <i>this attribute should always be used coupled with “numberingOrg” and “listName”</i></p> <p>(XPath: KnitClothOrder/KCCObody/KCCOitem/garTecSheet/garmentCode/garmentCodeB/color/@listVersion) [Optional]</p> <p>- nota: <i>this attribute should always be used coupled with “numberingOrg”</i></p>
--	--

	<p>and "listName" (XPath: KnitClothOrder/KCCObody/KCCOitem/apparelComponent/yarnComponent/yarnCode/art/@listVersion) [Optional] - nota: <i>this attribute should always be used coupled with "numberingOrg" and "listName"</i> (XPath: KnitClothOrder/KCCObody/KCCOitem/garTecSheet/garConsumptionSet/acsCode/art/@listVersion) [Optional] - nota: <i>this attribute should always be used coupled with "numberingOrg" and "listName"</i> (XPath: KnitClothOrder/KCCObody/KCCOitem/garTecSheet/garmentCode/garmentCodeA/art/@listVersion) [Optional] - nota: <i>this attribute should always be used coupled with "numberingOrg" and "listName"</i> (XPath: KnitClothOrder/KCCObody/KCCOitem/apparelComponent/yarnComponent/yarnCode/color/@listVersion) [Optional] - nota: <i>this attribute should always be used coupled with "numberingOrg" and "listName"</i> (XPath: KnitClothOrder/KCCObody/KCCOitem/apparelComponent/acsComponent/acsCode/pattern/@listVersion) [Optional] - nota: <i>this attribute should always be used coupled with "numberingOrg" and "listName"</i> (XPath: KnitClothOrder/KCCObody/KCCOitem/garTecSheet/garmentCode/garmentCodeB/mod/@listVersion) [Optional] - nota: <i>this attribute should always be used coupled with "numberingOrg" and "listName"</i></p>
location	<p>specification of a location - base type: string, max length: 40, (XPath: KnitClothOrder/KCCObody/KCCOitem/apparelComponent/fabricComponent/location) 0-1 - note: <i>it may be used to specify the location where lie the pieces that the Subcontractor must use for the commissioned work operation</i> (XPath: KnitClothOrder/KCCObody/KCCOitem/apparelComponent/garmentPartComponent/location) 0-1 (XPath: KnitClothOrder/KCCObody/KCCOitem/apparelComponent/yarnComponent/location) 0-1 - note: <i>here the storage place of the component can be specified</i> (XPath: KnitClothOrder/terms/trade/location) 0-1 - note: <i>place to which the INCOTERM applies</i> (XPath: KnitClothOrder/KCCObody/KCCOitem/apparelComponent/acsComponent/location) 0-1</p>
@logo	<p>company logo (URL of the image jpeg or gif). It is recommended that the width of the image does not exceed 640 pixel. - base type: string, max length: 255, (XPath: KnitClothOrder/KCCOheader/buyer/@logo) [Optional]</p>
lotN	<p>lot number of a product or batch number of the raw material - base type: string, max length: 15, (XPath: KnitClothOrder/KCCObody/KCCOitem/apparelComponent/yarnComponent/lotN) 0-1 (XPath: KnitClothOrder/KCCObody/KCCOitem/apparelComponent/garmentPartComponent/lotN) 0-1 (XPath: KnitClothOrder/KCCObody/KCCOitem/apparelProd/lotN) 0-1 (XPath: KnitClothOrder/KCCObody/KCCOitem/apparelComponent/acsComponent/lotN) 0-1</p>
@LRI	<p>attribute usable to format a string according to a customized User rule (local rule) - base type: string, cod. table: NT3, (XPath: KnitClothOrder/KCCObody/KCCOitem/apparelComponent/fabricComponent/location/@LRI) [Optional] (XPath: KnitClothOrder/KCCObody/KCCOitem/apparelComponent/acsComponent/location/@LRI) [Optional]</p>

	(XPath: KnitClothOrder/KCCObody/KCCOitem/apparelComponent/yarnComponent/location/@LRI) [Optional] (XPath: KnitClothOrder/terms/trade/location/@LRI) [Optional] (XPath: KnitClothOrder/KCCObody/KCCOitem/apparelComponent/garmentPartComponent/location/@LRI) [Optional]
@method	standard protocol or method employed in a test to evaluate a characteristic or a parameter - base type: string, max length: 25, (XPath: KnitClothOrder/KCCObody/KCCOitem/garTecSheet/garMeaSet/garMea/specValue/@method) [Optional]
mfrStatus	code of the manufacturing stage used to describe the progress in the production cycle - base type: string, cod. table: T7, (XPath: KnitClothOrder/KCCObody/KCCOitem/progress/mfrStatus) 0-1
mfrStatusText	free text description of the manufacturing stage used to specify the progress in the production cycle - base type: string, max length: 40, (XPath: KnitClothOrder/KCCObody/KCCOitem/progress/mfrStatusText) 0-1
mnfrNote	free text manufacturing note - base type: string, max length: 350, (XPath: KnitClothOrder/KCCObody/KCCOitem/garTecSheet/mnfrNote) 0-99
mod	model number of the garment - base type: string, max length: 15, (XPath: KnitClothOrder/KCCObody/KCCOitem/apparelProd/garmentPartCode/mod) 1-1 - note: <i>when a garment component, it should be the code assigned to the garment article</i> (XPath: KnitClothOrder/KCCObody/KCCOitem/apparelComponent/garmentPartComponent/garmentPartCode/mod) 1-1 - note: <i>when a garment component, it should be the code assigned to the garment article</i> (XPath: KnitClothOrder/KCCObody/KCCOitem/apparelProd/garmentCode/garmentCodeB/mod) 1-1 (XPath: KnitClothOrder/KCCObody/KCCOitem/garTecSheet/garmentCode/garmentCodeB/mod) 1-1
msgCurrency	currency used to express the monetary amounts of the message - base type: string, cod. table: T9, (XPath: KnitClothOrder/KCCOheader/msgCurrency) 0-1
msgDate	date of issue of the present message (xml document), according to one of the patterns YYYY-MM-DD, YYYY-MM-DD:HH-MM or YYYY-WW. - base type: string, (XPath: KnitClothOrder/KCCOheader/msgDate) 1-1
@msgfunction	function performed by the present message with regards to the transmission - base type: string, cod. table: NT18, (XPath: KnitClothOrder/@msgfunction) [Optional] [Default= OR]
msgID	key identifier of the document in the information system of the issuing Party - base type: string, max length: 35, (XPath: KnitClothOrder/KCCOheader/msgID) 0-1
msgN	identification number given to the message (xml document) by its issuer - base type: string, max length: 35, (XPath: KnitClothOrder/KCCOheader/msgN) 1-1
netWeight	the net weight of the overall goods supply, declared for transport or customs purpose - base type: decimal, min inclusive: 0, fraction digits: 2, (XPath: KnitClothOrder/KCCObody/KCCOitem/garTecSheet/netWeight) 0-1

	(XPath: KnitClothOrder/terms/transInfo/netWeight) 0-1
note	<p>free text or structured (computer processing) note. For note structuring use the attributes "noteLabel" and "codelist"</p> <ul style="list-style-type: none"> - base type: string, max length: 350, (XPath: KnitClothOrder/KCCOheader/note) 0-1 (XPath: KnitClothOrder/KCCObody/KCCOitem/apparelComponent/acsComponent/note) 0-1 (XPath: KnitClothOrder/KCCObody/KCCOitem/appMnfrOperation/note) 0-1 (XPath: KnitClothOrder/KCCObody/KCCOitem/apparelComponent/fabricComponent/note) 0-1 (XPath: KnitClothOrder/KCCObody/KCCOitem/apparelComponent/garmentPartComponent/note) 0-1 (XPath: KnitClothOrder/KCCObody/KCCOitem/apparelComponent/yarnComponent/note) 0-1 (XPath: KnitClothOrder/KCCObody/KCCOitem/apparelProd/note) 0-1
@noteLabel	<p>subject qualifier of a note</p> <ul style="list-style-type: none"> - base type: string, max length: 35, (XPath: KnitClothOrder/KCCOheader/note/@noteLabel) [Optional] - nota: <i>must be used to qualify the subject of the note</i> (XPath: KnitClothOrder/KCCObody/KCCOitem/apparelComponent/yarnComponent/note/@noteLabel) [Optional] - nota: <i>must be used to qualify the subject of the note</i> (XPath: KnitClothOrder/KCCObody/KCCOitem/apparelComponent/acsComponent/note/@noteLabel) [Optional] - nota: <i>must be used to qualify the subject of the note</i> (XPath: KnitClothOrder/KCCObody/KCCOitem/apparelProd/note/@noteLabel) [Optional] - nota: <i>must be used to qualify the subject of the note</i> (XPath: KnitClothOrder/KCCObody/KCCOitem/appMnfrOperation/note/@noteLabel) [Optional] - nota: <i>must be used to qualify the subject of the note</i> (XPath: KnitClothOrder/KCCObody/KCCOitem/apparelComponent/garmentPartComponent/note/@noteLabel) [Optional] - nota: <i>must be used to qualify the subject of the note</i> (XPath: KnitClothOrder/KCCObody/KCCOitem/apparelComponent/fabricComponent/note/@noteLabel) [Optional] - nota: <i>must be used to qualify the subject of the note</i>
@numberingOrg	<p>code specifying the organisation who has created or owns the coding or numbering system</p> <ul style="list-style-type: none"> - base type: string, cod. table: NT6, (XPath: KnitClothOrder/KCCObody/KCCOitem/apparelProd/garmentCode/garmentCodeB/color/@numberingOrg) [Optional] - nota: <i>this attribute should be used either single or coupled with "listName" and "listVersion"</i> (XPath: KnitClothOrder/KCCObody/KCCOitem/apparelProd/garmentCode/garmentCodeA/art/@numberingOrg) [Optional] - nota: <i>this attribute should be used either single or coupled with "listName" and "listVersion"</i> (XPath: KnitClothOrder/KCCObody/KCCOitem/apparelProd/garmentCode/garmentCodeB/artGroup/@numberingOrg) [Optional] - nota: <i>this attribute should be used either single or coupled with "listName" and "listVersion"</i> (XPath: KnitClothOrder/KCCObody/KCCOitem/apparelComponent/garmentPartComponent/garmentPartCode/fabric/@numberingOrg) [Optional] - nota: <i>this attribute should be used either single or coupled with "listName" and "listVersion"</i> (XPath: KnitClothOrder/KCCObody/KCCOitem/apparelProd/garmentCode/@numberingOrg) [Optional] (XPath: KnitClothOrder/KCCObody/KCCOitem/apparelProd/garmentPartCode/color/@numberingOrg) [Optional]

- nota: *this attribute should be used either single or coupled with “listName” and “listVersion”*
(XPath: KnitClothOrder/KCCObody/KCCOitem/apparelComponent/garmentPartComponent/lotN/@numberingOrg) [Optional]

(XPath: KnitClothOrder/KCCObody/KCCOitem/apparelProd/garmentCode/garmentCodeB/@numberingOrg) [Optional]

(XPath: KnitClothOrder/KCCObody/KCCOitem/apparelProd/garmentCode/garmentCodeB/fabric/@numberingOrg) [Optional]

- nota: *this attribute should be used either single or coupled with “listName” and “listVersion”*
(XPath: KnitClothOrder/KCCObody/KCCOitem/apparelProd/garmentCode/garmentCodeB/mod/@numberingOrg) [Optional]

- nota: *this attribute should be ALTERNATIVE to the others*
(XPath: KnitClothOrder/KCCObody/KCCOitem/apparelComponent/garmentPartComponent/garmentPartCode/color/@numberingOrg) [Optional]

- nota: *this attribute should be used either single or coupled with “listName” and “listVersion”*
(XPath: KnitClothOrder/KCCObody/KCCOitem/apparelComponent/fabricComponent/serialN/@numberingOrg) [Optional]

- nota: *here the issuer of the serial number must be specified (when different from the Supplier)*
(XPath: KnitClothOrder/KCCObody/KCCOitem/apparelComponent/fabricComponent/refDoc/docID/@numberingOrg) [Optional]

- nota: *here can be specified whose document numbering is used (e.g.: Client, Supplier, ..)*
(XPath: KnitClothOrder/KCCObody/KCCOitem/apparelProd/csRange/color/@numberingOrg) [Optional]

- nota: *this attribute should be used either single or coupled with “listName” and “listVersion”*
(XPath: KnitClothOrder/KCCObody/KCCOitem/thirdParty/id/@numberingOrg) [Optional]

(XPath: KnitClothOrder/KCCObody/KCCOitem/apparelComponent/fabricComponent/texCode/color/@numberingOrg) [Optional]

- nota: *this attribute should be used either single or coupled with “listName” and “listVersion”*
(XPath: KnitClothOrder/KCCObody/KCCOitem/apparelProd/note/@numberingOrg) [Optional]

(XPath: KnitClothOrder/KCCObody/KCCOitem/apparelComponent/garmentPartComponent/garmentPartCode/mod/@numberingOrg) [Optional]

- nota: *this attribute should be ALTERNATIVE to the others*
(XPath: KnitClothOrder/KCCObody/KCCOitem/apparelProd/dyeN/@numberingOrg) [Optional]

(XPath: KnitClothOrder/KCCObody/KCCOitem/apparelProd/lotN/@numberingOrg) [Optional]

(XPath: KnitClothOrder/KCCObody/KCCOitem/apparelComponent/fabricComponent/note/@numberingOrg) [Optional]

(XPath: KnitClothOrder/KCCObody/KCCOitem/apparelProd/csRange/@numberingOrg) [Optional]

(XPath: KnitClothOrder/KCCObody/KCCOitem/apparelComponent/garmentPartComponent/garmentPartCode/@numberingOrg) [Optional]

(XPath: KnitClothOrder/KCCObody/KCCOitem/apparelComponent/acsComponent/dyeN/@numberingOrg) [Optional]

(XPath: KnitClothOrder/KCCObody/KCCOitem/apparelComponent/acsComponent/refDoc/docID/@numberingOrg) [Optional]

- nota: *here can be specified whose document numbering is used (e.g.: Client, Supplier, ..)*
(XPath: KnitClothOrder/KCCOheader/thirdParty/id/@numberingOrg) [Optional]

(XPath: KnitClothOrder/KCCOheader/note/@numberingOrg) [Optional]

(XPath: KnitClothOrder/KCCObody/KCCOitem/garTecSheet/garConsumptionSet/texCode/color/@numberingOrg) [Optional]

- nota: *this attribute should be used either single or coupled with “listName” and “listVersion”*
(XPath: KnitClothOrder/KCCObody/KCCOitem/apparelComponent/

	<p>acsComponent/lotN/@numberingOrg) [Optional] (XPath: KnitClothOrder/KCCObody/KCCOitem/garTecSheet/ garConsumptionSet/yarnCode/@numberingOrg) [Optional] [Default= CL] (XPath: KnitClothOrder/KCCObody/KCCOitem/appMnfrOperation/ refDoc/docID/@numberingOrg) [Optional] - nota: <i>here can be specified whose document numbering is used (e.g.: Client, Supplier, ..)</i> (XPath: KnitClothOrder/KCCObody/KCCOitem/garTecSheet/ garConsumptionSet/yarnCode/color/@numberingOrg) [Optional] - nota: <i>this attribute should be used either single or coupled with “listName” and “listVersion”</i> (XPath: KnitClothOrder/KCCObody/KCCOitem/appMnfrOperation/ note/@numberingOrg) [Optional] (XPath: KnitClothOrder/KCCObody/KCCOitem/apparelComponent/ acsComponent/note/@numberingOrg) [Optional] (XPath: KnitClothOrder/KCCObody/KCCOitem/garTecSheet/ garConsumptionSet/yarnCode/art/@numberingOrg) [Optional] - nota: <i>this attribute should be used either single or coupled with “listName” and “listVersion”</i> (XPath: KnitClothOrder/KCCOheader/subContractor/id/@numberingOrg) [Optional] (XPath: KnitClothOrder/KCCObody/KCCOitem/apparelProd/ garmentPartCode/@numberingOrg) [Optional] (XPath: KnitClothOrder/KCCObody/KCCOitem/apparelComponent/ garmentPartComponent/refDoc/docID/@numberingOrg) [Optional] - nota: <i>here can be specified whose document numbering is used (e.g.: Client, Supplier, ..)</i> (XPath: KnitClothOrder/KCCOheader/buyer/id/@numberingOrg) [Optional] (XPath: KnitClothOrder/KCCObody/KCCOitem/apparelProd/ garmentPartCode/fabric/@numberingOrg) [Optional] - nota: <i>this attribute should be used either single or coupled with “listName” and “listVersion”</i> (XPath: KnitClothOrder/KCCObody/KCCOitem/apparelComponent/ garmentPartComponent/dyeN/@numberingOrg) [Optional] (XPath: KnitClothOrder/KCCObody/KCCOitem/apparelProd/ garmentPartCode/mod/@numberingOrg) [Optional] - nota: <i>this attribute should be ALTERNATIVE to the others</i> (XPath: KnitClothOrder/KCCObody/KCCOitem/apparelComponent/ garmentPartComponent/note/@numberingOrg) [Optional] (XPath: KnitClothOrder/KCCObody/KCCOitem/garTecSheet/ garConsumptionSet/texCode/pattern/@numberingOrg) [Optional] - nota: <i>this attribute should be used either single or coupled with “listName” and “listVersion”</i> (XPath: KnitClothOrder/KCCObody/KCCOitem/apparelComponent/ acsComponent/acsCode/pattern/@numberingOrg) [Optional] - nota: <i>this attribute should be used either single or coupled with “listName” and “listVersion”</i> (XPath: KnitClothOrder/KCCObody/KCCOitem/apparelComponent/ acsComponent/acsCode/color/@numberingOrg) [Optional] - nota: <i>this attribute should be used either single or coupled with “listName” and “listVersion”</i> (XPath: KnitClothOrder/KCCObody/KCCOitem/garTecSheet/ garConsumptionSet/garConsumption/@numberingOrg) [Optional] (XPath: KnitClothOrder/KCCObody/KCCOitem/apparelComponent/ acsComponent/acsCode/@numberingOrg) [Optional] (XPath: KnitClothOrder/KCCObody/KCCOitem/apparelComponent/ acsComponent/acsCode/art/@numberingOrg) [Optional] - nota: <i>this attribute should be used either single or coupled with “listName” and “listVersion”</i> (XPath: KnitClothOrder/KCCObody/KCCOitem/garTecSheet/ garmentCode/garmentCodeB/mod/@numberingOrg) [Optional] - nota: <i>this attribute should be ALTERNATIVE to the others</i> (XPath: KnitClothOrder/KCCObody/KCCOitem/garTecSheet/ garSizeSet/@numberingOrg) [Optional]</p>
--	---

(XPath: KnitClothOrder/KCCObody/KCCOitem/apparelComponent/yarnComponent/yarnCode/@numberingOrg) [Optional] [Default= CL]

(XPath: KnitClothOrder/KCCObody/KCCOitem/apparelComponent/fabricComponent/texCode/art/@numberingOrg) [Optional]

- nota: *this attribute should be used either single or coupled with "listName" and "listVersion"*

(XPath: KnitClothOrder/KCCObody/KCCOitem/garTecSheet/garmentCode/garmentCodeB/color/@numberingOrg) [Optional]

- nota: *this attribute should be used either single or coupled with "listName" and "listVersion"*

(XPath: KnitClothOrder/KCCObody/KCCOitem/garTecSheet/garmentCode/garmentCodeB/fabric/@numberingOrg) [Optional]

- nota: *this attribute should be used either single or coupled with "listName" and "listVersion"*

(XPath: KnitClothOrder/KCCObody/KCCOitem/garTecSheet/garConsumptionSet/texCode/@numberingOrg) [Optional]

(XPath: KnitClothOrder/KCCObody/KCCOitem/garTecSheet/garmentCode/garmentCodeB/@numberingOrg) [Optional]

(XPath: KnitClothOrder/KCCObody/KCCOitem/garTecSheet/garmentCode/@numberingOrg) [Optional]

(XPath: KnitClothOrder/KCCObody/KCCOitem/apparelComponent/yarnComponent/note/@numberingOrg) [Optional]

(XPath: KnitClothOrder/KCCObody/KCCOitem/garTecSheet/garConsumptionSet/texCode/art/@numberingOrg) [Optional]

- nota: *this attribute should be used either single or coupled with "listName" and "listVersion"*

(XPath: KnitClothOrder/KCCOheader/docID/@numberingOrg) [Optional]

- nota: *here can be specified whose document numbering is used (e.g.: Client, Supplier, ..)*

(XPath: KnitClothOrder/KCCObody/KCCOitem/apparelComponent/yarnComponent/yarnCode/art/@numberingOrg) [Optional]

- nota: *this attribute should be used either single or coupled with "listName" and "listVersion"*

(XPath: KnitClothOrder/KCCObody/KCCOitem/apparelComponent/fabricComponent/texCode/@numberingOrg) [Optional]

(XPath: KnitClothOrder/KCCObody/KCCOitem/apparelComponent/yarnComponent/yarnCode/color/@numberingOrg) [Optional]

- nota: *this attribute should be used either single or coupled with "listName" and "listVersion"*

(XPath: KnitClothOrder/KCCObody/KCCOitem/apparelComponent/yarnComponent/dyeN/@numberingOrg) [Optional]

(XPath: KnitClothOrder/KCCObody/KCCOitem/garTecSheet/garmentCode/garmentCodeA/art/@numberingOrg) [Optional]

- nota: *this attribute should be used either single or coupled with "listName" and "listVersion"*

(XPath: KnitClothOrder/KCCObody/KCCOitem/garTecSheet/garConsumptionSet/acsCode/pattern/@numberingOrg) [Optional]

- nota: *this attribute should be used either single or coupled with "listName" and "listVersion"*

(XPath: KnitClothOrder/KCCObody/KCCOitem/apparelComponent/fabricComponent/texCode/pattern/@numberingOrg) [Optional]

- nota: *this attribute should be used either single or coupled with "listName" and "listVersion"*

(XPath: KnitClothOrder/KCCObody/KCCOitem/garTecSheet/garConsumptionSet/acsCode/art/@numberingOrg) [Optional]

- nota: *this attribute should be used either single or coupled with "listName" and "listVersion"*

(XPath: KnitClothOrder/KCCObody/KCCOitem/garTecSheet/refDoc/docID/@numberingOrg) [Optional]

- nota: *here can be specified whose document numbering is used (e.g.: Client, Supplier, ..)*

(XPath: KnitClothOrder/KCCObody/KCCOitem/garTecSheet/garmentCode/garmentCodeB/artGroup/@numberingOrg) [Optional]

	<p>- nota: <i>this attribute should be used either single or coupled with "listName" and "listVersion"</i> (XPath: KnitClothOrder/KCCObody/KCCOitem/garTecSheet/garConsumptionSet/acsCode/color/@numberingOrg) [Optional]</p> <p>- nota: <i>this attribute should be used either single or coupled with "listName" and "listVersion"</i> (XPath: KnitClothOrder/KCCObody/KCCOitem/garTecSheet/garConsumptionSet/acsCode/@numberingOrg) [Optional]</p> <p>(XPath: KnitClothOrder/KCCObody/KCCOitem/apparelComponent/yarnComponent/refDoc/docID/@numberingOrg) [Optional]</p> <p>- nota: <i>here can be specified whose document numbering is used (e.g.: Client, Supplier, ..)</i> (XPath: KnitClothOrder/KCCOheader/refDoc/docID/@numberingOrg) [Optional]</p> <p>- nota: <i>here can be specified whose document numbering is used (e.g.: Client, Supplier, ..)</i> (XPath: KnitClothOrder/KCCObody/KCCOitem/apparelComponent/yarnComponent/lotN/@numberingOrg) [Optional]</p>
@part	<p>percent fraction of a total payment</p> <p>- base type: decimal, min inclusive: 1, max inclusive: 99, fraction digits: 2, (XPath: KnitClothOrder/terms/insPayment/@part) [Required]</p> <p>- nota: <i>here the % value of each installment must be indicated</i></p>
pattern	<p>pattern/design number of the product, when not included in the article code</p> <p>- base type: string, max length: 15, (XPath: KnitClothOrder/KCCObody/KCCOitem/garTecSheet/garConsumptionSet/acsCode/pattern) 0-1 (XPath: KnitClothOrder/KCCObody/KCCOitem/apparelComponent/acsComponent/acsCode/pattern) 0-1 (XPath: KnitClothOrder/KCCObody/KCCOitem/apparelComponent/fabricComponent/texCode/pattern) 0-1 (XPath: KnitClothOrder/KCCObody/KCCOitem/garTecSheet/garConsumptionSet/texCode/pattern) 0-1</p>
payMode	<p>way or means of payment</p> <p>- base type: string, cod. table: T2, (XPath: KnitClothOrder/terms/insPayment/payMode) 0-1 (XPath: KnitClothOrder/terms/payment/payMode) 0-1</p>
payTerm	<p>code specifying the terms or time by which the payment must be done</p> <p>- base type: string, cod. table: T1, (XPath: KnitClothOrder/terms/payment/payTerm) 1-1 (XPath: KnitClothOrder/terms/insPayment/payTerm) 1-1</p>
payTermText	<p>free text specifying the terms by which the payment must be done (time/mode or means)</p> <p>- base type: string, max length: 40, (XPath: KnitClothOrder/terms/payment/payTermText) 1-1 (XPath: KnitClothOrder/terms/insPayment/payTermText) 1-1</p>
pcQty	<p>percent quantity of a raw material or of a specified component in a fabric or in a yarn</p> <p>- base type: decimal, min inclusive: 0, max inclusive: 100, fraction digits: 2, (XPath: KnitClothOrder/KCCObody/KCCOitem/apparelComponent/yarnComponent/pcQty) 0-1</p> <p>- note: <i>percentage of the component in the end product</i></p>
percCompos	<p>fiber rate in the product composition</p> <p>- base type: decimal, min inclusive: 0, max inclusive: 100, fraction digits: 2, (XPath: KnitClothOrder/KCCObody/KCCOitem/garTecSheet/fabricCompos/percCompos) 1-9</p>
person	<p>name of the contact person within a Party</p> <p>- base type: string, max length: 40, (XPath: KnitClothOrder/KCCOheader/subContractor/person) 0-1</p>

	<p>(XPath: KnitClothOrder/KCCOheader/buyer/person) 0-1 (XPath: KnitClothOrder/KCCObody/KCCOitem/thirdParty/person) 0-1 (XPath: KnitClothOrder/KCCOheader/thirdParty/person) 0-1</p>
@phone	<p>phone number of the contact person within a Party - base type: string, max length: 35, (XPath: KnitClothOrder/KCCOheader/buyer/person/@phone) [Optional] (XPath: KnitClothOrder/KCCObody/KCCOitem/thirdParty/person/@phone) [Optional] (XPath: KnitClothOrder/KCCOheader/thirdParty/person/@phone) [Optional] (XPath: KnitClothOrder/KCCOheader/subContractor/person/@phone) [Optional]</p>
postCode	<p>code defining the postal zone - base type: string, max length: 10, (XPath: KnitClothOrder/KCCOheader/thirdParty/postCode) 0-1 (XPath: KnitClothOrder/KCCOheader/subContractor/postCode) 0-1 (XPath: KnitClothOrder/KCCOheader/buyer/postCode) 0-1 (XPath: KnitClothOrder/KCCObody/KCCOitem/thirdParty/postCode) 0-1</p>
price	<p>unit price of the article, object or service specified - base type: decimal, min inclusive: 0, fraction digits: 2, (XPath: KnitClothOrder/KCCObody/KCCOitem/price) 0-1</p>
@priceQualifier	<p>type of price with reference to discount and taxes - base type: string, cod. table: NT20, (XPath: KnitClothOrder/KCCObody/KCCOitem/price/@priceQualifier) [Optional] [Default= NET]</p>
@productLevel	<p>level of the product (end or intermediate) yielded by an operation in a work cycle - base type: string, cod. table: NT22, (XPath: KnitClothOrder/KCCObody/KCCOitem/@productLevel) [Optional] [Default= END] - nota: <i>the qualifier "intermediate" must be used when the product is also a component in an other line of the same Commission Order</i></p>
qty	<p>net quantity of the article or object correlated, qualified by the function of the document (ordering, delivering, ..) and by the context - base type: decimal, min inclusive: 0, fraction digits: 2, (XPath: KnitClothOrder/KCCObody/KCCOitem/progress/qty) 1-2 (XPath: KnitClothOrder/KCCObody/KCCOitem/apparelComponent/acsComponent/qty) 1-2 (XPath: KnitClothOrder/KCCObody/KCCOitem/apparelComponent/fabricComponent/qty) 1-3 - note: <i>here is the code of the component used in the yarn manufacturing operation</i> (XPath: KnitClothOrder/KCCObody/KCCOitem/apparelProd/csRange/sizeMatrix/sizeRow/qty) 0-1 (XPath: KnitClothOrder/KCCObody/KCCOitem/apparelComponent/garmentPartComponent/qty) 1-2 (XPath: KnitClothOrder/KCCObody/KCCOitem/apparelProd/qty) 1-2 (XPath: KnitClothOrder/KCCObody/KCCOitem/apparelComponent/yarnComponent/qty) 1-2 - note: <i>quantity to be consumed in the manufacturing operation</i> (XPath: KnitClothOrder/KCCObody/KCCOitem/garTecSheet/garConsumptionSet/garConsumption/qty) 1-1 - note: <i>here is the provisional consumption</i></p>
qtyVariance	<p>difference between two quantities qualified by the context (e.g.: delivered vs. ordered; received vs. despatched etc..) - base type: decimal, fraction digits: 2, (XPath: KnitClothOrder/KCCObody/KCCOitem/garTecSheet/garConsumptionSet/garConsumption/qtyVariance) 0-1 - note: <i>here is the difference between provisional and effective consumption</i></p>
@role	<p>Third Party role qualifier - base type: string, cod. table: NT2,</p>

	<p>(XPath: KnitClothOrder/KCCOheader/thirdParty/@role) [Required] (XPath: KnitClothOrder/KCCObody/KCCOitem/thirdParty/@role) [Required]</p>
season	<p>sale season; defined as: season (1 crt) + year (4 crt) - season: S/S=1 A/W=2 Spring=3 Summer=4 Autumn=5 Winter=6: for more than four seasons use alphabetic sequence: 1st season=A 2nd season=B etc.etc.</p> <ul style="list-style-type: none"> - base type: string, max length: 15, (XPath: KnitClothOrder/KCCObody/KCCOitem/apparelComponent/yarnComponent/refDoc/season) 0-1 - note: here indicates the season to which the referenced document belongs (XPath: KnitClothOrder/KCCObody/KCCOitem/appMnfrOperation/refDoc/season) 0-1 - note: here indicates the season to which the referenced document belongs (XPath: KnitClothOrder/KCCObody/KCCOitem/apparelComponent/acsComponent/refDoc/season) 0-1 - note: here indicates the season to which the referenced document belongs (XPath: KnitClothOrder/KCCObody/KCCOitem/apparelComponent/fabricComponent/refDoc/season) 0-1 - note: here indicates the season to which the referenced document belongs (XPath: KnitClothOrder/KCCObody/KCCOitem/garTecSheet/refDoc/season) 0-1 - note: here indicates the season to which the referenced document belongs (XPath: KnitClothOrder/KCCObody/KCCOitem/apparelComponent/garmentPartComponent/refDoc/season) 0-1 - note: here indicates the season to which the referenced document belongs (XPath: KnitClothOrder/KCCOheader/refDoc/season) 0-1 - note: here indicates the season to which the referenced document belongs (XPath: KnitClothOrder/KCCOheader/season) 0-1
@sender	<p>qualifier that specifies the Party issuing of the document</p> <ul style="list-style-type: none"> - base type: boolean, (XPath: KnitClothOrder/KCCObody/KCCOitem/thirdParty/@sender) [Optional] - nota: This attribute is mandatory when the STYLESHEET must be produced (XPath: KnitClothOrder/KCCOheader/subContractor/@sender) [Optional] - nota: This attribute is mandatory when the STYLESHEET must be produced (XPath: KnitClothOrder/KCCOheader/thirdParty/@sender) [Optional] - nota: This attribute is mandatory when the STYLESHEET must be produced (XPath: KnitClothOrder/KCCOheader/buyer/@sender) [Optional] - nota: This attribute is mandatory when the STYLESHEET must be produced
serialN	<p>serial number used for the identification of a physical unit</p> <ul style="list-style-type: none"> - base type: string, max length: 15, (XPath: KnitClothOrder/KCCObody/KCCOitem/apparelComponent/fabricComponent/serialN) 0-99 - note: it may be used to identify the pieces/chains that the Subcontractor must use for the commissioned work
size	<p>size number of a garment product (kintwear/clothing)</p> <ul style="list-style-type: none"> - base type: string, max length: 15, (XPath: KnitClothOrder/KCCObody/KCCOitem/apparelProd/garmentPartCode/size) 0-1 (XPath: KnitClothOrder/KCCObody/KCCOitem/garTecSheet/garMeaSet/garMea/size) 1-1 (XPath: KnitClothOrder/KCCObody/KCCOitem/apparelProd/garmentCode/garmentCodeB/size) 0-1 (XPath: KnitClothOrder/KCCObody/KCCOitem/garTecSheet/garmentCode/garmentCodeB/size) 0-1 (XPath: KnitClothOrder/KCCObody/KCCOitem/apparelComponent/garmentPartComponent/garmentPartCode/size) 0-1 (XPath: KnitClothOrder/KCCObody/KCCOitem/apparelProd/

	csRange/sizeMatrix/sizeRow/size) 1-1
sizeEnd	first size of a range of sizes - base type: string, max length: 15, (XPath: KnitClothOrder/KCCObody/KCCOitem/garTecSheet/ garSizeSet/garSizeTier/sizeEnd) 0-1
sizeStart	first size of a range of sizes - base type: string, max length: 15, (XPath: KnitClothOrder/KCCObody/KCCOitem/garTecSheet/ garSizeSet/garSizeTier/sizeStart) 1-1
@sizeSystemBase	base of the size system - base type: string, cod. table: T423, (XPath: KnitClothOrder/KCCObody/KCCOitem/apparelProd/ csRange/@sizeSystemBase) [Optional]
@sizeSystemNat	nation or agency identifying the size system - base type: string, cod. table: T421, (XPath: KnitClothOrder/KCCObody/KCCOitem/apparelProd/ csRange/@sizeSystemNat) [Optional]
@sizeSystemSeg	market segment identifying the size system - base type: string, cod. table: T422, (XPath: KnitClothOrder/KCCObody/KCCOitem/apparelProd/ csRange/@sizeSystemSeg) [Optional]
specValue	value requested for a characteristics or a parameter that can be measured - base type: decimal, (XPath: KnitClothOrder/KCCObody/KCCOitem/garTecSheet/ garMeaSet/garMea/specValue) 1-1
street	street and building number identifying a location - base type: string, max length: 80, (XPath: KnitClothOrder/KCCObody/KCCOitem/thirdParty/street) 0-1 (XPath: KnitClothOrder/KCCOheader/buyer/street) 0-1 (XPath: KnitClothOrder/KCCOheader/subContractor/street) 0-1 (XPath: KnitClothOrder/KCCOheader/thirdParty/street) 0-1
subCountry	short name or code of the sub-country entity - base type: string, max length: 9, (XPath: KnitClothOrder/KCCOheader/thirdParty/subCountry) 0-1 (XPath: KnitClothOrder/KCCObody/KCCOitem/thirdParty/subCountry) 0-1 (XPath: KnitClothOrder/KCCOheader/buyer/subCountry) 0-1 (XPath: KnitClothOrder/KCCOheader/subContractor/subCountry) 0-1
@subject	qualifier of the matter treated - base type: string, cod. table: NT40, (XPath: KnitClothOrder/KCCObody/KCCOitem/garTecSheet/image/@subject) [Optional] (XPath: KnitClothOrder/KCCObody/KCCOitem/garTecSheet/ mnfrNote/@subject) [Optional]
transCondition	special condition of transport or special service requested to the Forwarder - base type: string, cod. table: T38, (XPath: KnitClothOrder/terms/transInfo/transCondition) 0-3
transConditionText	free text description of the special condition of transport or special service requested to the Forwarder - base type: string, max length: 100, (XPath: KnitClothOrder/terms/transInfo/transConditionText) 0-1
transMeans	means of transport, in general or referred to a specific leg - base type: string, cod. table: T40, (XPath: KnitClothOrder/terms/transInfo/transMeans) 0-1
transMode	way of transport, in general or referred to the specified leg

	<p>- base type: string, cod. table: T8, (XPath: KnitClothOrder/terms/transInfo/transMode) 1-1</p>
@transReason	<p>reason for the transport - base type: string, cod. table: NT11, (XPath: KnitClothOrder/terms/transInfo/@transReason) [Optional]</p>
@um	<p>specification of the unit of measure - base type: string, cod. table: NT7, (XPath: KnitClothOrder/KCCObody/KCCOitem/garTecSheet/ garConsumptionSet/garConsumption/qty/@um) [Required] (XPath: KnitClothOrder/KCCObody/KCCOitem/apparelComponent/ yarnComponent/qty/@um) [Required] (XPath: KnitClothOrder/KCCObody/KCCOitem/apparelComponent/ garmentPartComponent/qty/@um) [Required] (XPath: KnitClothOrder/KCCObody/KCCOitem/apparelComponent/ fabricComponent/qty/@um) [Required] (XPath: KnitClothOrder/KCCObody/KCCOitem/price/@um) [Optional] (XPath: KnitClothOrder/KCCObody/KCCOitem/progress/qty/@um) [Required] (XPath: KnitClothOrder/KCCObody/KCCOitem/apparelProd/qty/@um) [Required] (XPath: KnitClothOrder/terms/transInfo/grossWeight/@um) [Required] (XPath: KnitClothOrder/KCCObody/KCCOitem/apparelComponent/ acsComponent/qty/@um) [Required] (XPath: KnitClothOrder/KCCObody/KCCOitem/garTecSheet/ garMeaSet/garMea/specValue/@um) [Optional] (XPath: KnitClothOrder/KCCObody/KCCOitem/garTecSheet/ garConsumptionSet/garConsumption/qtyVariance/@um) [Optional] (XPath: KnitClothOrder/KCCObody/KCCOitem/garTecSheet/ netWeight/@um) [Required] (XPath: KnitClothOrder/KCCObody/KCCOitem/apparelComponent/ yarnComponent/pcQty/@um) [Optional] - nota: <i>to be used when it has to be soecified if the declared percentage is by weight, volume, etc...</i> (XPath: KnitClothOrder/KCCObody/KCCOitem/garTecSheet/ grossWeight/@um) [Required] (XPath: KnitClothOrder/KCCObody/KCCOitem/apparelProd/ csRange/sizeMatrix/sizeRow/qty/@um) [Required] (XPath: KnitClothOrder/terms/transInfo/netWeight/@um) [Required]</p>
@varReason	<p>reason for the difference between the two quantities specified by the context - base type: string, cod. table: T46, (XPath: KnitClothOrder/KCCObody/KCCOitem/garTecSheet/ garConsumptionSet/garConsumption/qtyVariance/@varReason) [Optional]</p>
@VAT	<p>VAT rate or code - base type: string, cod. table: NT16, (XPath: KnitClothOrder/KCCObody/KCCOitem/thirdParty/@VAT) [Optional] (XPath: KnitClothOrder/terms/allowanceCharge/@VAT) [Optional] (XPath: KnitClothOrder/KCCOheader/thirdParty/@VAT) [Optional] (XPath: KnitClothOrder/KCCObody/KCCOitem/lineN/@VAT) [Optional]</p>
warpLetter	<p>letter that indicates a specific yarn in the warping formula (diagram) - base type: string, length: 1, (XPath: KnitClothOrder/KCCObody/KCCOitem/apparelComponent/ yarnComponent/warpLetter) 0-1 - note: <i>to be used only in the Warping order</i></p>
weftLetter	<p>letter that indicates a specific yarn in the wefting formula (diagram) - base type: string, length: 1, (XPath: KnitClothOrder/KCCObody/KCCOitem/apparelComponent/ yarnComponent/weftLetter) 0-1 - note: <i>to be used only in the Weaving order</i></p>

2.3 Enumeration tables

List of enumeration tables used in the XML document. You can find the corresponding codes (only for tables with less than 100 values) in the document `Decoding_Values.pdf`, available at: <http://www.moda-ml.org/moda-ml/repository/guide/v2011-1/>; moreover, all the enumeration tables are available at: <http://www.moda-ml.org/imple/show-codes.asp>.

- NT11 - Transport causal
- NT16 - VAT rate or code
- NT18 - message function
- NT2 - Third party qualifier
- NT20 - price qualifier
- NT22 - product type of an operation
- NT29 - format of a date
- NT3 - Data format
- NT37 - Committed quantity qualifier
- NT40 - manufacturing note qualifiers
- NT41 - garment attributes
- NT6 - Coding system owner/issuer
- NT7 - Unity of measure
- T1 - Terms of payment
- T10 - ISO3166 - Country
- T19 - fibre type
- T2 - Modes of payment
- T205 - type of job in knitting/clothing
- T21 - type of document
- T265 - type of job technology in knitting/clothing
- T275 - type of machine for knitting/clothing
- T3 - Terms of delivery
- T38 - transport conditions
- T40 - type of transport means
- T41 - type of Allowance or Charge
- T421 - size system: nationality
- T422 - size system: market segment
- T423 - size system: base
- T44 - additional code type
- T46 - quantity variance reason
- T48 - garment part type
- T7 - Manufacturing status
- T8 - Modes of Transport
- T9 - ISO4217 - Currency

Annex A

Representative images of the principal complex elements' structure.

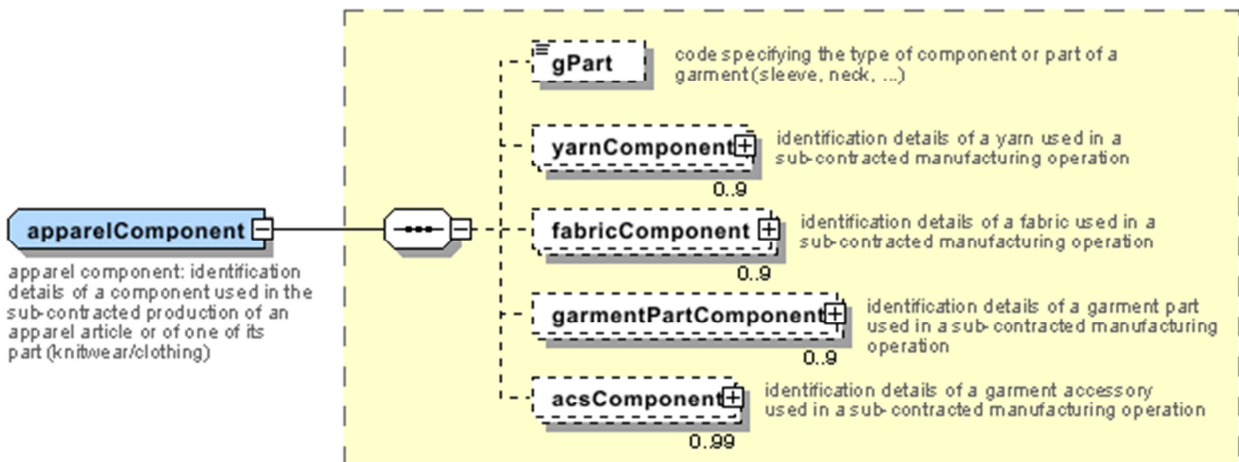
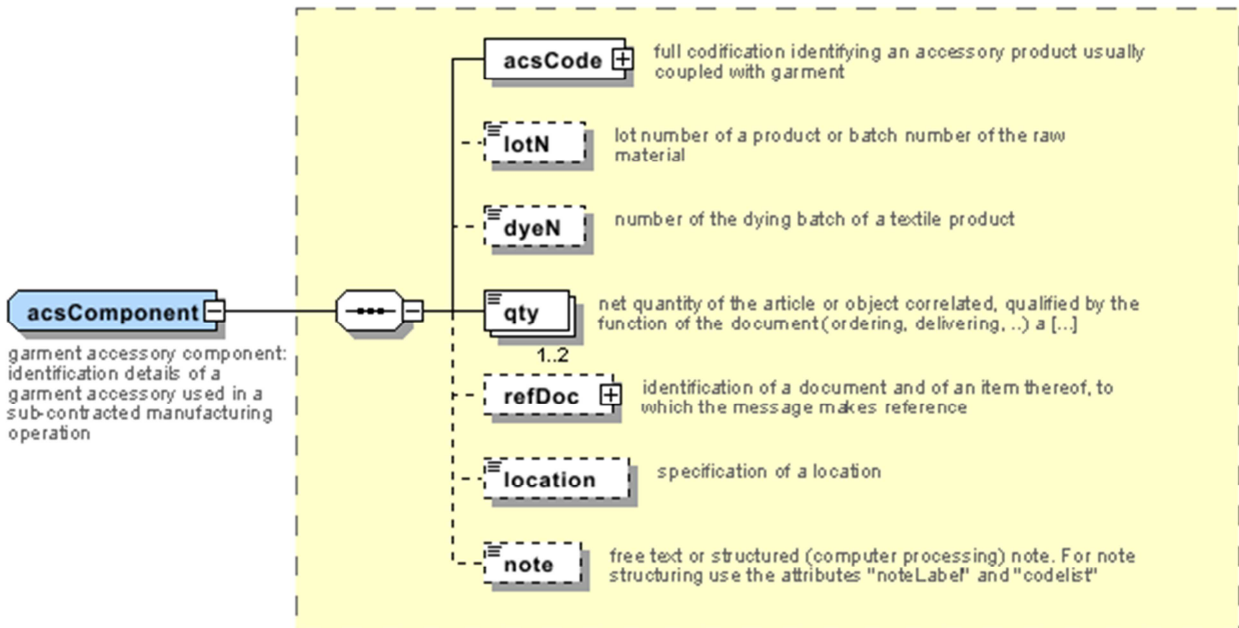

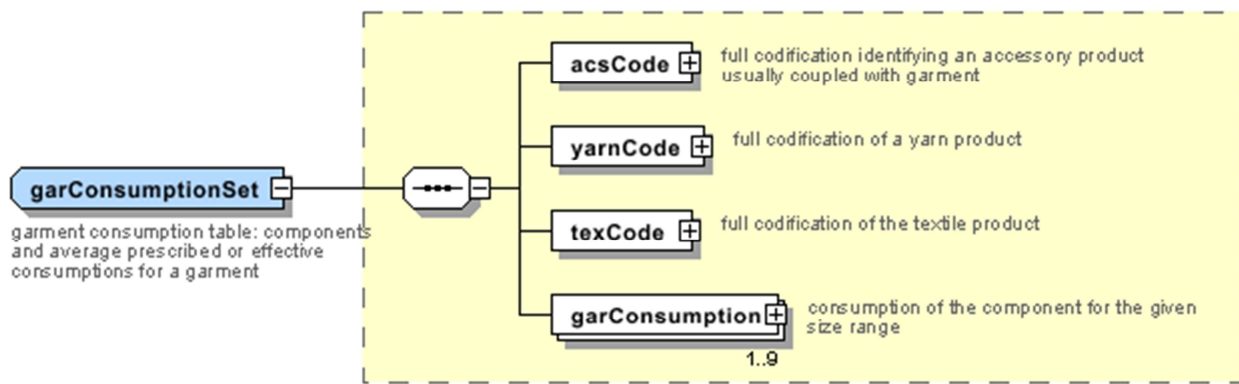
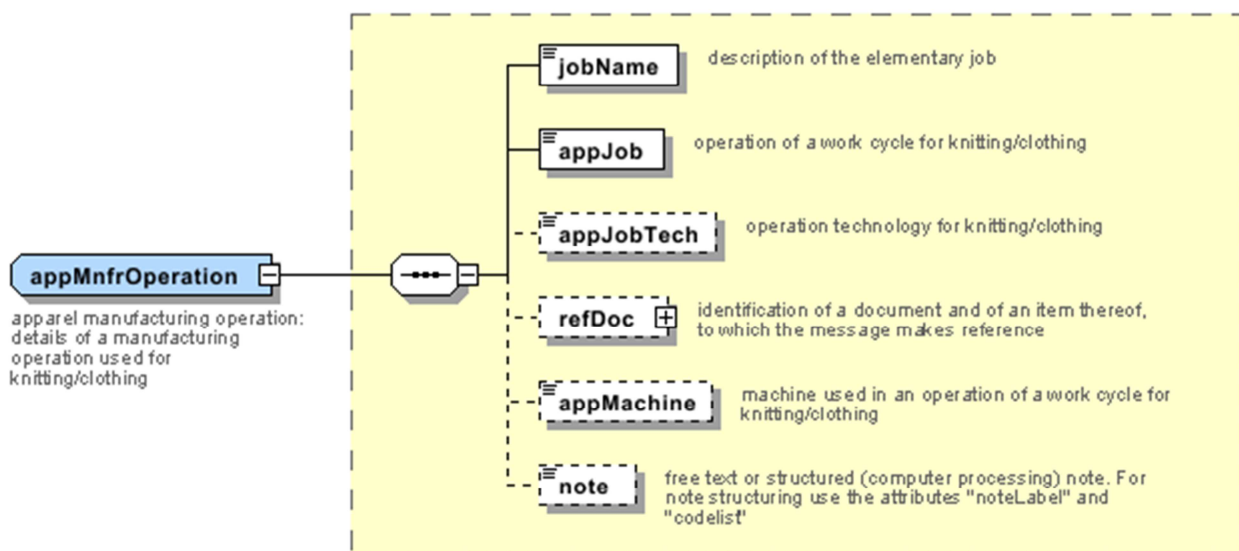
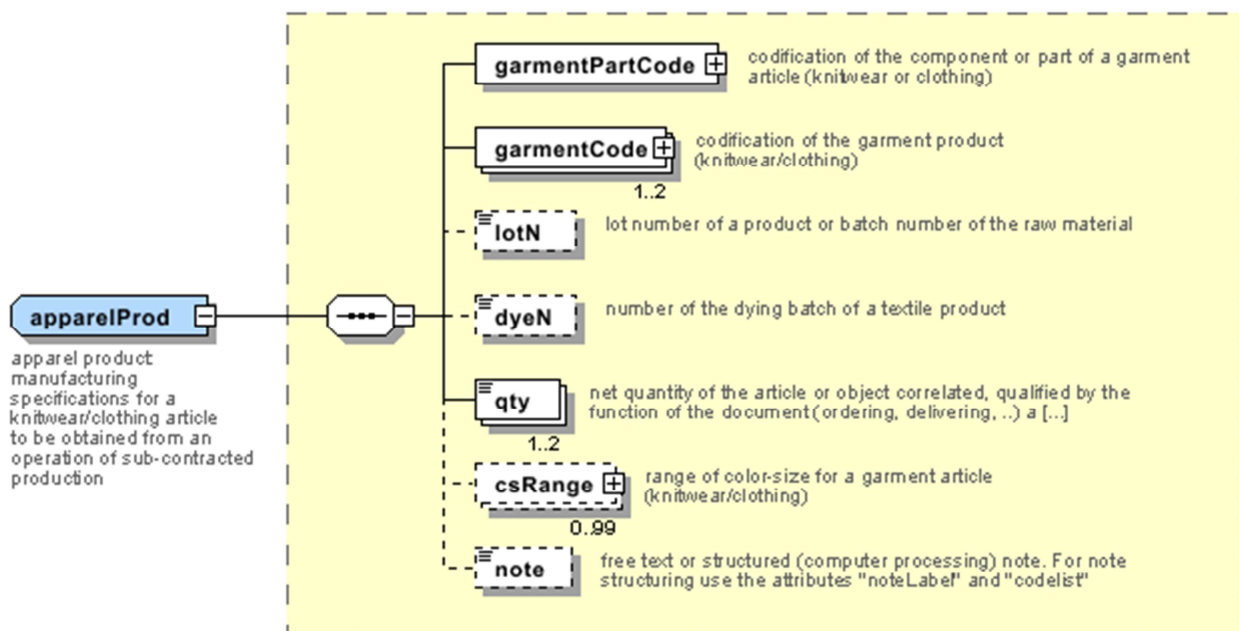

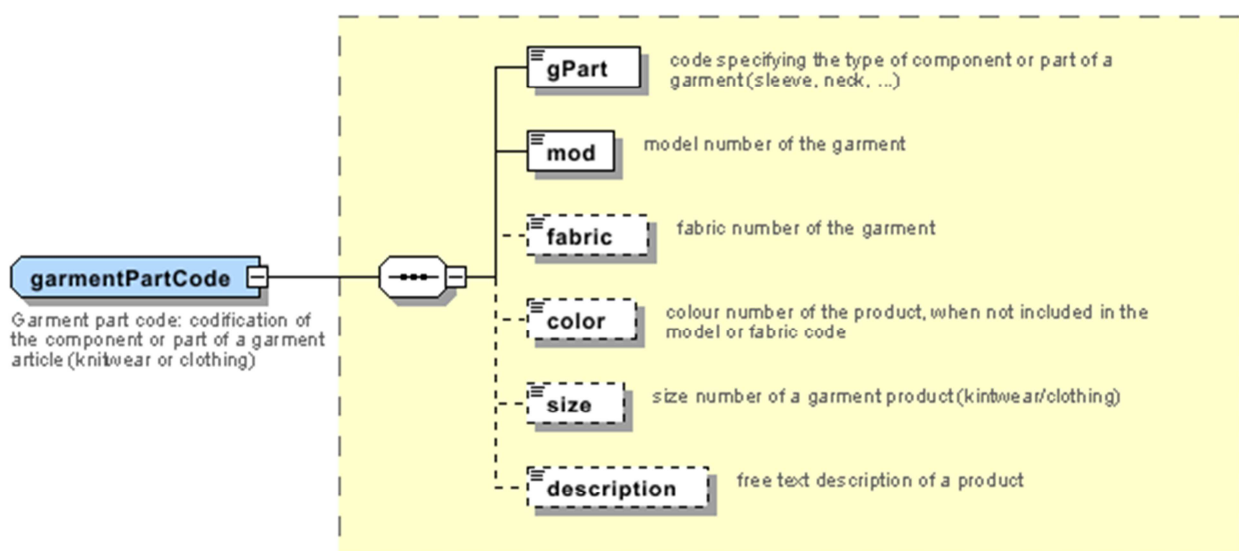
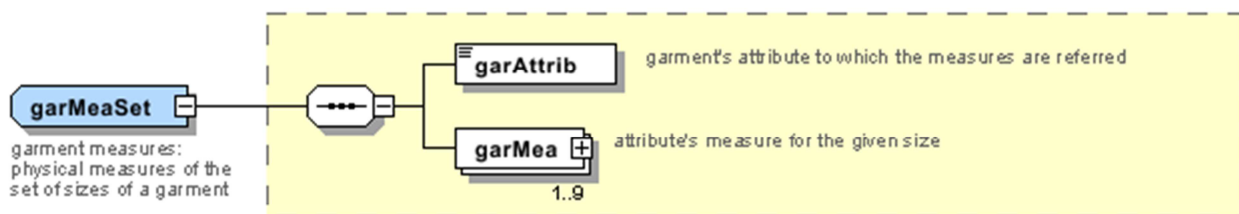
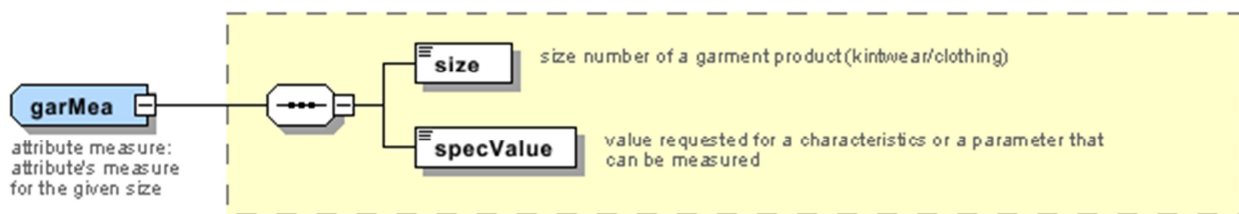

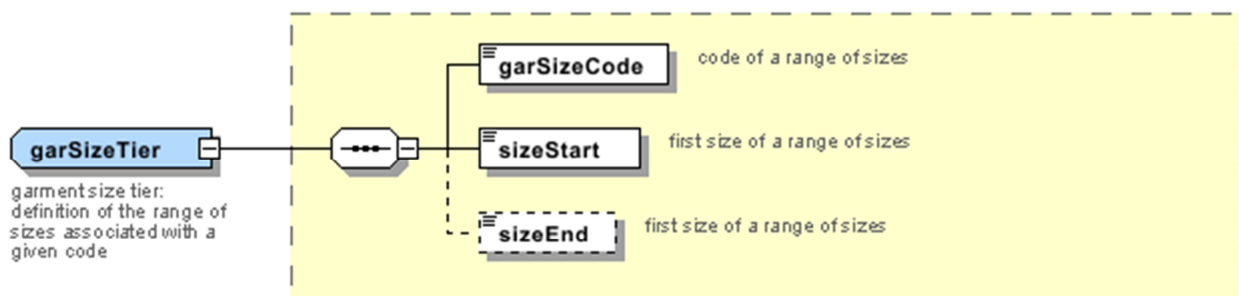
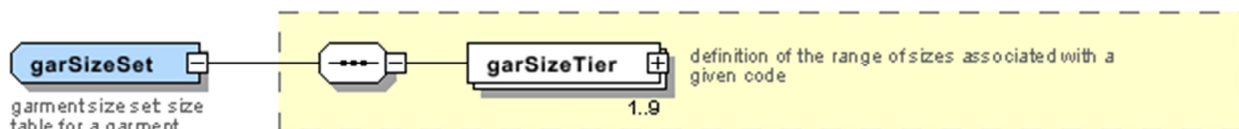
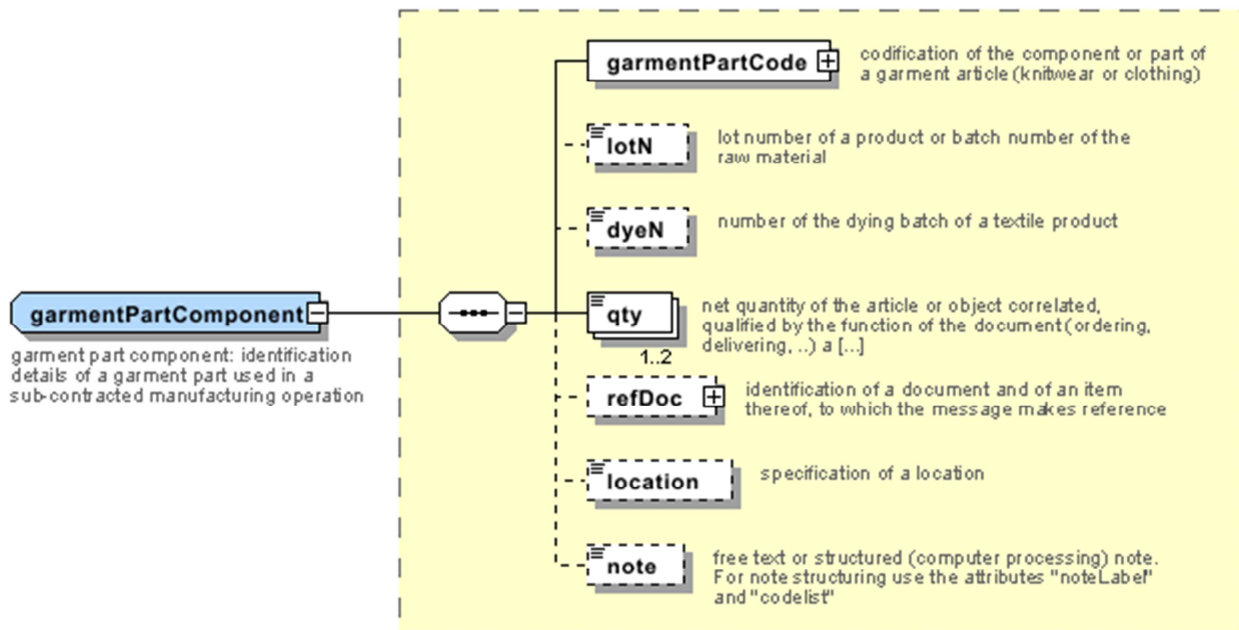

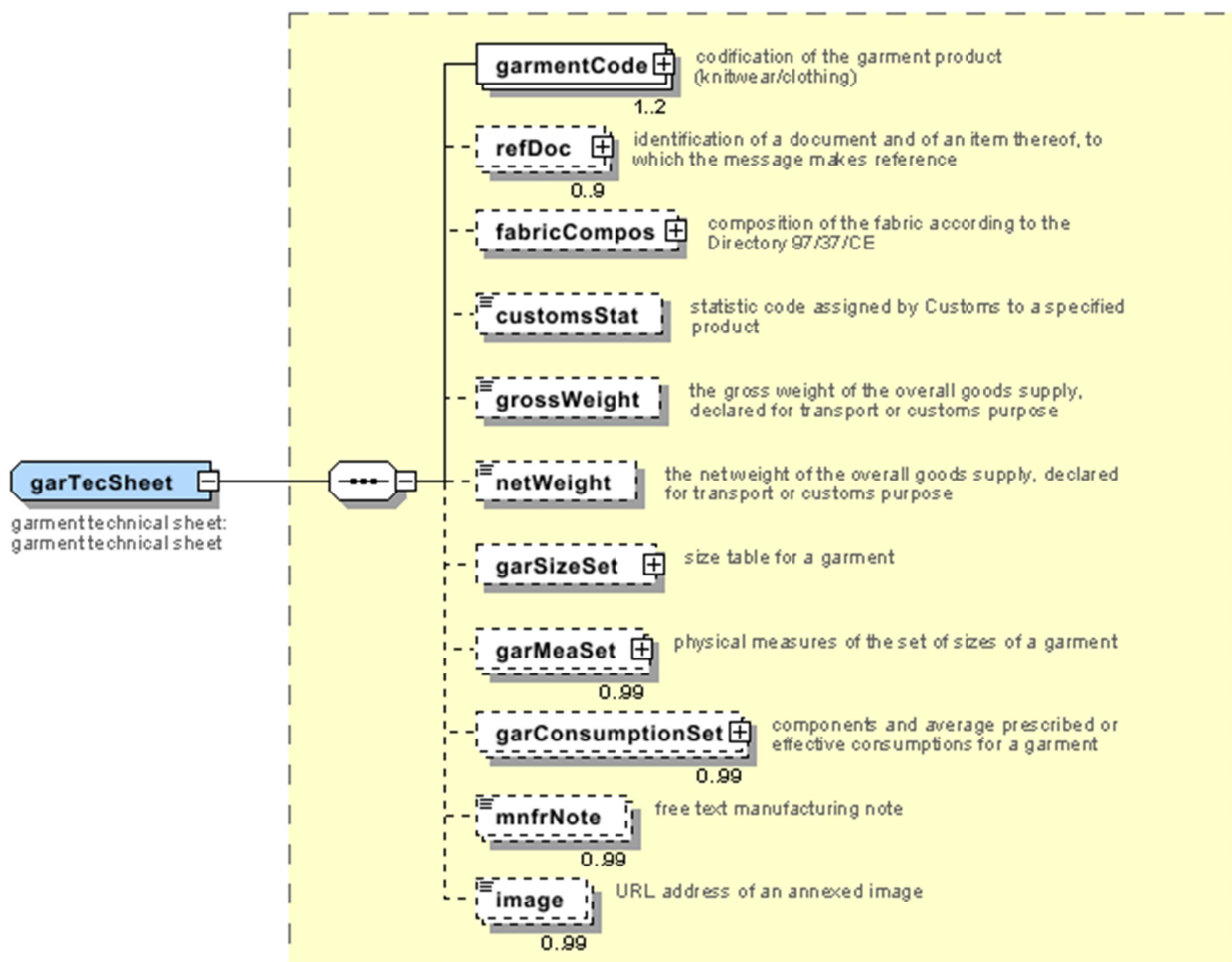

KCCOheader
 KCCO header:
 header of the
 document
 KNITTING/CLOTHING
 COMMISSION
 ORDER

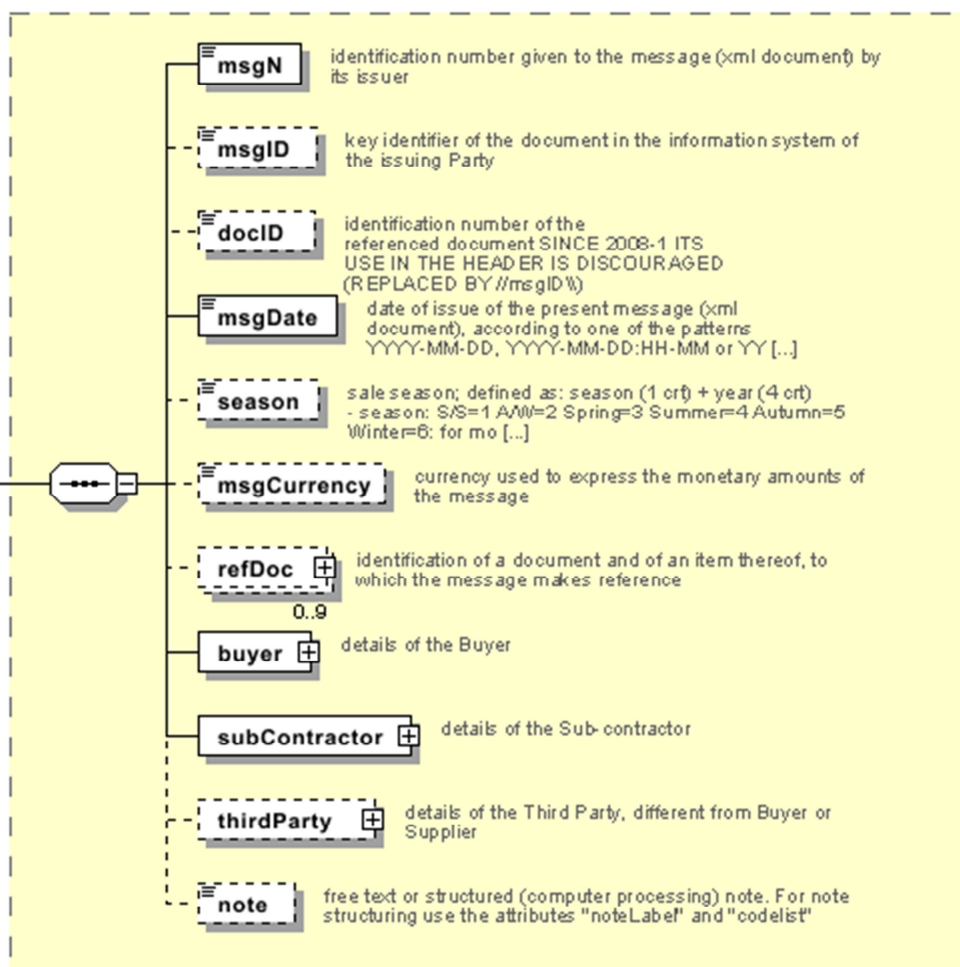

KCCOitem
 KCCO item:
 line of the
 document
 KNITTING/CLOTHING
 COMMISSION
 ORDER

