



<http://www.moda-ml.org>

IMPLEMENTATION GUIDE
TRANSACTION "KNITTING-CLOTHING
COMMISSION ORDER"

Version: 2013-1

Date of release: 18/11/2011

Document code: G040

XML Schema repository:<http://www.moda-ml.org/moda-ml/repository/schema/v2013-1/default.asp>

Guides repository:<http://www.moda-ml.org/moda-ml/repository/guide/v2013-1/default.asp>

Guide filename: G040-MODA-ML-Knitting-clothingCommissionOrder.pdf

1. BUSINESS DESCRIPTION

1.1 Scope

to be defined

1.2 Generalities

The knitting-clothing commissio is used by the Knitwear or Clothing Company to commit to a Sub-contractor the manufacturing of knitwear or clothing articles

Each commission order can include one or more operations of the manufacturing cycle, each one correspondind to a line item

The document can be used either to order the manufacturing of finished goods or of component parts of them.

When the Commissioner orders a sequence of operations to different Sub-contractors, he can use this document also to dispose the delivering of semifinished goods from one Sub-contractor to the next.

This document specifies only the technology (when necessary) and the characteristics of the final product and of the initial goods (components) to be used in the manufacturing

The output product specified in each line item can be the inputcomponent in a following line item also in the same Commission order.

1.3. Possible scenario

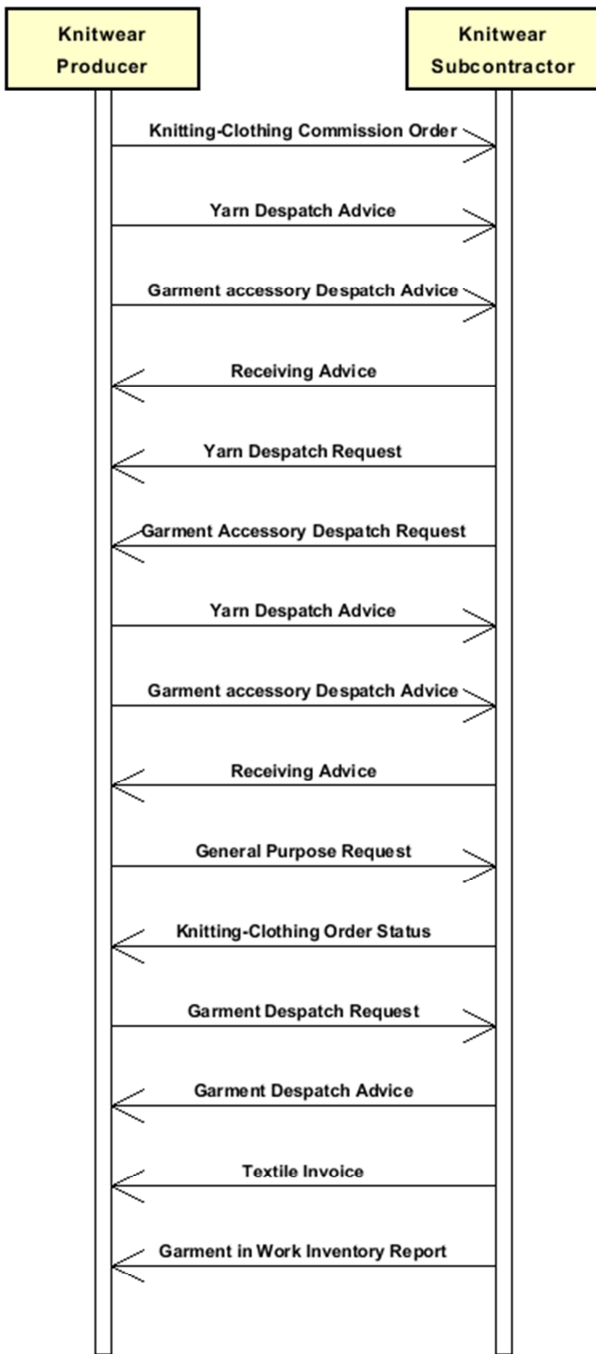

2. IMPLEMENTATION GUIDE

2.1 General structure of XML document

All the business data that can be exchanged through this class of documents are shown in the following "document structure", that provides a simplified vision of the Schema.

In particular:

- the two numbers following each element define its "cardinality" (minimum and maximum number of occurrences); the minimum equal zero indicates that the element is optional, the minimum greater than zero indicates that is mandatory;
- the bold character denotes the complex elements (aggregates of simple elements) that were built for the sake of functionality and re-usability of some complex informations sets. The child elements in each parent element are easily spotted as "indented";
- the symbol "@" denotes an attribute of the preceding element; here "the usage indicator (optional, required, ...)" is shown in square brackets.

Structure

KnitClothOrder

@msgfunction [Optional] [Default= OR]

@version [Optional] [Default= 2013-1]

@useProfile [Optional]

| **KCCOheader 1-1**

| | msgN 1-1

| | - choose -

| | msgID 0-1

| | - or -

| | docID 0-1

| | *@numberingOrg [Optional]*

| | - end choose -

| | msgDate 1-1

| | *@dateForm [Optional]*

| | season 0-1

| | msgCurrency 0-1

| | **refDoc 0-9**

| | *@docType [Required]*

| | | docID 1-2

| | | *@numberingOrg [Optional]*

| | | docDate 0-1

| | | *@dateForm [Optional]*

| | | season 0-1

| | | itemID 0-1

| | **buyer 1-1**

| | *@logo [Optional]*

| | *@sender [Optional]*

| | | id 1-1

| | | *@numberingOrg [Optional]*

| | | legalName 0-1

| | | dept 0-1

| | | person 0-1

| | | *@email [Optional]*

| | | *@phone [Optional]*

| | | *@fax [Optional]*

| | | street 0-1

| | | city 0-1

| | | subCountry 0-1

| | | country 0-1

- | | postCode 0-1
- | | **subContractor 1-1**
- | | @sender [Optional]
- | | id 1-1
- | | @numberingOrg [Optional]
- | | legalName 0-1
- | | dept 0-1
- | | person 0-1
- | | @email [Optional]
- | | @phone [Optional]
- | | @fax [Optional]
- | | street 0-1
- | | city 0-1
- | | subCountry 0-1
- | | country 0-1
- | | postCode 0-1
- | | **thirdParty 0-1**
- | | @VAT [Optional]
- | | @role [Required]
- | | @sender [Optional]
- | | id 1-1
- | | @numberingOrg [Optional]
- | | legalName 0-1
- | | dept 0-1
- | | person 0-1
- | | @email [Optional]
- | | @phone [Optional]
- | | @fax [Optional]
- | | street 0-1
- | | city 0-1
- | | subCountry 0-1
- | | country 0-1
- | | postCode 0-1
- | | note 0-19
- | | @numberingOrg [Optional]
- | | @codeList [Optional]
- | | @noteLabel [Optional]

| **terms 0-1**

- | | **payment 0-5**
- | | @finDiscount [Optional]
- | | @finSurcharge [Optional]
- | | - choose -
- | | | payTerm 1-1
- | | - or -
- | | | payTermText 1-1
- | | - end choose -
- | | | payMode 0-1
- | | **insPayment 0-5**
- | | @part [Required]
- | | - choose -
- | | | payTerm 1-1
- | | - or -
- | | | payTermText 1-1
- | | - end choose -
- | | | payMode 0-1
- | | **trade 0-1**
- | | - choose -
- | | | incoTermText 1-1
- | | - or -
- | | | incoTerm 1-1

- end choose -
- | location 0-1
- | @LRI [Optional]
- transInfo 0-1**
- | @transReason [Optional]
- | transMode 1-1
- | carrier 0-1
- | deliveryPlace 0-1
- | grossWeight 0-1
- | @um [Required]
- | netWeight 0-1
- | @um [Required]
- | transMeans 0-1
- | transCondition 0-3
- | transConditionText 0-1
- allowanceCharge 0-9**
- | @VAT [Optional]
- choose -
- | AC_category 1-1
- or -
- | AC_categoryText 1-1
- choose -
- | AC_percent 1-1
- or -
- | AC_amount 1-1
- end choose -
- | **dtScheme 0-1**
- | @taxType [Required]
- | taxCategory 0-1
- | taxRate 0-1
- | legalRef 0-1
- | @codeList [Required]
- | note 0-19
- | @numberingOrg [Optional]
- | @codeList [Optional]
- | @noteLabel [Optional]

- KCCObody 1-1**
- | **KCCOitem 1-unbounded**
- | @productLevel [Optional] [Default= END]
- | lineN 1-1
- | @VAT [Optional]
- | **apparelProd 1-1**
- choose -
- | **garmentPartCode 1-1**
- | @numberingOrg [Optional]
- | gPart 1-1
- | mod 1-1
- | @numberingOrg [Optional]
- | @codeList [Optional]
- | @listName [Optional]
- | @listVersion [Optional]
- | fabric 0-1
- | @numberingOrg [Optional]
- | @codeList [Optional]
- | @listName [Optional]
- | @listVersion [Optional]
- | color 0-1
- | @numberingOrg [Optional]
- | @codeList [Optional]
- | @listName [Optional]

```

| | | | @listVersion [Optional]
| | | | size 0-1
| | | | @codeList [Optional]
| | | | description 0-1
- or -
| | | | garmentCode 1-2
| | | | @numberingOrg [Optional]
- choose -
| | | | garmentCodeB 1-1
| | | | @numberingOrg [Optional]
| | | | mod 1-1
| | | | @numberingOrg [Optional]
| | | | @codeList [Optional]
| | | | @listName [Optional]
| | | | @listVersion [Optional]
| | | | fabric 0-1
| | | | @numberingOrg [Optional]
| | | | @codeList [Optional]
| | | | @listName [Optional]
| | | | @listVersion [Optional]
| | | | color 0-1
| | | | @numberingOrg [Optional]
| | | | @codeList [Optional]
| | | | @listName [Optional]
| | | | @listVersion [Optional]
| | | | size 0-1
| | | | @codeList [Optional]
| | | | artGroup 0-1
| | | | @numberingOrg [Optional]
| | | | @codeList [Optional]
| | | | @listName [Optional]
| | | | @listVersion [Optional]
| | | | added 0-9
| | | | @numberingOrg [Optional]
| | | | @addType [Optional]
| | | | description 0-1
- or -
| | | | garmentCodeA 1-1
| | | | art 1-1
| | | | @numberingOrg [Optional]
| | | | @codeList [Optional]
| | | | @listName [Optional]
| | | | @listVersion [Optional]
| | | | description 0-1
- end choose -
- end choose -
| | | | lotN 0-1
| | | | @numberingOrg [Optional]
| | | | dyeN 0-1
| | | | @numberingOrg [Optional]
| | | | qty 1-2
| | | | @um [Required]
| | | | csRange 0-99
| | | | @numberingOrg [Optional]
| | | | @sizeSystemNat [Optional]
| | | | @sizeSystemSeg [Optional]
| | | | @sizeSystemBase [Optional]
| | | | color 0-1
| | | | @numberingOrg [Optional]
| | | | @codeList [Optional]
| | | | @listName [Optional]

```

```

| | | | @listVersion [Optional]
| | | | sizeMatrix 1-1
| | | | | sizeRow 1-99
| | | | | drop 0-1
| | | | | @codeList [Optional]
| | | | | size 1-1
| | | | | @codeList [Optional]
| | | | | qty 0-1
| | | | | @um [Required]
| | | | note 0-19
| | | | @numberingOrg [Optional]
| | | | @codeList [Optional]
| | | | @noteLabel [Optional]
| | | price 0-1
| | | @um [Optional]
| | | @priceQualifier [Optional] [Default= NET]
| | | deliveryDate 0-1
| | | @dateForm [Optional]
| | | thirdParty 0-5
| | | @VAT [Optional]
| | | @role [Required]
| | | @sender [Optional]
| | | | id 1-1
| | | | @numberingOrg [Optional]
| | | | legalName 0-1
| | | | dept 0-1
| | | | person 0-1
| | | | @email [Optional]
| | | | @phone [Optional]
| | | | @fax [Optional]
| | | | street 0-1
| | | | city 0-1
| | | | subCountry 0-1
| | | | country 0-1
| | | | postCode 0-1
| | | garTecSheet 0-1
| | | | garmentCode 1-2
| | | | @numberingOrg [Optional]
| | | - choose -
| | | | garmentCodeB 1-1
| | | | @numberingOrg [Optional]
| | | | | mod 1-1
| | | | | @numberingOrg [Optional]
| | | | | @codeList [Optional]
| | | | | @listName [Optional]
| | | | | @listVersion [Optional]
| | | | | fabric 0-1
| | | | | @numberingOrg [Optional]
| | | | | @codeList [Optional]
| | | | | @listName [Optional]
| | | | | @listVersion [Optional]
| | | | | color 0-1
| | | | | @numberingOrg [Optional]
| | | | | @codeList [Optional]
| | | | | @listName [Optional]
| | | | | @listVersion [Optional]
| | | | | size 0-1
| | | | | @codeList [Optional]
| | | | | artGroup 0-1
| | | | | @numberingOrg [Optional]
| | | | | @codeList [Optional]

```



```

| | | | | @listName [Optional]
| | | | | @listVersion [Optional]
| | | | | added 0-9
| | | | | @numberingOrg [Optional]
| | | | | @addType [Optional]
| | | | | description 0-1
- or -
| | | | | garmentCodeA 1-1
| | | | | | art 1-1
| | | | | | | @numberingOrg [Optional]
| | | | | | | @codeList [Optional]
| | | | | | | @listName [Optional]
| | | | | | | @listVersion [Optional]
| | | | | | description 0-1
- end choose -
| | | | | refDoc 0-9
| | | | | | @docType [Required]
| | | | | | | docID 1-2
| | | | | | | | @numberingOrg [Optional]
| | | | | | | docDate 0-1
| | | | | | | | @dateForm [Optional]
| | | | | | | season 0-1
| | | | | | | itemID 0-1
| | | | | | fabricCompos 0-1
| | | | | | | percCompos 1-9
| | | | | | | | @fibre [Required]
| | | | | | customsStat 0-1
| | | | | | grossWeight 0-1
| | | | | | | @um [Required]
| | | | | | netWeight 0-1
| | | | | | | @um [Required]
| | | | | | garSizeSet 0-1
| | | | | | | @numberingOrg [Optional]
| | | | | | | | garSizeTier 1-9
| | | | | | | | | garSizeCode 1-1
| | | | | | | | | sizeStart 1-1
| | | | | | | | | sizeEnd 0-1
| | | | | | | garMeaSet 0-99
| | | | | | | | garAttrib 1-1
| | | | | | | | | garMea 1-9
| | | | | | | | | | size 0-1
| | | | | | | | | | | @codeList [Optional]
| | | | | | | | | | specValue 1-1
| | | | | | | | | | | @um [Optional]
| | | | | | | | | | | @source [Optional]
| | | | | | | | | | | @method [Optional]
| | | | | | | | | | | @application [Optional]
| | | | | | | | | | | @CV [Optional]
| | | | | | | garConsumptionSet 0-99
- choose -
| | | | | | acsCode 1-1
| | | | | | | @numberingOrg [Optional]
| | | | | | | | art 1-1
| | | | | | | | | @numberingOrg [Optional]
| | | | | | | | | @codeList [Optional]
| | | | | | | | | @listName [Optional]
| | | | | | | | | @listVersion [Optional]
| | | | | | | | pattern 0-1
| | | | | | | | | @numberingOrg [Optional]
| | | | | | | | | @codeList [Optional]
| | | | | | | | | @listName [Optional]

```

```

| | | | | @listVersion [Optional]
| | | | | color 0-1
| | | | | @numberingOrg [Optional]
| | | | | @codeList [Optional]
| | | | | @listName [Optional]
| | | | | @listVersion [Optional]
| | | | | added 0-9
| | | | | @numberingOrg [Optional]
| | | | | @addType [Optional]
| | | | | description 0-1
| | | | |
| | | | | - or -
| | | | | texCode 1-1
| | | | | @numberingOrg [Optional]
| | | | | art 1-1
| | | | | @numberingOrg [Optional]
| | | | | @codeList [Optional]
| | | | | @listName [Optional]
| | | | | @listVersion [Optional]
| | | | | pattern 0-1
| | | | | @numberingOrg [Optional]
| | | | | @codeList [Optional]
| | | | | @listName [Optional]
| | | | | @listVersion [Optional]
| | | | | color 0-1
| | | | | @numberingOrg [Optional]
| | | | | @codeList [Optional]
| | | | | @listName [Optional]
| | | | | @listVersion [Optional]
| | | | | added 0-9
| | | | | @numberingOrg [Optional]
| | | | | @addType [Optional]
| | | | | description 0-1
| | | | |
| | | | | - or -
| | | | | yarnCode 1-1
| | | | | @numberingOrg [Optional] [Default= CL]
| | | | | art 1-1
| | | | | @numberingOrg [Optional]
| | | | | @codeList [Optional]
| | | | | @listName [Optional]
| | | | | @listVersion [Optional]
| | | | | color 0-1
| | | | | @numberingOrg [Optional]
| | | | | @codeList [Optional]
| | | | | @listName [Optional]
| | | | | @listVersion [Optional]
| | | | | added 0-9
| | | | | @numberingOrg [Optional]
| | | | | @addType [Optional]
| | | | | description 0-1
| | | | |
| | | | | - end choose -
| | | | | garConsumption 1-9
| | | | | @numberingOrg [Optional]
| | | | | garSizeCode 0-1
| | | | | qty 1-1
| | | | | @um [Required]
| | | | | qtyVariance 0-1
| | | | | @um [Optional]
| | | | | @varReason [Optional]
| | | | |
| | | | | mnfrNote 0-99
| | | | | @subject [Optional]
| | | | | image 0-99

```

```

| | | | @subject [Optional]
| | | | progress 0-9
| | | | qty 1-2
| | | | @um [Required]
| | | | deliveryDate 0-1
| | | | @dateForm [Optional]
| | | | delGrantedDate 0-1
| | | | @dateForm [Optional]
| | | | - choose -
| | | | | mfrStatus 0-1
| | | | - or -
| | | | | mfrStatusText 0-1
| | | | - end choose -
| | | | apparelComponent 0-9
| | | | | gPart 0-1
| | | | | yarnComponent 0-9
| | | | | | @CQQ [Optional]
| | | | | | pcQty 0-1
| | | | | | @um [Optional]
| | | | | | yarnCode 1-1
| | | | | | | @numberingOrg [Optional] [Default= CL]
| | | | | | | | art 1-1
| | | | | | | | @numberingOrg [Optional]
| | | | | | | | @codeList [Optional]
| | | | | | | | @listName [Optional]
| | | | | | | | @listVersion [Optional]
| | | | | | | color 0-1
| | | | | | | | @numberingOrg [Optional]
| | | | | | | | @codeList [Optional]
| | | | | | | | @listName [Optional]
| | | | | | | | @listVersion [Optional]
| | | | | | | added 0-9
| | | | | | | | @numberingOrg [Optional]
| | | | | | | | @addType [Optional]
| | | | | | | description 0-1
| | | | | lotN 0-1
| | | | | | @numberingOrg [Optional]
| | | | | dyeN 0-1
| | | | | | @numberingOrg [Optional]
| | | | | qty 1-2
| | | | | @um [Required]
| | | | | refDoc 0-1
| | | | | | @docType [Required]
| | | | | | | docID 1-2
| | | | | | | | @numberingOrg [Optional]
| | | | | | | docDate 0-1
| | | | | | | | @dateForm [Optional]
| | | | | | | season 0-1
| | | | | | | itemID 0-1
| | | | | location 0-1
| | | | | | @LRI [Optional]
| | | | | warpLetter 0-1
| | | | | weftLetter 0-1
| | | | | note 0-19
| | | | | | @numberingOrg [Optional]
| | | | | | @codeList [Optional]
| | | | | | @noteLabel [Optional]
| | | | | fabricComponent 0-9
| | | | | | texCode 1-1
| | | | | | | @numberingOrg [Optional]
| | | | | | | | art 1-1

```

| @numberingOrg [Optional]
 | @codeList [Optional]
 | @listName [Optional]
 | @listVersion [Optional]
 | pattern 0-1
 | @numberingOrg [Optional]
 | @codeList [Optional]
 | @listName [Optional]
 | @listVersion [Optional]
 | color 0-1
 | @numberingOrg [Optional]
 | @codeList [Optional]
 | @listName [Optional]
 | @listVersion [Optional]
 | added 0-9
 | @numberingOrg [Optional]
 | @addType [Optional]
 | description 0-1
 qty 1-3
 @um [Required]
 serialN 0-99
 @numberingOrg [Optional]
refDoc 0-1
 @docType [Required]
 | docID 1-2
 | @numberingOrg [Optional]
 | docDate 0-1
 | @dateForm [Optional]
 | season 0-1
 | itemID 0-1
 location 0-1
 @LRI [Optional]
 note 0-19
 @numberingOrg [Optional]
 @codeList [Optional]
 @noteLabel [Optional]
garmentPartComponent 0-9
garmentPartCode 1-1
 @numberingOrg [Optional]
 | gPart 1-1
 | mod 1-1
 | @numberingOrg [Optional]
 | @codeList [Optional]
 | @listName [Optional]
 | @listVersion [Optional]
 fabric 0-1
 @numberingOrg [Optional]
 @codeList [Optional]
 @listName [Optional]
 @listVersion [Optional]
 color 0-1
 @numberingOrg [Optional]
 @codeList [Optional]
 @listName [Optional]
 @listVersion [Optional]
 size 0-1
 @codeList [Optional]
 description 0-1
 lotN 0-1
 @numberingOrg [Optional]
 dyeN 0-1

| @numberingOrg [Optional]
 | qty 1-2
 | @um [Required]
 | **refDoc 0-1**
 | @docType [Required]
 | | docID 1-2
 | | | @numberingOrg [Optional]
 | | docDate 0-1
 | | | @dateForm [Optional]
 | | season 0-1
 | | itemID 0-1
 | location 0-1
 | @LRI [Optional]
 | note 0-19
 | | @numberingOrg [Optional]
 | | @codeList [Optional]
 | | @noteLabel [Optional]

| **acsComponent 0-99**

| **acsCode 1-1**
 | @numberingOrg [Optional]
 | | art 1-1
 | | | @numberingOrg [Optional]
 | | | @codeList [Optional]
 | | | @listName [Optional]
 | | | @listVersion [Optional]
 | | pattern 0-1
 | | | @numberingOrg [Optional]
 | | | @codeList [Optional]
 | | | @listName [Optional]
 | | | @listVersion [Optional]
 | | color 0-1
 | | | @numberingOrg [Optional]
 | | | @codeList [Optional]
 | | | @listName [Optional]
 | | | @listVersion [Optional]
 | | added 0-9
 | | | @numberingOrg [Optional]
 | | | @addType [Optional]
 | | description 0-1
 | lotN 0-1
 | | @numberingOrg [Optional]
 | dyeN 0-1
 | | @numberingOrg [Optional]
 | qty 1-2
 | @um [Required]
 | **refDoc 0-1**
 | @docType [Required]
 | | docID 1-2
 | | | @numberingOrg [Optional]
 | | docDate 0-1
 | | | @dateForm [Optional]
 | | season 0-1
 | | itemID 0-1
 | location 0-1
 | @LRI [Optional]
 | note 0-19
 | | @numberingOrg [Optional]
 | | @codeList [Optional]
 | | @noteLabel [Optional]

| **appMnfrOperation 0-9**

- choose -

```

| | | | jobName 1-1
| | | | - or -
| | | | appJob 1-1
| | | | - end choose -
| | | | appJobTech 0-1
| | | | refDoc 0-1
| | | | | @docType [Required]
| | | | | | docID 1-2
| | | | | | | @numberingOrg [Optional]
| | | | | | | docDate 0-1
| | | | | | | | @dateForm [Optional]
| | | | | | | | season 0-1
| | | | | | | | itemID 0-1
| | | | | appMachine 0-1
| | | | | note 0-19
| | | | | | @numberingOrg [Optional]
| | | | | | @codeList [Optional]
| | | | | | @noteLabel [Optional]
| | | | dtScheme 0-1
| | | | | @taxType [Required]
| | | | | | taxCategory 0-1
| | | | | | taxRate 0-1
| | | | | | legalRef 0-1
| | | | | | | @codeList [Required]
| | | | | | | note 0-19
| | | | | | | | @numberingOrg [Optional]
| | | | | | | | @codeList [Optional]
| | | | | | | | @noteLabel [Optional]

```

2.2 Detailed description of document elements

Following tables show all elements (complex and simple) used in this document. Description includes: 1) element's information: xml tag, name, brief description, data type and syntax constraints; 2) information about use of the element in a particular position in the document: xpath and possible associated notes.

2.2.1 Complex elements (Aggregate Business Information Entities)

Complex elements are those elements whose content is composed of other elements (childs).Complex elements are alphabetically ordered.

acsCode	full codification identifying an accessory product usually coupled with garment (XPath: KnitClothOrder/KCCObody/KCCOitem/apparelComponent/acsComponent/acsCode) 1-1 (XPath: KnitClothOrder/KCCObody/KCCOitem/garTecSheet/garConsumptionSet/acsCode) 1-1
acsComponent	identification details of a garment accessory used in a sub-contracted manufacturing operation (XPath: KnitClothOrder/KCCObody/KCCOitem/apparelComponent/acsComponent) 0-99
allowanceCharge	Allowances and Charges related to an Order or a contract (XPath: KnitClothOrder/terms/allowanceCharge) 0-9
apparelComponent	identification details of a component used in the sub-contracted production of an apparel article or of one of its part (knitwear/clothing) (XPath: KnitClothOrder/KCCObody/KCCOitem/apparelComponent) 0-9
apparelProd	manufacturing specifications for a knitwear/clothing article to be obtained from an operation of sub-contracted production (XPath: KnitClothOrder/KCCObody/KCCOitem/apparelProd) 1-1
appMnfrOperation	details of a manufacturing operation used for knitting/clothing (XPath: KnitClothOrder/KCCObody/KCCOitem/appMnfrOperation) 0-9
buyer	details of the Buyer - base type: Nad, (XPath: KnitClothOrder/KCCOheader/buyer) 1-1
csRange	range of color-size for a garment article (knitwear/clothing) (XPath: KnitClothOrder/KCCObody/KCCOitem/apparelProd/csRange) 0-99
dtScheme	set of data usable to declare the duty or tax applied (XPath: KnitClothOrder/terms/allowanceCharge/dtScheme) 0-1 (XPath: KnitClothOrder/KCCObody/KCCOitem/dtScheme) 0-1
fabricComponent	identification details of a fabric used in a sub-contracted manufacturing operation (XPath: KnitClothOrder/KCCObody/KCCOitem/apparelComponent/fabricComponent) 0-9
fabricCompos	composition of the fabric according to the Directory 97/37/CE (XPath: KnitClothOrder/KCCObody/KCCOitem/garTecSheet/fabricCompos) 0-1
garConsumption	consumption of the component for the given size range (XPath: KnitClothOrder/KCCObody/KCCOitem/garTecSheet/garConsumptionSet/garConsumption) 1-9
garConsumptionSet	components and average prescribed or effective consumptions for a

	garment (XPath: KnitClothOrder/KCCObody/KCCOitem/garTecSheet/garConsumptionSet) 0-99
garMea	attribute's measure for the given size (XPath: KnitClothOrder/KCCObody/KCCOitem/garTecSheet/garMeaSet/garMea) 1-9
garMeaSet	physical measures of the set of sizes of a garment (XPath: KnitClothOrder/KCCObody/KCCOitem/garTecSheet/garMeaSet) 0-99
garmentCode	codification of the garment product (knitwear/clothing) (XPath: KnitClothOrder/KCCObody/KCCOitem/garTecSheet/garmentCode) 1-2 (XPath: KnitClothOrder/KCCObody/KCCOitem/apparelProd/garmentCode) 1-2
garmentCodeA	codification of the garment product (knitwear/clothing) - type A (XPath: KnitClothOrder/KCCObody/KCCOitem/apparelProd/garmentCode/garmentCodeA) 1-1 - note: <i>here the barcode EAN-13 or EAN-8 should be specified</i> (XPath: KnitClothOrder/KCCObody/KCCOitem/garTecSheet/garmentCode/garmentCodeA) 1-1 - note: <i>here the barcode EAN-13 or EAN-8 should be specified</i>
garmentCodeB	codification of the garment product (knitwear/clothing) - type B (XPath: KnitClothOrder/KCCObody/KCCOitem/garTecSheet/garmentCode/garmentCodeB) 1-1 (XPath: KnitClothOrder/KCCObody/KCCOitem/apparelProd/garmentCode/garmentCodeB) 1-1
garmentPartCode	codification of the component or part of a garment article (knitwear or clothing) (XPath: KnitClothOrder/KCCObody/KCCOitem/apparelComponent/garmentPartComponent/garmentPartCode) 1-1 (XPath: KnitClothOrder/KCCObody/KCCOitem/apparelProd/garmentPartCode) 1-1
garmentPartComponent	identification details of a garment part used in a sub-contracted manufacturing operation (XPath: KnitClothOrder/KCCObody/KCCOitem/apparelComponent/garmentPartComponent) 0-9
garSizeSet	size table for a garment (XPath: KnitClothOrder/KCCObody/KCCOitem/garTecSheet/garSizeSet) 0-1
garSizeTier	definition of the range of sizes associated with a given code (XPath: KnitClothOrder/KCCObody/KCCOitem/garTecSheet/garSizeSet/garSizeTier) 1-9
garTecSheet	garment technical sheet (XPath: KnitClothOrder/KCCObody/KCCOitem/garTecSheet) 0-1
insPayment	payment details for payment by installments (XPath: KnitClothOrder/terms/insPayment) 0-5 - note: <i>excluded the case of offers, this set of data is alternative to payment set and must be iterated for each payment installment</i>
KCCObody	body of the document KNITTING/CLOTHING COMMISSION ORDER (XPath: KnitClothOrder/KCCObody) 1-1
KCCOheader	header of the document KNITTING/CLOTHING COMMISSION ORDER (XPath: KnitClothOrder/KCCOheader) 1-1
KCCOitem	line of the document KNITTING/CLOTHING COMMISSION ORDER (XPath: KnitClothOrder/KCCObody/KCCOitem) 1-unbounded
payment	payment details for payment all in one (XPath: KnitClothOrder/terms/payment) 0-5 - note: <i>excluded the case of offers, this set of data is alternative to</i>

	<i>insPayment</i> , it can be iterated to specify alternative terms of payment (e.g.: 60 days or 30 days with 3% discount)
progress	description of the progress of a production lot in a manufacturing process (XPath: KnitClothOrder/KCCObody/KCCOitem/progress) 0-9
refDoc	identification of a document and of an item thereof, to which the message makes reference (XPath: KnitClothOrder/KCCObody/KCCOitem/apparelComponent/garmentPartComponent/refDoc) 0-1 (XPath: KnitClothOrder/KCCObody/KCCOitem/appMnfrOperation/refDoc) 0-1 (XPath: KnitClothOrder/KCCObody/KCCOitem/apparelComponent/fabricComponent/refDoc) 0-1 - note: <i>here the delivery documents can be specified</i> (XPath: KnitClothOrder/KCCObody/KCCOitem/apparelComponent/yarnComponent/refDoc) 0-1 - note: <i>here the delivery document can be specified</i> (XPath: KnitClothOrder/KCCOheader/refDoc) 0-9 (XPath: KnitClothOrder/KCCObody/KCCOitem/garTecSheet/refDoc) 0-9 (XPath: KnitClothOrder/KCCObody/KCCOitem/apparelComponent/acsComponent/refDoc) 0-1
sizeMatrix	size matrix of an apparel product (knitwear/clothing) (XPath: KnitClothOrder/KCCObody/KCCOitem/apparelProd/csRange/sizeMatrix) 1-1
sizeRow	size matrix row of an apparel product (knitwear/clothing) (XPath: KnitClothOrder/KCCObody/KCCOitem/apparelProd/csRange/sizeMatrix/sizeRow) 1-99
subContractor	details of the Sub-contractor - base type: Nad, (XPath: KnitClothOrder/KCCOheader/subContractor) 1-1
terms	details of the commercial obligations for payment and delivery (XPath: KnitClothOrder/terms) 0-1
texCode	full codification of the textile product (XPath: KnitClothOrder/KCCObody/KCCOitem/apparelComponent/fabricComponent/texCode) 1-1 (XPath: KnitClothOrder/KCCObody/KCCOitem/garTecSheet/garConsumptionSet/texCode) 1-1
thirdParty	details of the Third Party, different from Buyer or Supplier - base type: Nad, (XPath: KnitClothOrder/KCCObody/KCCOitem/thirdParty) 0-5 (XPath: KnitClothOrder/KCCOheader/thirdParty) 0-1 - note: <i>here the Party to whom the Subcontractor must send the semi-finished products for subsequent operations can be specified</i>
trade	general terms of trade for the specified supply (XPath: KnitClothOrder/terms/trade) 0-1
transInfo	details of transport: mode, carrier and delivery place (XPath: KnitClothOrder/terms/transInfo) 0-1
yarnCode	full codification of a yarn product (XPath: KnitClothOrder/KCCObody/KCCOitem/apparelComponent/yarnComponent/yarnCode) 1-1 - note: <i>here is the code of the component used in the yarn manufacturing operation</i> (XPath: KnitClothOrder/KCCObody/KCCOitem/garTecSheet/garConsumptionSet/yarnCode) 1-1
yarnComponent	identification details of a yarn used in a sub-contracted manufacturing operation

	(XPath: KnitClothOrder/KCCObody/KCCOitem/apparelComponent/yarnComponent) 0-9
--	---

2.2.2 Simple elements (Basic Business Information Entities)

Simple elements are those elements whose content is characterized by a data type plus a domain of possible values. Simple elements are alphabetically ordered.

AC_amount	amount of an Allowance or Charge - base type: decimal, fraction digits: 2, (XPath: KnitClothOrder/terms/allowanceCharge/AC_amount) 1-1
AC_category	coded specification of an Allowance or Charge - base type: string, cod. table: T41 http://www.moda-ml.net/moda-ml/repository/codelist/v2013-1/gc_T41.xml (XPath: KnitClothOrder/terms/allowanceCharge/AC_category) 1-1
AC_categoryText	free text description of an Allowance or Charge - base type: string, max length: 70, (XPath: KnitClothOrder/terms/allowanceCharge/AC_categoryText) 1-1
AC_percent	amount of an Allowance or Charge as a percentage - base type: decimal, max inclusive: 100, fraction digits: 2, (XPath: KnitClothOrder/terms/allowanceCharge/AC_percent) 1-1
added	additional code of the product (complementing the formers) - base type: string, max length: 15, (XPath: KnitClothOrder/KCCObody/KCCOitem/garTecSheet/ garConsumptionSet/texCode/added) 0-9 - note: <i>here an additional codification (see table T44) can be specified</i> (XPath: KnitClothOrder/KCCObody/KCCOitem/apparelProd/ garmentCode/garmentCodeB/added) 0-9 (XPath: KnitClothOrder/KCCObody/KCCOitem/garTecSheet/ garConsumptionSet/yarnCode/added) 0-9 - note: <i>here an additional codification (see table T44) can be specified</i> (XPath: KnitClothOrder/KCCObody/KCCOitem/garTecSheet/ garConsumptionSet/acsCode/added) 0-9 - note: <i>here an additional codification (see table T44) can be specified</i> (XPath: KnitClothOrder/KCCObody/KCCOitem/garTecSheet/ garmentCode/garmentCodeB/added) 0-9 (XPath: KnitClothOrder/KCCObody/KCCOitem/apparelComponent/ fabricComponent/texCode/added) 0-9 - note: <i>here an additional codification (see table T44) can be specified</i> (XPath: KnitClothOrder/KCCObody/KCCOitem/apparelComponent/ acsComponent/acsCode/added) 0-9 - note: <i>here an additional codification (see table T44) can be specified</i> (XPath: KnitClothOrder/KCCObody/KCCOitem/apparelComponent/ yarnComponent/yarnCode/added) 0-9 - note: <i>here an additional codification (see table T44) can be specified</i>
@addType	qualifier of the additional coding of a product - base type: string, cod. table: T44 http://www.moda-ml.net/moda-ml/repository/codelist/v2013-1/gc_T44.xml (XPath: KnitClothOrder/KCCObody/KCCOitem/garTecSheet/ garmentCode/garmentCodeB/added/@addType) [Optional] (XPath: KnitClothOrder/KCCObody/KCCOitem/apparelProd/

	<p>garmentCode/garmentCodeB/added/@addType) [Optional] (XPath: KnitClothOrder/KCCObody/KCCOitem/garTecSheet/ garConsumptionSet/acsCode/added/@addType) [Optional] (XPath: KnitClothOrder/KCCObody/KCCOitem/garTecSheet/ garConsumptionSet/yarnCode/added/@addType) [Optional] (XPath: KnitClothOrder/KCCObody/KCCOitem/apparelComponent/ yarnComponent/yarnCode/added/@addType) [Optional] (XPath: KnitClothOrder/KCCObody/KCCOitem/apparelComponent/ acsComponent/acsCode/added/@addType) [Optional] (XPath: KnitClothOrder/KCCObody/KCCOitem/apparelComponent/ fabricComponent/texCode/added/@addType) [Optional] (XPath: KnitClothOrder/KCCObody/KCCOitem/garTecSheet/ garConsumptionSet/texCode/added/@addType) [Optional]</p>
appJob	<p>operation of a work cycle for knitting/clothing - base type: string, cod. table: T205 http://www.moda-ml.net/moda-ml/repository/codelist/v2013-1/gc_T205.xml (XPath: KnitClothOrder/KCCObody/KCCOitem/appMnfrOperation/appJob) 1-1</p>
appJobTech	<p>operation technology for knitting/clothing - base type: string, cod. table: T265 http://www.moda-ml.net/moda-ml/repository/codelist/v2013-1/gc_T265.xml (XPath: KnitClothOrder/KCCObody/KCCOitem/appMnfrOperation/appJobTech) 0-1</p>
@application	<p>force or similar condition (e.g. no. of revolutions) applied in a test as specified within the standard - base type: string, max length: 15, (XPath: KnitClothOrder/KCCObody/KCCOitem/garTecSheet/ garMeaSet/garMea/specValue/@application) [Optional]</p>
appMachine	<p>machine used in an operation of a work cycle for knitting/clothing - base type: string, cod. table: T275 http://www.moda-ml.net/moda-ml/repository/codelist/v2013-1/gc_T275.xml (XPath: KnitClothOrder/KCCObody/KCCOitem/appMnfrOperation/appMachine) 0-1</p>
art	<p>article number of the product - base type: string, max length: 25, (XPath: KnitClothOrder/KCCObody/KCCOitem/garTecSheet/ garConsumptionSet/yarnCode/art) 1-1 (XPath: KnitClothOrder/KCCObody/KCCOitem/apparelComponent/ yarnComponent/yarnCode/art) 1-1 (XPath: KnitClothOrder/KCCObody/KCCOitem/garTecSheet/ garConsumptionSet/texCode/art) 1-1 - note: can be used either for the base-article (excluding pattern/colour) or for the SKU (XPath: KnitClothOrder/KCCObody/KCCOitem/apparelComponent/ fabricComponent/texCode/art) 1-1 - note: can be used either for the base-article (excluding pattern/colour) or for the SKU (XPath: KnitClothOrder/KCCObody/KCCOitem/apparelComponent/ acsComponent/acsCode/art) 1-1 (XPath: KnitClothOrder/KCCObody/KCCOitem/garTecSheet/ garmentCode/garmentCodeA/art) 1-1 (XPath: KnitClothOrder/KCCObody/KCCOitem/apparelProd/ garmentCode/garmentCodeA/art) 1-1 (XPath: KnitClothOrder/KCCObody/KCCOitem/garTecSheet/ garConsumptionSet/acsCode/art) 1-1</p>
artGroup	<p>code identifying a class of products - base type: string, max length: 40, (XPath: KnitClothOrder/KCCObody/KCCOitem/apparelProd/ garmentCode/garmentCodeB/artGroup) 0-1 (XPath: KnitClothOrder/KCCObody/KCCOitem/garTecSheet/</p>

	garmentCode/garmentCodeB/artGroup) 0-1
carrier	<p>identification of the transport carrier</p> <p>- base type: string, max length: 40, (XPath: KnitClothOrder/terms/transInfo/carrier) 0-1</p>
city	<p>name of the city (town, village)</p> <p>- base type: string, max length: 40, (XPath: KnitClothOrder/KCCObody/KCCOitem/thirdParty/city) 0-1 (XPath: KnitClothOrder/KCCOheader/subContractor/city) 0-1 (XPath: KnitClothOrder/KCCOheader/thirdParty/city) 0-1 (XPath: KnitClothOrder/KCCOheader/buyer/city) 0-1</p>
@codeList	<p>it specifies the URL where the list of codes used to make an instance of the element can be found</p> <p>- base type: string, max length: 255, (XPath: KnitClothOrder/KCCObody/KCCOitem/garTecSheet/garmentCode/garmentCodeB/mod/@codeList) [Optional]</p> <p>- nota: <i>this attribute should be ALTERNATIVE to the others</i> (XPath: KnitClothOrder/KCCObody/KCCOitem/apparelProd/csRange/color/@codeList) [Optional]</p> <p>- nota: <i>this attribute should be ALTERNATIVE to the others</i> (XPath: KnitClothOrder/KCCObody/KCCOitem/apparelComponent/acsComponent/acsCode/color/@codeList) [Optional]</p> <p>- nota: <i>this attribute should be ALTERNATIVE to the others</i> (XPath: KnitClothOrder/KCCObody/KCCOitem/apparelComponent/yarnComponent/yarnCode/art/@codeList) [Optional]</p> <p>- nota: <i>this attribute should be ALTERNATIVE to the others</i> (XPath: KnitClothOrder/KCCObody/KCCOitem/garTecSheet/garConsumptionSet/texCode/art/@codeList) [Optional]</p> <p>- nota: <i>this attribute should be ALTERNATIVE to the others</i> (XPath: KnitClothOrder/KCCObody/KCCOitem/garTecSheet/garConsumptionSet/yarnCode/art/@codeList) [Optional]</p> <p>- nota: <i>this attribute should be ALTERNATIVE to the others</i> (XPath: KnitClothOrder/KCCObody/KCCOitem/garTecSheet/garConsumptionSet/texCode/pattern/@codeList) [Optional]</p> <p>- nota: <i>this attribute should be ALTERNATIVE to the others</i> (XPath: KnitClothOrder/KCCObody/KCCOitem/apparelProd/garmentCode/garmentCodeB/mod/@codeList) [Optional]</p> <p>- nota: <i>this attribute should be ALTERNATIVE to the others</i> (XPath: KnitClothOrder/KCCObody/KCCOitem/garTecSheet/garmentCode/garmentCodeB/fabric/@codeList) [Optional]</p> <p>- nota: <i>this attribute should be ALTERNATIVE to the others</i> (XPath: KnitClothOrder/KCCObody/KCCOitem/apparelProd/garmentPartCode/color/@codeList) [Optional]</p> <p>- nota: <i>this attribute should be ALTERNATIVE to the others</i> (XPath: KnitClothOrder/KCCObody/KCCOitem/apparelProd/garmentCode/garmentCodeB/fabric/@codeList) [Optional]</p> <p>- nota: <i>this attribute should be ALTERNATIVE to the others</i> (XPath: KnitClothOrder/KCCObody/KCCOitem/apparelComponent/acsComponent/acsCode/art/@codeList) [Optional]</p> <p>- nota: <i>this attribute should be ALTERNATIVE to the others</i> (XPath: KnitClothOrder/KCCObody/KCCOitem/dtScheme/legalRef/@codeList) [Required] (XPath: KnitClothOrder/KCCObody/KCCOitem/dtScheme/note/@codeList) [Optional]</p> <p>- nota: <i>must be used to provide (URL) the list of codes used in "noteLabel"</i> (XPath: KnitClothOrder/KCCObody/KCCOitem/apparelProd/csRange/sizeMatrix/sizeRow/drop/@codeList) [Optional] (XPath: KnitClothOrder/KCCObody/KCCOitem/apparelProd/garmentPartCode/size/@codeList) [Optional] (XPath: KnitClothOrder/KCCObody/KCCOitem/appMnfrOperation/</p>

	<p style="text-align: center;">note/@codeList) [Optional]</p> <p>- nota: <i>must be used to provide (URL) the list of codes used in "noteLabel"</i></p> <p>(XPath: KnitClothOrder/KCCObody/KCCOitem/apparelProd/garmentCode/garmentCodeB/color/@codeList) [Optional]</p> <p>- nota: <i>this attribute should be ALTERNATIVE to the others</i></p> <p>(XPath: KnitClothOrder/KCCObody/KCCOitem/apparelComponent/acsComponent/acsCode/pattern/@codeList) [Optional]</p> <p>- nota: <i>this attribute should be ALTERNATIVE to the others</i></p> <p>(XPath: KnitClothOrder/KCCObody/KCCOitem/apparelProd/garmentPartCode/mod/@codeList) [Optional]</p> <p>- nota: <i>this attribute should be ALTERNATIVE to the others</i></p> <p>(XPath: KnitClothOrder/KCCObody/KCCOitem/garTecSheet/garConsumptionSet/texCode/color/@codeList) [Optional]</p> <p>- nota: <i>this attribute should be ALTERNATIVE to the others</i></p> <p>(XPath: KnitClothOrder/KCCObody/KCCOitem/apparelComponent/garmentPartComponent/note/@codeList) [Optional]</p> <p>- nota: <i>must be used to provide (URL) the list of codes used in "noteLabel"</i></p> <p>(XPath: KnitClothOrder/KCCObody/KCCOitem/apparelProd/garmentPartCode/fabric/@codeList) [Optional]</p> <p>- nota: <i>this attribute should be ALTERNATIVE to the others</i></p> <p>(XPath: KnitClothOrder/KCCObody/KCCOitem/apparelProd/csRange/sizeMatrix/sizeRow/size/@codeList) [Optional]</p> <p>(XPath: KnitClothOrder/KCCObody/KCCOitem/garTecSheet/garmentCode/garmentCodeB/color/@codeList) [Optional]</p> <p>- nota: <i>this attribute should be ALTERNATIVE to the others</i></p> <p>(XPath: KnitClothOrder/KCCObody/KCCOitem/apparelComponent/fabricComponent/texCode/art/@codeList) [Optional]</p> <p>- nota: <i>this attribute should be ALTERNATIVE to the others</i></p> <p>(XPath: KnitClothOrder/KCCObody/KCCOitem/garTecSheet/garConsumptionSet/acsCode/pattern/@codeList) [Optional]</p> <p>- nota: <i>this attribute should be ALTERNATIVE to the others</i></p> <p>(XPath: KnitClothOrder/KCCObody/KCCOitem/apparelComponent/fabricComponent/texCode/pattern/@codeList) [Optional]</p> <p>- nota: <i>this attribute should be ALTERNATIVE to the others</i></p> <p>(XPath: KnitClothOrder/KCCObody/KCCOitem/apparelComponent/yarnComponent/note/@codeList) [Optional]</p> <p>- nota: <i>must be used to provide (URL) the list of codes used in "noteLabel"</i></p> <p>(XPath: KnitClothOrder/KCCOheader/note/@codeList) [Optional]</p> <p>- nota: <i>must be used to provide (URL) the list of codes used in "noteLabel"</i></p> <p>(XPath: KnitClothOrder/KCCObody/KCCOitem/garTecSheet/garmentCode/garmentCodeA/art/@codeList) [Optional]</p> <p>- nota: <i>this attribute should be ALTERNATIVE to the others</i></p> <p>(XPath: KnitClothOrder/KCCObody/KCCOitem/garTecSheet/garConsumptionSet/yarnCode/color/@codeList) [Optional]</p> <p>- nota: <i>this attribute should be ALTERNATIVE to the others</i></p> <p>(XPath: KnitClothOrder/KCCObody/KCCOitem/apparelProd/garmentCode/garmentCodeA/art/@codeList) [Optional]</p> <p>- nota: <i>this attribute should be ALTERNATIVE to the others</i></p> <p>(XPath: KnitClothOrder/KCCObody/KCCOitem/apparelComponent/acsComponent/note/@codeList) [Optional]</p> <p>- nota: <i>must be used to provide (URL) the list of codes used in "noteLabel"</i></p> <p>(XPath: KnitClothOrder/KCCObody/KCCOitem/garTecSheet/garmentCode/garmentCodeB/artGroup/@codeList) [Optional]</p> <p>- nota: <i>this attribute should be ALTERNATIVE to the others</i></p> <p>(XPath: KnitClothOrder/KCCObody/KCCOitem/apparelComponent/fabricComponent/note/@codeList) [Optional]</p> <p>- nota: <i>must be used to provide (URL) the list of codes used in "noteLabel"</i></p>
--	--

	<p>(XPath: KnitClothOrder/KCCObody/KCCOitem/apparelComponent/fabricComponent/texCode/color/@codeList) [Optional]</p> <p>- nota: <i>this attribute should be ALTERNATIVE to the others</i></p> <p>(XPath: KnitClothOrder/KCCObody/KCCOitem/garTecSheet/garConsumptionSet/acsCode/color/@codeList) [Optional]</p> <p>- nota: <i>this attribute should be ALTERNATIVE to the others</i></p> <p>(XPath: KnitClothOrder/KCCObody/KCCOitem/garTecSheet/garMeaSet/garMea/size/@codeList) [Optional]</p> <p>(XPath: KnitClothOrder/KCCObody/KCCOitem/apparelComponent/garmentPartComponent/garmentPartCode/size/@codeList) [Optional]</p> <p>(XPath: KnitClothOrder/terms/allowanceCharge/dtScheme/legalRef/@codeList) [Required]</p> <p>(XPath: KnitClothOrder/KCCObody/KCCOitem/garTecSheet/garmentCode/garmentCodeB/size/@codeList) [Optional]</p> <p>(XPath: KnitClothOrder/KCCObody/KCCOitem/apparelComponent/yarnComponent/yarnCode/color/@codeList) [Optional]</p> <p>- nota: <i>this attribute should be ALTERNATIVE to the others</i></p> <p>(XPath: KnitClothOrder/terms/allowanceCharge/dtScheme/note/@codeList) [Optional]</p> <p>- nota: <i>must be used to provide (URL) the list of codes used in "noteLabel"</i></p> <p>(XPath: KnitClothOrder/KCCObody/KCCOitem/apparelProd/garmentCode/garmentCodeB/size/@codeList) [Optional]</p> <p>(XPath: KnitClothOrder/KCCObody/KCCOitem/apparelComponent/garmentPartComponent/garmentPartCode/fabric/@codeList) [Optional]</p> <p>- nota: <i>this attribute should be ALTERNATIVE to the others</i></p> <p>(XPath: KnitClothOrder/KCCObody/KCCOitem/garTecSheet/garConsumptionSet/acsCode/art/@codeList) [Optional]</p> <p>- nota: <i>this attribute should be ALTERNATIVE to the others</i></p> <p>(XPath: KnitClothOrder/KCCObody/KCCOitem/apparelComponent/garmentPartComponent/garmentPartCode/mod/@codeList) [Optional]</p> <p>- nota: <i>this attribute should be ALTERNATIVE to the others</i></p> <p>(XPath: KnitClothOrder/KCCObody/KCCOitem/apparelProd/note/@codeList) [Optional]</p> <p>- nota: <i>must be used to provide (URL) the list of codes used in "noteLabel"</i></p> <p>(XPath: KnitClothOrder/KCCObody/KCCOitem/apparelComponent/garmentPartComponent/garmentPartCode/color/@codeList) [Optional]</p> <p>- nota: <i>this attribute should be ALTERNATIVE to the others</i></p> <p>(XPath: KnitClothOrder/KCCObody/KCCOitem/apparelProd/garmentCode/garmentCodeB/artGroup/@codeList) [Optional]</p> <p>- nota: <i>this attribute should be ALTERNATIVE to the others</i></p>
color	<p>colour number of the product, when not included in the model or fabric code</p> <p>- base type: string, max length: 15,</p> <p>(XPath: KnitClothOrder/KCCObody/KCCOitem/apparelProd/csRange/color) 0-1</p> <p>(XPath: KnitClothOrder/KCCObody/KCCOitem/garTecSheet/garmentCode/garmentCodeB/color) 0-1</p> <p>(XPath: KnitClothOrder/KCCObody/KCCOitem/garTecSheet/garConsumptionSet/acsCode/color) 0-1</p> <p>(XPath: KnitClothOrder/KCCObody/KCCOitem/apparelProd/garmentCode/garmentCodeB/color) 0-1</p> <p>(XPath: KnitClothOrder/KCCObody/KCCOitem/garTecSheet/garConsumptionSet/texCode/color) 0-1</p> <p>(XPath: KnitClothOrder/KCCObody/KCCOitem/apparelComponent/yarnComponent/yarnCode/color) 0-1</p> <p>(XPath: KnitClothOrder/KCCObody/KCCOitem/apparelProd/</p>

	<p>garmentPartCode/color) 0-1</p> <p>- note: <i>when a garment component, it should be the code assigned to the garment article</i></p> <p>(XPath: KnitClothOrder/KCCObody/KCCOitem/apparelComponent/acsComponent/acsCode/color) 0-1</p> <p>(XPath: KnitClothOrder/KCCObody/KCCOitem/apparelComponent/garmentPartComponent/garmentPartCode/color) 0-1</p> <p>- note: <i>when a garment component, it should be the code assigned to the garment article</i></p> <p>(XPath: KnitClothOrder/KCCObody/KCCOitem/apparelComponent/fabricComponent/texCode/color) 0-1</p> <p>(XPath: KnitClothOrder/KCCObody/KCCOitem/garTecSheet/garConsumptionSet/yarnCode/color) 0-1</p>
country	<p>code of the nation</p> <p>- base type: string, cod. table: T10</p> <p>http://www.moda-ml.net/moda-ml/repository/codelist/v2013-1/gc_T10.xml</p> <p>(XPath: KnitClothOrder/KCCOheader/buyer/country) 0-1</p> <p>(XPath: KnitClothOrder/KCCOheader/thirdParty/country) 0-1</p> <p>(XPath: KnitClothOrder/KCCOheader/subContractor/country) 0-1</p>
@CQQ	<p>specifies if the committed quantity can or can not include the loss in weight</p> <p>- base type: string, cod. table: NT37</p> <p>http://www.moda-ml.net/moda-ml/repository/codelist/v2013-1/gc_NT37.xml</p> <p>(XPath: KnitClothOrder/KCCObody/KCCOitem/apparelComponent/yarnComponent/@CQQ) [Optional]</p>
customsStat	<p>statistic code assigned by Customs to a specified product</p> <p>- base type: string, max length: 15,</p> <p>(XPath: KnitClothOrder/KCCObody/KCCOitem/garTecSheet/customsStat) 0-1</p>
@CV	<p>coefficient of variation (CV) of a measurement</p> <p>- base type: decimal,</p> <p>(XPath: KnitClothOrder/KCCObody/KCCOitem/garTecSheet/garMeaSet/garMea/specValue/@CV) [Optional]</p>
@dateForm	<p>format used for the date</p> <p>- base type: string, cod. table: NT29</p> <p>http://www.moda-ml.net/moda-ml/repository/codelist/v2013-1/gc_NT29.xml</p> <p>(XPath: KnitClothOrder/KCCObody/KCCOitem/apparelComponent/acsComponent/refDoc/docDate/@dateForm) [Optional]</p> <p>(XPath: KnitClothOrder/KCCObody/KCCOitem/apparelComponent/yarnComponent/refDoc/docDate/@dateForm) [Optional]</p> <p>(XPath: KnitClothOrder/KCCOheader/refDoc/docDate/@dateForm) [Optional]</p> <p>(XPath: KnitClothOrder/KCCObody/KCCOitem/garTecSheet/refDoc/docDate/@dateForm) [Optional]</p> <p>(XPath: KnitClothOrder/KCCObody/KCCOitem/progress/deliveryDate/@dateForm) [Optional]</p> <p>(XPath: KnitClothOrder/KCCObody/KCCOitem/apparelComponent/fabricComponent/refDoc/docDate/@dateForm) [Optional]</p> <p>(XPath: KnitClothOrder/KCCOheader/msgDate/@dateForm) [Optional]</p> <p>(XPath: KnitClothOrder/KCCObody/KCCOitem/deliveryDate/@dateForm) [Optional]</p> <p>(XPath: KnitClothOrder/KCCObody/KCCOitem/progress/delGrantedDate/@dateForm) [Optional]</p> <p>(XPath: KnitClothOrder/KCCObody/KCCOitem/apparelComponent/garmentPartComponent/refDoc/docDate/@dateForm) [Optional]</p> <p>(XPath: KnitClothOrder/KCCObody/KCCOitem/appMnfrOperation/refDoc/docDate/@dateForm) [Optional]</p>
delGrantedDate	<p>effective date of delivery of goods (granted in the Order Status Report); incase of doubt delivery must be understood as the event</p>

	<p>when the ownership of goods is transferred, according to one of the patterns YYYY-MM-DD, YYYY-MM-DD:HH-MM or YYYY-WW. - base type: string, (XPath: KnitClothOrder/KCCObody/KCCOitem/progress/delGrantedDate) 0-1</p>
deliveryDate	<p>date of delivery of goods, requested or promised in the purchase process, according to one of the patterns YYYY-MM-DD, YYYY-MM-DD:HH-MM or YYYY-WW. - base type: string, (XPath: KnitClothOrder/KCCObody/KCCOitem/progress/deliveryDate) 0-1 (XPath: KnitClothOrder/KCCObody/KCCOitem/deliveryDate) 0-1</p>
deliveryPlace	<p>place of delivery of goods, ultimate or related to a given leg - base type: string, max length: 40, (XPath: KnitClothOrder/terms/transInfo/deliveryPlace) 0-1</p>
dept	<p>name or code of a contact department within a Party - base type: string, max length: 40, (XPath: KnitClothOrder/KCCOheader/subContractor/dept) 0-1 (XPath: KnitClothOrder/KCCObody/KCCOitem/thirdParty/dept) 0-1 (XPath: KnitClothOrder/KCCOheader/buyer/dept) 0-1 (XPath: KnitClothOrder/KCCOheader/thirdParty/dept) 0-1</p>
description	<p>free text description of a product - base type: string, max length: 70, (XPath: KnitClothOrder/KCCObody/KCCOitem/apparelProd/garmentCode/garmentCodeB/description) 0-1 (XPath: KnitClothOrder/KCCObody/KCCOitem/apparelComponent/garmentPartComponent/garmentPartCode/description) 0-1 (XPath: KnitClothOrder/KCCObody/KCCOitem/garTecSheet/garConsumptionSet/yarnCode/description) 0-1 (XPath: KnitClothOrder/KCCObody/KCCOitem/apparelComponent/yarnComponent/yarnCode/description) 0-1 (XPath: KnitClothOrder/KCCObody/KCCOitem/garTecSheet/garmentCode/garmentCodeA/description) 0-1 (XPath: KnitClothOrder/KCCObody/KCCOitem/apparelComponent/fabricComponent/texCode/description) 0-1 (XPath: KnitClothOrder/KCCObody/KCCOitem/garTecSheet/garConsumptionSet/texCode/description) 0-1 (XPath: KnitClothOrder/KCCObody/KCCOitem/apparelComponent/acsComponent/acsCode/description) 0-1 (XPath: KnitClothOrder/KCCObody/KCCOitem/garTecSheet/garConsumptionSet/acsCode/description) 0-1 (XPath: KnitClothOrder/KCCObody/KCCOitem/garTecSheet/garmentCode/garmentCodeB/description) 0-1 (XPath: KnitClothOrder/KCCObody/KCCOitem/apparelProd/garmentPartCode/description) 0-1 (XPath: KnitClothOrder/KCCObody/KCCOitem/apparelProd/garmentCode/garmentCodeA/description) 0-1</p>
docDate	<p>date of issue of the referenced document, according to one of the patterns YYYY-MM-DD, YYYY-MM-DD:HH-MM or YYYY-WW. - base type: string, (XPath: KnitClothOrder/KCCObody/KCCOitem/garTecSheet/refDoc/docDate) 0-1 (XPath: KnitClothOrder/KCCObody/KCCOitem/apparelComponent/garmentPartComponent/refDoc/docDate) 0-1 (XPath: KnitClothOrder/KCCOheader/refDoc/docDate) 0-1 (XPath: KnitClothOrder/KCCObody/KCCOitem/apparelComponent/yarnComponent/refDoc/docDate) 0-1 (XPath: KnitClothOrder/KCCObody/KCCOitem/appMnfrOperation/refDoc/docDate) 0-1 (XPath: KnitClothOrder/KCCObody/KCCOitem/apparelComponent/fabricComponent/refDoc/docDate) 0-1</p>

	(XPath: KnitClothOrder/KCCObody/KCCOitem/apparelComponent/acsComponent/refDoc/docDate) 0-1
docID	<p>identification number of the referenced document SINCE 2008-1 ITS USE IN THE HEADER IS DISCOURAGED (REPLACED BY msgID)</p> <p>- base type: string, max length: 80,</p> <p>(XPath: KnitClothOrder/KCCObody/KCCOitem/garTecSheet/refDoc/docID) 1-2</p> <p>(XPath: KnitClothOrder/KCCOheader/docID) 0-1</p> <p>(XPath: KnitClothOrder/KCCObody/KCCOitem/appMnfrOperation/refDoc/docID) 1-2</p> <p>(XPath: KnitClothOrder/KCCObody/KCCOitem/apparelComponent/acsComponent/refDoc/docID) 1-2</p> <p>(XPath: KnitClothOrder/KCCOheader/refDoc/docID) 1-2</p> <p>(XPath: KnitClothOrder/KCCObody/KCCOitem/apparelComponent/garmentPartComponent/refDoc/docID) 1-2</p> <p>(XPath: KnitClothOrder/KCCObody/KCCOitem/apparelComponent/yarnComponent/refDoc/docID) 1-2</p> <p>(XPath: KnitClothOrder/KCCObody/KCCOitem/apparelComponent/fabricComponent/refDoc/docID) 1-2</p>
@docType	<p>type or class to which the referenced document belongs</p> <p>- base type: string, cod. table: T21</p> <p>http://www.moda-ml.net/moda-ml/repository/codelist/v2013-1/gc_T21.xml</p> <p>(XPath: KnitClothOrder/KCCObody/KCCOitem/apparelComponent/fabricComponent/refDoc/@docType) [Required]</p> <p>(XPath: KnitClothOrder/KCCObody/KCCOitem/apparelComponent/yarnComponent/refDoc/@docType) [Required]</p> <p>(XPath: KnitClothOrder/KCCObody/KCCOitem/apparelComponent/acsComponent/refDoc/@docType) [Required]</p> <p>(XPath: KnitClothOrder/KCCObody/KCCOitem/apparelComponent/garmentPartComponent/refDoc/@docType) [Required]</p> <p>(XPath: KnitClothOrder/KCCOheader/refDoc/@docType) [Required]</p> <p>(XPath: KnitClothOrder/KCCObody/KCCOitem/garTecSheet/refDoc/@docType) [Required]</p> <p>(XPath: KnitClothOrder/KCCObody/KCCOitem/appMnfrOperation/refDoc/@docType) [Required]</p>
drop	<p>drop number of the garment</p> <p>- base type: string, max length: 15,</p> <p>(XPath: KnitClothOrder/KCCObody/KCCOitem/apparelProd/csRange/sizeMatrix/sizeRow/drop) 0-1</p>
dyeN	<p>number of the dyeing batch of a textile product</p> <p>- base type: string, max length: 15,</p> <p>(XPath: KnitClothOrder/KCCObody/KCCOitem/apparelProd/dyeN) 0-1</p> <p>(XPath: KnitClothOrder/KCCObody/KCCOitem/apparelComponent/yarnComponent/dyeN) 0-1</p> <p>(XPath: KnitClothOrder/KCCObody/KCCOitem/apparelComponent/garmentPartComponent/dyeN) 0-1</p> <p>(XPath: KnitClothOrder/KCCObody/KCCOitem/apparelComponent/acsComponent/dyeN) 0-1</p>
@email	<p>electronic mail address of the contact person within a Party</p> <p>- base type: string, max length: 80,</p> <p>(XPath: KnitClothOrder/KCCOheader/thirdParty/person/@email) [Optional]</p> <p>(XPath: KnitClothOrder/KCCOheader/subContractor/person/@email) [Optional]</p> <p>(XPath: KnitClothOrder/KCCObody/KCCOitem/thirdParty/person/@email) [Optional]</p> <p>(XPath: KnitClothOrder/KCCOheader/buyer/person/@email) [Optional]</p>
fabric	<p>fabric number of the garment</p> <p>- base type: string, max length: 15,</p> <p>(XPath: KnitClothOrder/KCCObody/KCCOitem/garTecSheet/</p>

	<p>garmentCode/garmentCodeB/fabric) 0-1 (XPath: KnitClothOrder/KCCObody/KCCOitem/apparelComponent/ garmentPartComponent/garmentPartCode/fabric) 0-1 - note: <i>when a garment component, it should be the code assigned to the garment article</i> (XPath: KnitClothOrder/KCCObody/KCCOitem/apparelProd/ garmentPartCode/fabric) 0-1 - note: <i>when a garment component, it should be the code assigned to the garment article</i> (XPath: KnitClothOrder/KCCObody/KCCOitem/apparelProd/ garmentCode/garmentCodeB/fabric) 0-1</p>
@fax	<p>fax number of the contact person within a Party - base type: string, max length: 35, (XPath: KnitClothOrder/KCCOheader/subContractor/person/@fax) [Optional] (XPath: KnitClothOrder/KCCOheader/thirdParty/person/@fax) [Optional] (XPath: KnitClothOrder/KCCObody/KCCOitem/thirdParty/person/@fax) [Optional] (XPath: KnitClothOrder/KCCOheader/buyer/person/@fax) [Optional]</p>
@fibre	<p>type of fibre used in a textile product - base type: string, cod. table: T19 http://www.moda-ml.net/moda-ml/repository/codelist/v2013-1/gc_T19.xml (XPath: KnitClothOrder/KCCObody/KCCOitem/garTecSheet/ fabricCompos/percCompos/@fibre) [Required]</p>
@finDiscount	<p>financial discount applied for payment by the date specified - base type: decimal, min inclusive: 0, max inclusive: 100, fraction digits: 2, (XPath: KnitClothOrder/terms/payment/@finDiscount) [Optional]</p>
@finSurcharge	<p>financial surcharge applied for payment after the date specified - base type: decimal, min inclusive: 0, max inclusive: 100, fraction digits: 2, (XPath: KnitClothOrder/terms/payment/@finSurcharge) [Optional]</p>
garAttrib	<p>garment's attribute to which the measures are referred - base type: string, cod. table: NT41 http://www.moda-ml.net/moda-ml/repository/codelist/v2013-1/gc_NT41.xml (XPath: KnitClothOrder/KCCObody/KCCOitem/garTecSheet/ garMeaSet/garAttrib) 1-1</p>
garSizeCode	<p>code of a range of sizes - base type: string, max length: 15, (XPath: KnitClothOrder/KCCObody/KCCOitem/garTecSheet/ garSizeSet/garSizeTier/garSizeCode) 1-1 (XPath: KnitClothOrder/KCCObody/KCCOitem/garTecSheet/ garConsumptionSet/garConsumption/garSizeCode) 0-1</p>
gPart	<p>code specifying the type of component or part of a garment (sleeve, neck, ...) - base type: string, cod. table: T48 http://www.moda-ml.net/moda-ml/repository/codelist/v2013-1/gc_T48.xml (XPath: KnitClothOrder/KCCObody/KCCOitem/apparelComponent/gPart) 0-1 (XPath: KnitClothOrder/KCCObody/KCCOitem/apparelComponent/ garmentPartComponent/garmentPartCode/gPart) 1-1 (XPath: KnitClothOrder/KCCObody/KCCOitem/apparelProd/ garmentPartCode/gPart) 1-1</p>
grossWeight	<p>the gross weight of the overall goods supply, declared for transport or customs purpose - base type: decimal, min inclusive: 0, fraction digits: 2, (XPath: KnitClothOrder/KCCObody/KCCOitem/garTecSheet/grossWeight) 0-1</p>

	(XPath: KnitClothOrder/terms/transInfo/grossWeight) 0-1
id	<p>primary identification code of a Party; it is recommended the format: nation code (ISO 3166) + VAT identification number (11 crt), with the qualifier "numberingOrg"= MF</p> <p>- base type: string, max length: 15,</p> <p>(XPath: KnitClothOrder/KCCOheader/buyer/id) 1-1 (XPath: KnitClothOrder/KCCOheader/subContractor/id) 1-1 (XPath: KnitClothOrder/KCCOheader/thirdParty/id) 1-1 (XPath: KnitClothOrder/KCCObody/KCCOitem/thirdParty/id) 1-1</p>
image	<p>URL address of an annexed image</p> <p>- base type: string, max length: 240,</p> <p>(XPath: KnitClothOrder/KCCObody/KCCOitem/garTecSheet/image) 0-99</p>
incoTerm	<p>specification of the terms of trade (INCOTERMS)</p> <p>- base type: string, cod. table: T3</p> <p>http://www.moda-ml.net/moda-ml/repository/codelist/v2013-1/gc_T3.xml</p> <p>(XPath: KnitClothOrder/terms/trade/incoTerm) 1-1</p>
incoTermText	<p>free text specifying the terms of trade (incoterm, location)</p> <p>- base type: string, max length: 70,</p> <p>(XPath: KnitClothOrder/terms/trade/incoTermText) 1-1</p>
itemID	<p>number of the line/item of the referenced document</p> <p>- base type: string, max length: 6,</p> <p>(XPath: KnitClothOrder/KCCObody/KCCOitem/apparelComponent/acsComponent/refDoc/itemID) 0-1 (XPath: KnitClothOrder/KCCOheader/refDoc/itemID) 0-1 (XPath: KnitClothOrder/KCCObody/KCCOitem/appMnfrOperation/refDoc/itemID) 0-1 (XPath: KnitClothOrder/KCCObody/KCCOitem/garTecSheet/refDoc/itemID) 0-1 (XPath: KnitClothOrder/KCCObody/KCCOitem/apparelComponent/garmentPartComponent/refDoc/itemID) 0-1 (XPath: KnitClothOrder/KCCObody/KCCOitem/apparelComponent/fabricComponent/refDoc/itemID) 0-1 (XPath: KnitClothOrder/KCCObody/KCCOitem/apparelComponent/yarnComponent/refDoc/itemID) 0-1</p>
jobName	<p>description of the elementary job</p> <p>- base type: string, max length: 40,</p> <p>(XPath: KnitClothOrder/KCCObody/KCCOitem/appMnfrOperation/jobName) 1-1</p>
legalName	<p>legal name of a Party</p> <p>- base type: string, max length: 80,</p> <p>(XPath: KnitClothOrder/KCCOheader/buyer/legalName) 0-1 (XPath: KnitClothOrder/KCCOheader/subContractor/legalName) 0-1 (XPath: KnitClothOrder/KCCOheader/thirdParty/legalName) 0-1 (XPath: KnitClothOrder/KCCObody/KCCOitem/thirdParty/legalName) 0-1</p>
legalRef	<p>legal reference of the duty or tax or fee category</p> <p>- base type: string,</p> <p>(XPath: KnitClothOrder/terms/allowanceCharge/dtScheme/legalRef) 0-1 (XPath: KnitClothOrder/KCCObody/KCCOitem/dtScheme/legalRef) 0-1</p>
lineN	<p>number of the line item of the present message (xml document)</p> <p>- base type: positiveInteger, min inclusive: 1, max inclusive: 9999,</p> <p>(XPath: KnitClothOrder/KCCObody/KCCOitem/lineN) 1-1</p>
@listName	<p>it specifies the name of the list of codes used to make an instance of the element</p> <p>- base type: string, max length: 40,</p> <p>(XPath: KnitClothOrder/KCCObody/KCCOitem/garTecSheet/garConsumptionSet/texCode/art/@listName) [Optional]</p> <p>- nota: <i>this attribute should always be used coupled with</i></p>

“numberingOrg”
 (XPath: KnitClothOrder/KCCObody/KCCOitem/apparelProd/
 garmentCode/garmentCodeB/fabric/@listName) [Optional]
 - nota: *this attribute should always be used coupled with
 “numberingOrg”*
 (XPath: KnitClothOrder/KCCObody/KCCOitem/garTecSheet/
 garConsumptionSet/acsCode/art/@listName) [Optional]
 - nota: *this attribute should always be used coupled with
 “numberingOrg”*
 (XPath: KnitClothOrder/KCCObody/KCCOitem/apparelComponent/
 yarnComponent/yarnCode/art/@listName) [Optional]
 - nota: *this attribute should always be used coupled with
 “numberingOrg”*
 (XPath: KnitClothOrder/KCCObody/KCCOitem/apparelProd/
 garmentCode/garmentCodeB/mod/@listName) [Optional]
 - nota: *this attribute should always be used coupled with
 “numberingOrg”*
 (XPath: KnitClothOrder/KCCObody/KCCOitem/apparelComponent/
 garmentPartComponent/garmentPartCode/fabric/@listName)
 [Optional]
 - nota: *this attribute should always be used coupled with
 “numberingOrg”*
 (XPath: KnitClothOrder/KCCObody/KCCOitem/apparelComponent/
 fabricComponent/texCode/pattern/@listName) [Optional]
 - nota: *this attribute should always be used coupled with
 “numberingOrg”*
 (XPath: KnitClothOrder/KCCObody/KCCOitem/apparelComponent/
 fabricComponent/texCode/art/@listName) [Optional]
 - nota: *this attribute should always be used coupled with
 “numberingOrg”*
 (XPath: KnitClothOrder/KCCObody/KCCOitem/apparelProd/
 garmentCode/garmentCodeB/color/@listName) [Optional]
 - nota: *this attribute should always be used coupled with
 “numberingOrg”*
 (XPath: KnitClothOrder/KCCObody/KCCOitem/apparelComponent/
 acsComponent/acsCode/art/@listName) [Optional]
 - nota: *this attribute should always be used coupled with
 “numberingOrg”*
 (XPath: KnitClothOrder/KCCObody/KCCOitem/garTecSheet/
 garConsumptionSet/texCode/pattern/@listName) [Optional]
 - nota: *this attribute should always be used coupled with
 “numberingOrg”*
 (XPath: KnitClothOrder/KCCObody/KCCOitem/apparelComponent/
 acsComponent/acsCode/pattern/@listName) [Optional]
 - nota: *this attribute should always be used coupled with
 “numberingOrg”*
 (XPath: KnitClothOrder/KCCObody/KCCOitem/apparelComponent/
 acsComponent/acsCode/color/@listName) [Optional]
 - nota: *this attribute should always be used coupled with
 “numberingOrg”*
 (XPath: KnitClothOrder/KCCObody/KCCOitem/apparelProd/
 csRange/color/@listName) [Optional]
 - nota: *this attribute should always be used coupled with
 “numberingOrg”*
 (XPath: KnitClothOrder/KCCObody/KCCOitem/apparelComponent/
 garmentPartComponent/garmentPartCode/color/@listName)
 [Optional]
 - nota: *this attribute should always be used coupled with
 “numberingOrg”*
 (XPath: KnitClothOrder/KCCObody/KCCOitem/garTecSheet/
 garConsumptionSet/texCode/color/@listName) [Optional]
 - nota: *this attribute should always be used coupled with
 “numberingOrg”*

(XPath: KnitClothOrder/KCCObody/KCCOitem/garTecSheet/
garConsumptionSet/yarnCode/art/@listName) [Optional]
- nota: *this attribute should always be used coupled with
"numberingOrg"*

(XPath: KnitClothOrder/KCCObody/KCCOitem/garTecSheet/
garmentCode/garmentCodeB/fabric/@listName) [Optional]
- nota: *this attribute should always be used coupled with
"numberingOrg"*

(XPath: KnitClothOrder/KCCObody/KCCOitem/apparelProd/
garmentPartCode/fabric/@listName) [Optional]
- nota: *this attribute should always be used coupled with
"numberingOrg"*

(XPath: KnitClothOrder/KCCObody/KCCOitem/apparelComponent/
yarnComponent/yarnCode/color/@listName) [Optional]
- nota: *this attribute should always be used coupled with
"numberingOrg"*

(XPath: KnitClothOrder/KCCObody/KCCOitem/apparelProd/
garmentCode/garmentCodeA/art/@listName) [Optional]
- nota: *this attribute should always be used coupled with
"numberingOrg"*

(XPath: KnitClothOrder/KCCObody/KCCOitem/apparelProd/
garmentPartCode/mod/@listName) [Optional]
- nota: *this attribute should always be used coupled with
"numberingOrg"*

(XPath: KnitClothOrder/KCCObody/KCCOitem/garTecSheet/
garmentCode/garmentCodeB/mod/@listName) [Optional]
- nota: *this attribute should always be used coupled with
"numberingOrg"*

(XPath: KnitClothOrder/KCCObody/KCCOitem/garTecSheet/
garmentCode/garmentCodeA/art/@listName) [Optional]
- nota: *this attribute should always be used coupled with
"numberingOrg"*

(XPath: KnitClothOrder/KCCObody/KCCOitem/garTecSheet/
garConsumptionSet/acsCode/color/@listName) [Optional]
- nota: *this attribute should always be used coupled with
"numberingOrg"*

(XPath: KnitClothOrder/KCCObody/KCCOitem/apparelComponent/
fabricComponent/texCode/color/@listName) [Optional]
- nota: *this attribute should always be used coupled with
"numberingOrg"*

(XPath: KnitClothOrder/KCCObody/KCCOitem/garTecSheet/
garConsumptionSet/yarnCode/color/@listName) [Optional]
- nota: *this attribute should always be used coupled with
"numberingOrg"*

(XPath: KnitClothOrder/KCCObody/KCCOitem/garTecSheet/
garConsumptionSet/acsCode/pattern/@listName) [Optional]
- nota: *this attribute should always be used coupled with
"numberingOrg"*

(XPath: KnitClothOrder/KCCObody/KCCOitem/garTecSheet/
garmentCode/garmentCodeB/artGroup/@listName) [Optional]
- nota: *this attribute should always be used coupled with
"numberingOrg"*

(XPath: KnitClothOrder/KCCObody/KCCOitem/apparelProd/
garmentCode/garmentCodeB/artGroup/@listName) [Optional]
- nota: *this attribute should always be used coupled with
"numberingOrg"*

(XPath: KnitClothOrder/KCCObody/KCCOitem/apparelComponent/
garmentPartComponent/garmentPartCode/mod/@listName)
[Optional]
- nota: *this attribute should always be used coupled with
"numberingOrg"*

(XPath: KnitClothOrder/KCCObody/KCCOitem/apparelProd/
garmentPartCode/color/@listName) [Optional]

	<p>- nota: <i>this attribute should always be used coupled with “numberingOrg”</i> (XPath: KnitClothOrder/KCCObody/KCCOitem/garTecSheet/ garmentCode/garmentCodeB/color/@listName) [Optional]</p> <p>- nota: <i>this attribute should always be used coupled with “numberingOrg”</i></p>
@listVersion	<p>it specifie the version of the list of codes used to make an instance of the element</p> <p>- base type: string, max length: 6, (XPath: KnitClothOrder/KCCObody/KCCOitem/garTecSheet/ garConsumptionSet/texCode/art/@listVersion) [Optional]</p> <p>- nota: <i>this attribute should always be used coupled with “numberingOrg” and “listName”</i> (XPath: KnitClothOrder/KCCObody/KCCOitem/garTecSheet/ garmentCode/garmentCodeB/color/@listVersion) [Optional]</p> <p>- nota: <i>this attribute should always be used coupled with “numberingOrg” and “listName”</i> (XPath: KnitClothOrder/KCCObody/KCCOitem/apparelProd/ garmentCode/garmentCodeB/artGroup/@listVersion) [Optional]</p> <p>- nota: <i>this attribute should always be used coupled with “numberingOrg” and “listName”</i> (XPath: KnitClothOrder/KCCObody/KCCOitem/apparelComponent/ garmentPartComponent/garmentPartCode/color/@listVersion) [Optional]</p> <p>- nota: <i>this attribute should always be used coupled with “numberingOrg” and “listName”</i> (XPath: KnitClothOrder/KCCObody/KCCOitem/apparelComponent/ fabricComponent/texCode/pattern/@listVersion) [Optional]</p> <p>- nota: <i>this attribute should always be used coupled with “numberingOrg” and “listName”</i> (XPath: KnitClothOrder/KCCObody/KCCOitem/apparelProd/ garmentPartCode/color/@listVersion) [Optional]</p> <p>- nota: <i>this attribute should always be used coupled with “numberingOrg” and “listName”</i> (XPath: KnitClothOrder/KCCObody/KCCOitem/garTecSheet/ garConsumptionSet/yarnCode/art/@listVersion) [Optional]</p> <p>- nota: <i>this attribute should always be used coupled with “numberingOrg” and “listName”</i> (XPath: KnitClothOrder/KCCObody/KCCOitem/garTecSheet/ garConsumptionSet/yarnCode/color/@listVersion) [Optional]</p> <p>- nota: <i>this attribute should always be used coupled with “numberingOrg” and “listName”</i> (XPath: KnitClothOrder/KCCObody/KCCOitem/apparelProd/ garmentPartCode/fabric/@listVersion) [Optional]</p> <p>- nota: <i>this attribute should always be used coupled with “numberingOrg” and “listName”</i> (XPath: KnitClothOrder/KCCObody/KCCOitem/apparelProd/ garmentPartCode/mod/@listVersion) [Optional]</p> <p>- nota: <i>this attribute should always be used coupled with “numberingOrg” and “listName”</i> (XPath: KnitClothOrder/KCCObody/KCCOitem/garTecSheet/ garmentCode/garmentCodeB/fabric/@listVersion) [Optional]</p> <p>- nota: <i>this attribute should always be used coupled with “numberingOrg” and “listName”</i> (XPath: KnitClothOrder/KCCObody/KCCOitem/apparelComponent/ fabricComponent/texCode/color/@listVersion) [Optional]</p> <p>- nota: <i>this attribute should always be used coupled with “numberingOrg” and “listName”</i> (XPath: KnitClothOrder/KCCObody/KCCOitem/apparelComponent/ yarnComponent/yarnCode/art/@listVersion) [Optional]</p> <p>- nota: <i>this attribute should always be used coupled with “numberingOrg” and “listName”</i></p>

(XPath: KnitClothOrder/KCCObody/KCCOitem/garTecSheet/garConsumptionSet/texCode/color/@listVersion) [Optional]
- nota: *this attribute should always be used coupled with "numberingOrg" and "listName"*

(XPath: KnitClothOrder/KCCObody/KCCOitem/apparelProd/garmentCode/garmentCodeB/color/@listVersion) [Optional]
- nota: *this attribute should always be used coupled with "numberingOrg" and "listName"*

(XPath: KnitClothOrder/KCCObody/KCCOitem/garTecSheet/garConsumptionSet/texCode/pattern/@listVersion) [Optional]
- nota: *this attribute should always be used coupled with "numberingOrg" and "listName"*

(XPath: KnitClothOrder/KCCObody/KCCOitem/apparelProd/garmentCode/garmentCodeB/mod/@listVersion) [Optional]
- nota: *this attribute should always be used coupled with "numberingOrg" and "listName"*

(XPath: KnitClothOrder/KCCObody/KCCOitem/apparelComponent/garmentPartComponent/garmentPartCode/mod/@listVersion) [Optional]
- nota: *this attribute should always be used coupled with "numberingOrg" and "listName"*

(XPath: KnitClothOrder/KCCObody/KCCOitem/apparelProd/garmentCode/garmentCodeB/fabric/@listVersion) [Optional]
- nota: *this attribute should always be used coupled with "numberingOrg" and "listName"*

(XPath: KnitClothOrder/KCCObody/KCCOitem/apparelComponent/garmentPartComponent/garmentPartCode/fabric/@listVersion) [Optional]
- nota: *this attribute should always be used coupled with "numberingOrg" and "listName"*

(XPath: KnitClothOrder/KCCObody/KCCOitem/garTecSheet/garConsumptionSet/acsCode/color/@listVersion) [Optional]
- nota: *this attribute should always be used coupled with "numberingOrg" and "listName"*

(XPath: KnitClothOrder/KCCObody/KCCOitem/apparelComponent/acsComponent/acsCode/art/@listVersion) [Optional]
- nota: *this attribute should always be used coupled with "numberingOrg" and "listName"*

(XPath: KnitClothOrder/KCCObody/KCCOitem/garTecSheet/garmentCode/garmentCodeA/art/@listVersion) [Optional]
- nota: *this attribute should always be used coupled with "numberingOrg" and "listName"*

(XPath: KnitClothOrder/KCCObody/KCCOitem/apparelComponent/yarnComponent/yarnCode/color/@listVersion) [Optional]
- nota: *this attribute should always be used coupled with "numberingOrg" and "listName"*

(XPath: KnitClothOrder/KCCObody/KCCOitem/apparelComponent/fabricComponent/texCode/art/@listVersion) [Optional]
- nota: *this attribute should always be used coupled with "numberingOrg" and "listName"*

(XPath: KnitClothOrder/KCCObody/KCCOitem/apparelComponent/acsComponent/acsCode/pattern/@listVersion) [Optional]
- nota: *this attribute should always be used coupled with "numberingOrg" and "listName"*

(XPath: KnitClothOrder/KCCObody/KCCOitem/apparelProd/csRange/color/@listVersion) [Optional]
- nota: *this attribute should always be used coupled with "numberingOrg" and "listName"*

(XPath: KnitClothOrder/KCCObody/KCCOitem/garTecSheet/garmentCode/garmentCodeB/artGroup/@listVersion) [Optional]
- nota: *this attribute should always be used coupled with "numberingOrg" and "listName"*

(XPath: KnitClothOrder/KCCObody/KCCOitem/apparelComponent/

	<p>acsComponent/acsCode/color/@listVersion) [Optional] - nota: <i>this attribute should always be used coupled with "numberingOrg" and "listName"</i> (XPath: KnitClothOrder/KCCObody/KCCOitem/garTecSheet/garmentCode/garmentCodeB/mod/@listVersion) [Optional] - nota: <i>this attribute should always be used coupled with "numberingOrg" and "listName"</i> (XPath: KnitClothOrder/KCCObody/KCCOitem/garTecSheet/garConsumptionSet/acsCode/pattern/@listVersion) [Optional] - nota: <i>this attribute should always be used coupled with "numberingOrg" and "listName"</i> (XPath: KnitClothOrder/KCCObody/KCCOitem/apparelProd/garmentCode/garmentCodeA/art/@listVersion) [Optional] - nota: <i>this attribute should always be used coupled with "numberingOrg" and "listName"</i> (XPath: KnitClothOrder/KCCObody/KCCOitem/garTecSheet/garConsumptionSet/acsCode/art/@listVersion) [Optional] - nota: <i>this attribute should always be used coupled with "numberingOrg" and "listName"</i></p>
location	<p>specification of a location - base type: string, max length: 40, (XPath: KnitClothOrder/KCCObody/KCCOitem/apparelComponent/acsComponent/location) 0-1 (XPath: KnitClothOrder/KCCObody/KCCOitem/apparelComponent/yarnComponent/location) 0-1 - note: <i>here the storage place of the component can be specified</i> (XPath: KnitClothOrder/terms/trade/location) 0-1 - note: <i>place to which the INCOTERM applies</i> (XPath: KnitClothOrder/KCCObody/KCCOitem/apparelComponent/fabricComponent/location) 0-1 - note: <i>it may be used to specify the location where lie the pieces that the Subcontractor must use for the commisioned work operation</i> (XPath: KnitClothOrder/KCCObody/KCCOitem/apparelComponent/garmentPartComponent/location) 0-1</p>
@logo	<p>company logo (URL of the image jpeg or gif). It is recommended that the width of the image does not exceed 640 pixel. - base type: string, max length: 255, (XPath: KnitClothOrder/KCCOheader/buyer/@logo) [Optional]</p>
lotN	<p>lot number of a product or batch number of the raw material - base type: string, max length: 15, (XPath: KnitClothOrder/KCCObody/KCCOitem/apparelProd/lotN) 0-1 (XPath: KnitClothOrder/KCCObody/KCCOitem/apparelComponent/acsComponent/lotN) 0-1 (XPath: KnitClothOrder/KCCObody/KCCOitem/apparelComponent/garmentPartComponent/lotN) 0-1 (XPath: KnitClothOrder/KCCObody/KCCOitem/apparelComponent/yarnComponent/lotN) 0-1</p>
@LRI	<p>attribute usable to format a string according to a customized User rule (local rule) - base type: string, cod. table: NT3 http://www.moda-ml.net/moda-ml/repository/codelist/v2013-1/gc_NT3.xml (XPath: KnitClothOrder/KCCObody/KCCOitem/apparelComponent/acsComponent/location/@LRI) [Optional] (XPath: KnitClothOrder/KCCObody/KCCOitem/apparelComponent/fabricComponent/location/@LRI) [Optional] (XPath: KnitClothOrder/terms/trade/location/@LRI) [Optional] (XPath: KnitClothOrder/KCCObody/KCCOitem/apparelComponent/yarnComponent/location/@LRI) [Optional] (XPath: KnitClothOrder/KCCObody/KCCOitem/apparelComponent/</p>

	garmentPartComponent/location/@LRI [Optional]
@method	standard protocol or method employed in a test to evaluate a characteristic or a parameter - base type: string, max length: 25, (XPath: KnitClothOrder/KCCObody/KCCOitem/garTecSheet/garMeaSet/garMea/specValue/@method) [Optional]
mfrStatus	code of the manufacturing stage used to describe the progress in the production cycle - base type: string, cod. table: T7 http://www.moda-ml.net/moda-ml/repository/codelist/v2013-1/gc_T7.xml (XPath: KnitClothOrder/KCCObody/KCCOitem/progress/mfrStatus) 0-1
mfrStatusText	free text description of the manufacturing stage used to specify the progress in the production cycle - base type: string, max length: 40, (XPath: KnitClothOrder/KCCObody/KCCOitem/progress/mfrStatusText) 0-1
mnfrNote	free text manufacturing note - base type: string, max length: 350, (XPath: KnitClothOrder/KCCObody/KCCOitem/garTecSheet/mnfrNote) 0-99
mod	model number of the garment - base type: string, max length: 15, (XPath: KnitClothOrder/KCCObody/KCCOitem/apparelProd/garmentPartCode/mod) 1-1 - note: <i>when a garment component, it should be the code assigned to the garment article</i> (XPath: KnitClothOrder/KCCObody/KCCOitem/garTecSheet/garmentCode/garmentCodeB/mod) 1-1 (XPath: KnitClothOrder/KCCObody/KCCOitem/apparelComponent/garmentPartComponent/garmentPartCode/mod) 1-1 - note: <i>when a garment component, it should be the code assigned to the garment article</i> (XPath: KnitClothOrder/KCCObody/KCCOitem/apparelProd/garmentCode/garmentCodeB/mod) 1-1
msgCurrency	currency used to express the monetary amounts of the message - base type: string, cod. table: T9 http://www.moda-ml.net/moda-ml/repository/codelist/v2013-1/gc_T9.xml (XPath: KnitClothOrder/KCCOheader/msgCurrency) 0-1
msgDate	date of issue of the present message (xml document), according to one of the patterns YYYY-MM-DD, YYYY-MM-DD:HH-MM or YYYY-WW. - base type: string, (XPath: KnitClothOrder/KCCOheader/msgDate) 1-1
@msgfunction	function performed by the present message with regards to the transmission - base type: string, cod. table: NT18 http://www.moda-ml.net/moda-ml/repository/codelist/v2013-1/gc_NT18.xml (XPath: KnitClothOrder/@msgfunction) [Optional] [Default= OR]
msgID	key identifier of the document in the information system of the issuing Party - base type: string, max length: 35, (XPath: KnitClothOrder/KCCOheader/msgID) 0-1
msgN	identification number given to the message (xml document) by its issuer - base type: string, max length: 35, (XPath: KnitClothOrder/KCCOheader/msgN) 1-1

netWeight	<p>the net weight of the overall goods supply, declared for transport or customs purpose</p> <ul style="list-style-type: none"> - base type: decimal, min inclusive: 0, fraction digits: 2, <p>(XPath: KnitClothOrder/KCCObody/KCCOitem/garTecSheet/netWeight) 0-1</p> <p>(XPath: KnitClothOrder/terms/transInfo/netWeight) 0-1</p>
note	<p>free text or structured (computer processing) note. For note structuring use the attributes "noteLabel" and "codelist"</p> <ul style="list-style-type: none"> - base type: string, max length: 350, <p>(XPath: KnitClothOrder/terms/allowanceCharge/dtScheme/note) 0-19</p> <p>(XPath: KnitClothOrder/KCCOheader/note) 0-19</p> <p>(XPath: KnitClothOrder/KCCObody/KCCOitem/apparelComponent/yarnComponent/note) 0-19</p> <p>(XPath: KnitClothOrder/KCCObody/KCCOitem/apparelProd/note) 0-19</p> <p>(XPath: KnitClothOrder/KCCObody/KCCOitem/dtScheme/note) 0-19</p> <p>(XPath: KnitClothOrder/KCCObody/KCCOitem/apparelComponent/garmentPartComponent/note) 0-19</p> <p>(XPath: KnitClothOrder/KCCObody/KCCOitem/appMnfrOperation/note) 0-19</p> <p>(XPath: KnitClothOrder/KCCObody/KCCOitem/apparelComponent/fabricComponent/note) 0-19</p> <p>(XPath: KnitClothOrder/KCCObody/KCCOitem/apparelComponent/acsComponent/note) 0-19</p>
@noteLabel	<p>subject qualifier of a note</p> <ul style="list-style-type: none"> - base type: string, max length: 35, <p>(XPath: KnitClothOrder/KCCObody/KCCOitem/appMnfrOperation/note/@noteLabel) [Optional]</p> <ul style="list-style-type: none"> - nota: <i>must be used to qualify the subject of the note</i> <p>(XPath: KnitClothOrder/KCCObody/KCCOitem/apparelComponent/garmentPartComponent/note/@noteLabel) [Optional]</p> <ul style="list-style-type: none"> - nota: <i>must be used to qualify the subject of the note</i> <p>(XPath: KnitClothOrder/KCCObody/KCCOitem/dtScheme/note/@noteLabel) [Optional]</p> <ul style="list-style-type: none"> - nota: <i>must be used to qualify the subject of the note</i> <p>(XPath: KnitClothOrder/KCCObody/KCCOitem/apparelComponent/fabricComponent/note/@noteLabel) [Optional]</p> <ul style="list-style-type: none"> - nota: <i>must be used to qualify the subject of the note</i> <p>(XPath: KnitClothOrder/KCCOheader/note/@noteLabel) [Optional]</p> <ul style="list-style-type: none"> - nota: <i>must be used to qualify the subject of the note</i> <p>(XPath: KnitClothOrder/terms/allowanceCharge/dtScheme/note/@noteLabel) [Optional]</p> <ul style="list-style-type: none"> - nota: <i>must be used to qualify the subject of the note</i> <p>(XPath: KnitClothOrder/KCCObody/KCCOitem/apparelComponent/yarnComponent/note/@noteLabel) [Optional]</p> <ul style="list-style-type: none"> - nota: <i>must be used to qualify the subject of the note</i> <p>(XPath: KnitClothOrder/KCCObody/KCCOitem/apparelComponent/acsComponent/note/@noteLabel) [Optional]</p> <ul style="list-style-type: none"> - nota: <i>must be used to qualify the subject of the note</i> <p>(XPath: KnitClothOrder/KCCObody/KCCOitem/apparelProd/note/@noteLabel) [Optional]</p> <ul style="list-style-type: none"> - nota: <i>must be used to qualify the subject of the note</i>
@numberingOrg	<p>code specifying the organisation who has created or owns the coding or numbering system</p> <ul style="list-style-type: none"> - base type: string, cod. table: NT6 <p>http://www.moda-ml.net/moda-ml/repository/codelist/v2013-1/gc_NT6.xml</p> <p>(XPath: KnitClothOrder/KCCObody/KCCOitem/apparelComponent/fabricComponent/texCode/pattern/@numberingOrg) [Optional]</p> <ul style="list-style-type: none"> - nota: <i>this attribute should be used either single or coupled with "listName" and "listVersion"</i>

(XPath: KnitClothOrder/KCCObody/KCCOitem/apparelComponent/fabricComponent/texCode/@numberingOrg) [Optional]

(XPath: KnitClothOrder/KCCObody/KCCOitem/apparelComponent/fabricComponent/texCode/color/@numberingOrg) [Optional]

- nota: *this attribute should be used either single or coupled with "listName" and "listVersion"*

(XPath: KnitClothOrder/KCCObody/KCCOitem/apparelComponent/yarnComponent/note/@numberingOrg) [Optional]

(XPath: KnitClothOrder/KCCObody/KCCOitem/apparelComponent/fabricComponent/texCode/art/@numberingOrg) [Optional]

- nota: *this attribute should be used either single or coupled with "listName" and "listVersion"*

(XPath: KnitClothOrder/KCCObody/KCCOitem/apparelComponent/acsComponent/acsCode/color/@numberingOrg) [Optional]

- nota: *this attribute should be used either single or coupled with "listName" and "listVersion"*

(XPath: KnitClothOrder/KCCObody/KCCOitem/apparelComponent/acsComponent/acsCode/added/@numberingOrg) [Optional]

(XPath: KnitClothOrder/KCCObody/KCCOitem/apparelComponent/acsComponent/lotN/@numberingOrg) [Optional]

(XPath: KnitClothOrder/KCCOheader/subContractor/id/@numberingOrg) [Optional]

(XPath: KnitClothOrder/KCCObody/KCCOitem/apparelComponent/acsComponent/acsCode/@numberingOrg) [Optional]

(XPath: KnitClothOrder/KCCObody/KCCOitem/apparelComponent/acsComponent/acsCode/art/@numberingOrg) [Optional]

- nota: *this attribute should be used either single or coupled with "listName" and "listVersion"*

(XPath: KnitClothOrder/KCCObody/KCCOitem/apparelComponent/acsComponent/acsCode/pattern/@numberingOrg) [Optional]

- nota: *this attribute should be used either single or coupled with "listName" and "listVersion"*

(XPath: KnitClothOrder/KCCObody/KCCOitem/apparelComponent/acsComponent/dyeN/@numberingOrg) [Optional]

(XPath: KnitClothOrder/KCCOheader/docID/@numberingOrg) [Optional]

- nota: *here can be specified whose document numbering is used (e.g.: Client, Supplier, ..)*

(XPath: KnitClothOrder/KCCOheader/refDoc/docID/@numberingOrg) [Optional]

- nota: *here can be specified whose document numbering is used (e.g.: Client, Supplier, ..)*

(XPath: KnitClothOrder/KCCObody/KCCOitem/appMnfrOperation/refDoc/docID/@numberingOrg) [Optional]

- nota: *here can be specified whose document numbering is used (e.g.: Client, Supplier, ..)*

(XPath: KnitClothOrder/KCCObody/KCCOitem/apparelComponent/acsComponent/note/@numberingOrg) [Optional]

(XPath: KnitClothOrder/KCCObody/KCCOitem/appMnfrOperation/note/@numberingOrg) [Optional]

(XPath: KnitClothOrder/KCCObody/KCCOitem/apparelComponent/acsComponent/refDoc/docID/@numberingOrg) [Optional]

- nota: *here can be specified whose document numbering is used (e.g.: Client, Supplier, ..)*

(XPath: KnitClothOrder/KCCOheader/buyer/id/@numberingOrg) [Optional]

(XPath: KnitClothOrder/KCCObody/KCCOitem/apparelComponent/fabricComponent/note/@numberingOrg) [Optional]

(XPath: KnitClothOrder/KCCObody/KCCOitem/apparelComponent/garmentPartComponent/garmentPartCode/@numberingOrg) [Optional]

(XPath: KnitClothOrder/KCCObody/KCCOitem/apparelComponent/garmentPartComponent/garmentPartCode/mod/@numberingOrg) [Optional]

- nota: *this attribute should be ALTERNATIVE to the others*

(XPath:

KnitClothOrder/KCCObody/KCCOitem/dtScheme/note/@numberingOrg) [Optional]
 (XPath: KnitClothOrder/KCCObody/KCCOitem/apparelComponent/fabricComponent/texCode/added/@numberingOrg) [Optional]
 (XPath: KnitClothOrder/KCCObody/KCCOitem/apparelComponent/fabricComponent/serialN/@numberingOrg) [Optional]
 - nota: *here the issuer of the serial number must be specified (when different from the Supplier)*
 (XPath: KnitClothOrder/KCCObody/KCCOitem/apparelComponent/fabricComponent/refDoc/docID/@numberingOrg) [Optional]
 - nota: *here can be specified whose document numbering is used (e.g.: Client, Supplier, ..)*
 (XPath: KnitClothOrder/KCCOheader/note/@numberingOrg) [Optional]
 (XPath: KnitClothOrder/KCCOheader/thirdParty/id/@numberingOrg) [Optional]
 (XPath: KnitClothOrder/KCCObody/KCCOitem/apparelComponent/garmentPartComponent/refDoc/docID/@numberingOrg) [Optional]
 - nota: *here can be specified whose document numbering is used (e.g.: Client, Supplier, ..)*
 (XPath: KnitClothOrder/KCCObody/KCCOitem/apparelComponent/garmentPartComponent/note/@numberingOrg) [Optional]
 (XPath: KnitClothOrder/KCCObody/KCCOitem/apparelComponent/garmentPartComponent/dyeN/@numberingOrg) [Optional]
 (XPath: KnitClothOrder/KCCObody/KCCOitem/apparelComponent/garmentPartComponent/garmentPartCode/fabric/@numberingOrg) [Optional]
 - nota: *this attribute should be used either single or coupled with "listName" and "listVersion"*
 (XPath: KnitClothOrder/KCCObody/KCCOitem/apparelComponent/garmentPartComponent/garmentPartCode/color/@numberingOrg) [Optional]
 - nota: *this attribute should be used either single or coupled with "listName" and "listVersion"*
 (XPath: KnitClothOrder/KCCObody/KCCOitem/apparelComponent/garmentPartComponent/lotN/@numberingOrg) [Optional]
 (XPath: KnitClothOrder/KCCObody/KCCOitem/garTecSheet/garConsumptionSet/texCode/pattern/@numberingOrg) [Optional]
 - nota: *this attribute should be used either single or coupled with "listName" and "listVersion"*
 (XPath: KnitClothOrder/KCCObody/KCCOitem/garTecSheet/garConsumptionSet/texCode/art/@numberingOrg) [Optional]
 - nota: *this attribute should be used either single or coupled with "listName" and "listVersion"*
 (XPath: KnitClothOrder/KCCObody/KCCOitem/garTecSheet/garConsumptionSet/texCode/color/@numberingOrg) [Optional]
 - nota: *this attribute should be used either single or coupled with "listName" and "listVersion"*
 (XPath: KnitClothOrder/KCCObody/KCCOitem/garTecSheet/garConsumptionSet/texCode/added/@numberingOrg) [Optional]
 (XPath: KnitClothOrder/KCCObody/KCCOitem/apparelProd/garmentCode/garmentCodeB/color/@numberingOrg) [Optional]
 - nota: *this attribute should be used either single or coupled with "listName" and "listVersion"*
 (XPath: KnitClothOrder/KCCObody/KCCOitem/garTecSheet/garConsumptionSet/acsCode/added/@numberingOrg) [Optional]
 (XPath: KnitClothOrder/KCCObody/KCCOitem/apparelProd/garmentCode/garmentCodeA/art/@numberingOrg) [Optional]
 - nota: *this attribute should be used either single or coupled with "listName" and "listVersion"*
 (XPath: KnitClothOrder/KCCObody/KCCOitem/apparelProd/garmentCode/garmentCodeB/added/@numberingOrg) [Optional]
 (XPath: KnitClothOrder/KCCObody/KCCOitem/apparelProd/garmentCode/garmentCodeB/artGroup/@numberingOrg) [Optional]

- nota: *this attribute should be used either single or coupled with "listName" and "listVersion"*
(XPath: KnitClothOrder/KCCObody/KCCOitem/garTecSheet/
garConsumptionSet/texCode/@numberingOrg) [Optional]
(XPath: KnitClothOrder/KCCObody/KCCOitem/apparelProd/
garmentCode/@numberingOrg) [Optional]
(XPath: KnitClothOrder/KCCObody/KCCOitem/apparelProd/
garmentCode/garmentCodeB/@numberingOrg) [Optional]
(XPath: KnitClothOrder/KCCObody/KCCOitem/garTecSheet/
garConsumptionSet/yarnCode/added/@numberingOrg) [Optional]
(XPath: KnitClothOrder/KCCObody/KCCOitem/apparelProd/
garmentPartCode/color/@numberingOrg) [Optional]

- nota: *this attribute should be used either single or coupled with "listName" and "listVersion"*
(XPath: KnitClothOrder/KCCObody/KCCOitem/garTecSheet/
garConsumptionSet/garConsumption/@numberingOrg) [Optional]
(XPath: KnitClothOrder/KCCObody/KCCOitem/garTecSheet/
garConsumptionSet/yarnCode/@numberingOrg) [Optional]
[Default= CL]
(XPath: KnitClothOrder/KCCObody/KCCOitem/apparelProd/
garmentCode/garmentCodeB/fabric/@numberingOrg) [Optional]

- nota: *this attribute should be used either single or coupled with "listName" and "listVersion"*
(XPath: KnitClothOrder/KCCObody/KCCOitem/garTecSheet/
garConsumptionSet/yarnCode/art/@numberingOrg) [Optional]

- nota: *this attribute should be used either single or coupled with "listName" and "listVersion"*
(XPath: KnitClothOrder/KCCObody/KCCOitem/garTecSheet/
garConsumptionSet/yarnCode/color/@numberingOrg) [Optional]

- nota: *this attribute should be used either single or coupled with "listName" and "listVersion"*
(XPath: KnitClothOrder/KCCObody/KCCOitem/apparelProd/
garmentCode/garmentCodeB/mod/@numberingOrg) [Optional]

- nota: *this attribute should be ALTERNATIVE to the others*
(XPath: KnitClothOrder/KCCObody/KCCOitem/garTecSheet/
garmentCode/garmentCodeB/added/@numberingOrg) [Optional]
(XPath: KnitClothOrder/KCCObody/KCCOitem/garTecSheet/
garmentCode/garmentCodeB/artGroup/@numberingOrg)
[Optional]

- nota: *this attribute should be used either single or coupled with "listName" and "listVersion"*
(XPath:
KnitClothOrder/KCCObody/KCCOitem/thirdParty/id/@numberingOrg)
[Optional]
(XPath: KnitClothOrder/KCCObody/KCCOitem/garTecSheet/
refDoc/docID/@numberingOrg) [Optional]

- nota: *here can be specified whose document numbering is used (e.g.: Client, Supplier, ..)*
(XPath: KnitClothOrder/KCCObody/KCCOitem/garTecSheet/
garmentCode/garmentCodeA/art/@numberingOrg) [Optional]

- nota: *this attribute should be used either single or coupled with "listName" and "listVersion"*
(XPath: KnitClothOrder/KCCObody/KCCOitem/garTecSheet/
garmentCode/garmentCodeB/fabric/@numberingOrg) [Optional]

- nota: *this attribute should be used either single or coupled with "listName" and "listVersion"*
(XPath: KnitClothOrder/KCCObody/KCCOitem/garTecSheet/
garmentCode/garmentCodeB/mod/@numberingOrg) [Optional]

- nota: *this attribute should be ALTERNATIVE to the others*
(XPath: KnitClothOrder/KCCObody/KCCOitem/garTecSheet/
garmentCode/garmentCodeB/@numberingOrg) [Optional]
(XPath: KnitClothOrder/KCCObody/KCCOitem/garTecSheet/
garmentCode/@numberingOrg) [Optional]

(XPath: KnitClothOrder/KCCObody/KCCOitem/garTecSheet/
garmentCode/garmentCodeB/color/@numberingOrg) [Optional]
- nota: *this attribute should be used either single or coupled with
“listName” and “listVersion”*

(XPath: KnitClothOrder/KCCObody/KCCOitem/garTecSheet/
garConsumptionSet/acsCode/art/@numberingOrg) [Optional]
- nota: *this attribute should be used either single or coupled with
“listName” and “listVersion”*

(XPath:
KnitClothOrder/KCCObody/KCCOitem/apparelProd/dyeN/@numberingOrg)
[Optional]

(XPath:
KnitClothOrder/KCCObody/KCCOitem/apparelProd/lotN/@numberingOrg)
[Optional]

(XPath: KnitClothOrder/KCCObody/KCCOitem/garTecSheet/
garConsumptionSet/acsCode/color/@numberingOrg) [Optional]
- nota: *this attribute should be used either single or coupled with
“listName” and “listVersion”*

(XPath: KnitClothOrder/KCCObody/KCCOitem/garTecSheet/
garConsumptionSet/acsCode/pattern/@numberingOrg) [Optional]
- nota: *this attribute should be used either single or coupled with
“listName” and “listVersion”*

(XPath: KnitClothOrder/KCCObody/KCCOitem/garTecSheet/
garSizeSet/@numberingOrg) [Optional]

(XPath:
KnitClothOrder/KCCObody/KCCOitem/apparelProd/note/@numberingOrg)
[Optional]

(XPath: KnitClothOrder/KCCObody/KCCOitem/apparelProd/
csRange/color/@numberingOrg) [Optional]
- nota: *this attribute should be used either single or coupled with
“listName” and “listVersion”*

(XPath: KnitClothOrder/KCCObody/KCCOitem/garTecSheet/
garConsumptionSet/acsCode/@numberingOrg) [Optional]

(XPath: KnitClothOrder/KCCObody/KCCOitem/apparelProd/
csRange/@numberingOrg) [Optional]

(XPath: KnitClothOrder/KCCObody/KCCOitem/apparelProd/
garmentPartCode/@numberingOrg) [Optional]

(XPath: KnitClothOrder/KCCObody/KCCOitem/apparelComponent/
yarnComponent/yarnCode/@numberingOrg) [Optional] [Default=
CL]

(XPath: KnitClothOrder/KCCObody/KCCOitem/apparelProd/
garmentPartCode/mod/@numberingOrg) [Optional]
- nota: *this attribute should be ALTERNATIVE to the others*

(XPath: KnitClothOrder/KCCObody/KCCOitem/apparelComponent/
yarnComponent/refDoc/docID/@numberingOrg) [Optional]
- nota: *here can be specified whose document numbering is used
(e.g.: Client, Supplier, ..)*

(XPath: KnitClothOrder/KCCObody/KCCOitem/apparelProd/
garmentPartCode/fabric/@numberingOrg) [Optional]
- nota: *this attribute should be used either single or coupled with
“listName” and “listVersion”*

(XPath: KnitClothOrder/KCCObody/KCCOitem/apparelComponent/
yarnComponent/yarnCode/art/@numberingOrg) [Optional]
- nota: *this attribute should be used either single or coupled with
“listName” and “listVersion”*

(XPath: KnitClothOrder/KCCObody/KCCOitem/apparelComponent/
yarnComponent/lotN/@numberingOrg) [Optional]

(XPath: KnitClothOrder/KCCObody/KCCOitem/apparelComponent/
yarnComponent/dyeN/@numberingOrg) [Optional]

(XPath: KnitClothOrder/KCCObody/KCCOitem/apparelComponent/
yarnComponent/yarnCode/added/@numberingOrg) [Optional]

(XPath: KnitClothOrder/KCCObody/KCCOitem/apparelComponent/
yarnComponent/yarnCode/color/@numberingOrg) [Optional]
- nota: *this attribute should be used either single or coupled with*

	<p><i>"listName" and "listVersion"</i></p> <p>(XPath: KnitClothOrder/terms/allowanceCharge/dtScheme/note/@numberingOrg) [Optional]</p>
@part	<p>percent fraction of a total payment</p> <p>- base type: decimal, min inclusive: 1, max inclusive: 99, fraction digits: 2,</p> <p>(XPath: KnitClothOrder/terms/insPayment/@part) [Required]</p> <p>- nota: <i>here the % value of each installment must be indicated</i></p>
pattern	<p>pattern/design number of the product, when not included in the article code</p> <p>- base type: string, max length: 15,</p> <p>(XPath: KnitClothOrder/KCCObody/KCCOitem/apparelComponent/acsComponent/acsCode/pattern) 0-1</p> <p>(XPath: KnitClothOrder/KCCObody/KCCOitem/garTecSheet/garConsumptionSet/texCode/pattern) 0-1</p> <p>(XPath: KnitClothOrder/KCCObody/KCCOitem/apparelComponent/fabricComponent/texCode/pattern) 0-1</p> <p>(XPath: KnitClothOrder/KCCObody/KCCOitem/garTecSheet/garConsumptionSet/acsCode/pattern) 0-1</p>
payMode	<p>way or means of payment</p> <p>- base type: string, cod. table: T2</p> <p>http://www.moda-ml.net/moda-ml/repository/codelist/v2013-1/gc_T2.xml</p> <p>(XPath: KnitClothOrder/terms/payment/payMode) 0-1</p> <p>(XPath: KnitClothOrder/terms/insPayment/payMode) 0-1</p>
payTerm	<p>code specifying the terms or time by which the payment must be done</p> <p>- base type: string, cod. table: T1</p> <p>http://www.moda-ml.net/moda-ml/repository/codelist/v2013-1/gc_T1.xml</p> <p>(XPath: KnitClothOrder/terms/insPayment/payTerm) 1-1</p> <p>(XPath: KnitClothOrder/terms/payment/payTerm) 1-1</p>
payTermText	<p>free text specifying the terms by which the payment must be done (time/mode or means)</p> <p>- base type: string, max length: 40,</p> <p>(XPath: KnitClothOrder/terms/payment/payTermText) 1-1</p> <p>(XPath: KnitClothOrder/terms/insPayment/payTermText) 1-1</p>
pcQty	<p>percent quantity of a raw material or of a specified component in a fabric or in a yarn</p> <p>- base type: decimal, min inclusive: 0, max inclusive: 100, fraction digits: 2,</p> <p>(XPath: KnitClothOrder/KCCObody/KCCOitem/apparelComponent/yarnComponent/pcQty) 0-1</p> <p>- note: <i>percentage of the component in the end product</i></p>
percCompos	<p>fiber rate in the product composition</p> <p>- base type: decimal, min inclusive: 0, max inclusive: 100, fraction digits: 2,</p> <p>(XPath: KnitClothOrder/KCCObody/KCCOitem/garTecSheet/fabricCompos/percCompos) 1-9</p>
person	<p>name of the contact person within a Party</p> <p>- base type: string, max length: 40,</p> <p>(XPath: KnitClothOrder/KCCObody/KCCOitem/thirdParty/person) 0-1</p> <p>(XPath: KnitClothOrder/KCCOheader/subContractor/person) 0-1</p> <p>(XPath: KnitClothOrder/KCCOheader/thirdParty/person) 0-1</p> <p>(XPath: KnitClothOrder/KCCOheader/buyer/person) 0-1</p>
@phone	<p>phone number of the contact person within a Party</p> <p>- base type: string, max length: 35,</p> <p>(XPath: KnitClothOrder/KCCOheader/thirdParty/person/@phone) [Optional]</p>

	<p>(XPath: KnitClothOrder/KCCOheader/subContractor/person/@phone) [Optional]</p> <p>(XPath: KnitClothOrder/KCCObody/KCCOitem/thirdParty/person/@phone) [Optional]</p> <p>(XPath: KnitClothOrder/KCCOheader/buyer/person/@phone) [Optional]</p>
postCode	<p>code defining the postal zone</p> <p>- base type: string, max length: 10,</p> <p>(XPath: KnitClothOrder/KCCOheader/buyer/postCode) 0-1</p> <p>(XPath: KnitClothOrder/KCCOheader/subContractor/postCode) 0-1</p> <p>(XPath: KnitClothOrder/KCCObody/KCCOitem/thirdParty/postCode) 0-1</p> <p>(XPath: KnitClothOrder/KCCOheader/thirdParty/postCode) 0-1</p>
price	<p>unit price of the article, object or service specified</p> <p>- base type: decimal, min inclusive: 0, fraction digits: 2,</p> <p>(XPath: KnitClothOrder/KCCObody/KCCOitem/price) 0-1</p>
@priceQualifier	<p>type of price with reference to discount and taxes</p> <p>- base type: string, cod. table: NT20</p> <p>http://www.moda-ml.net/moda-ml/repository/codelist/v2013-1/gc_NT20.xml</p> <p>(XPath: KnitClothOrder/KCCObody/KCCOitem/price/@priceQualifier) [Optional] [Default= NET]</p>
@productLevel	<p>level of the product (end or intermediate) yielded by an operation in a work cycle</p> <p>- base type: string, cod. table: NT22</p> <p>http://www.moda-ml.net/moda-ml/repository/codelist/v2013-1/gc_NT22.xml</p> <p>(XPath: KnitClothOrder/KCCObody/KCCOitem/@productLevel) [Optional] [Default= END]</p> <p>- nota: <i>the qualifier "intermediate" must be used when the product is also a component in an other line of the same Commission Order</i></p>
qty	<p>net quantity of the article or object correlated, qualified by the function of the document (ordering, delivering, ..) and by the context</p> <p>- base type: decimal, min inclusive: 0, fraction digits: 2,</p> <p>(XPath: KnitClothOrder/KCCObody/KCCOitem/apparelComponent/fabricComponent/qty) 1-3</p> <p>- note: <i>here is the code of the component used in the yarn manufacturing operation</i></p> <p>(XPath: KnitClothOrder/KCCObody/KCCOitem/apparelProd/csRange/sizeMatrix/sizeRow/qty) 0-1</p> <p>(XPath: KnitClothOrder/KCCObody/KCCOitem/garTecSheet/garConsumptionSet/garConsumption/qty) 1-1</p> <p>- note: <i>here is the provisional consumption</i></p> <p>(XPath: KnitClothOrder/KCCObody/KCCOitem/apparelComponent/garmentPartComponent/qty) 1-2</p> <p>(XPath: KnitClothOrder/KCCObody/KCCOitem/progress/qty) 1-2</p> <p>(XPath: KnitClothOrder/KCCObody/KCCOitem/apparelComponent/yarnComponent/qty) 1-2</p> <p>- note: <i>quantity to be consumed in the manufacturing operation</i></p> <p>(XPath: KnitClothOrder/KCCObody/KCCOitem/apparelProd/qty) 1-2</p> <p>(XPath: KnitClothOrder/KCCObody/KCCOitem/apparelComponent/acsComponent/qty) 1-2</p>
qtyVariance	<p>difference between two quantities qualified by the context (e.g.: delivered vs. ordered; received vs. despatched etc..)</p> <p>- base type: decimal, fraction digits: 2,</p> <p>(XPath: KnitClothOrder/KCCObody/KCCOitem/garTecSheet/garConsumptionSet/garConsumption/qtyVariance) 0-1</p> <p>- note: <i>here is the difference between provisional and effective consumption</i></p>
@role	<p>Third Party role qualifier</p> <p>- base type: string, cod. table: NT2</p> <p>http://www.moda-ml.net/moda-ml/repository/codelist/v2013-1/gc_NT2.xml</p> <p>(XPath: KnitClothOrder/KCCObody/KCCOitem/thirdParty/@role) [Required]</p>

	(XPath: KnitClothOrder/KCCOheader/thirdParty/@role) [Required]
season	<p>sale season; defined as: season (1 crt) + year (4 crt) - season: S/S=1 A/W=2 Spring=3 Summer=4 Autumn=5 Winter=6: for more than four seasons use alphabetic sequence: 1st season=A 2nd season=B etc.etc.</p> <p>- base type: string, max length: 15,</p> <p>(XPath: KnitClothOrder/KCCObody/KCCOitem/apparelComponent/garmentPartComponent/refDoc/season) 0-1</p> <p>- note: <i>here indicates the season to which the referenced document belongs</i></p> <p>(XPath: KnitClothOrder/KCCObody/KCCOitem/apparelComponent/acsComponent/refDoc/season) 0-1</p> <p>- note: <i>here indicates the season to which the referenced document belongs</i></p> <p>(XPath: KnitClothOrder/KCCObody/KCCOitem/garTecSheet/refDoc/season) 0-1</p> <p>- note: <i>here indicates the season to which the referenced document belongs</i></p> <p>(XPath: KnitClothOrder/KCCObody/KCCOitem/appMnfrOperation/refDoc/season) 0-1</p> <p>- note: <i>here indicates the season to which the referenced document belongs</i></p> <p>(XPath: KnitClothOrder/KCCObody/KCCOitem/apparelComponent/fabricComponent/refDoc/season) 0-1</p> <p>- note: <i>here indicates the season to which the referenced document belongs</i></p> <p>(XPath: KnitClothOrder/KCCObody/KCCOitem/apparelComponent/yarnComponent/refDoc/season) 0-1</p> <p>- note: <i>here indicates the season to which the referenced document belongs</i></p> <p>(XPath: KnitClothOrder/KCCOheader/refDoc/season) 0-1</p> <p>- note: <i>here indicates the season to which the referenced document belongs</i></p> <p>(XPath: KnitClothOrder/KCCOheader/season) 0-1</p>
@sender	<p>qualifier that specifies the Party issuing of the document</p> <p>- base type: boolean,</p> <p>(XPath: KnitClothOrder/KCCObody/KCCOitem/thirdParty/@sender) [Optional]</p> <p>- nota: <i>This attribute is mandatory when the STYLESHEET must be produced</i></p> <p>(XPath: KnitClothOrder/KCCOheader/subContractor/@sender) [Optional]</p> <p>- nota: <i>This attribute is mandatory when the STYLESHEET must be produced</i></p> <p>(XPath: KnitClothOrder/KCCOheader/thirdParty/@sender) [Optional]</p> <p>- nota: <i>This attribute is mandatory when the STYLESHEET must be produced</i></p> <p>(XPath: KnitClothOrder/KCCOheader/buyer/@sender) [Optional]</p> <p>- nota: <i>This attribute is mandatory when the STYLESHEET must be produced</i></p>
serialN	<p>serial number used for the identification of a physical unit</p> <p>- base type: string, max length: 15,</p> <p>(XPath: KnitClothOrder/KCCObody/KCCOitem/apparelComponent/fabricComponent/serialN) 0-99</p> <p>- note: <i>it may be used to identify the pieces/chains that the Subcontractor must use for the commissioned work</i></p>
size	<p>size number of a garment product (kintwear/clothing)</p> <p>- base type: string, max length: 15,</p> <p>(XPath: KnitClothOrder/KCCObody/KCCOitem/garTecSheet/garMeaSet/garMea/size) 0-1</p> <p>(XPath: KnitClothOrder/KCCObody/KCCOitem/apparelProd/</p>

	<p>csRange/sizeMatrix/sizeRow/size) 1-1 (XPath: KnitClothOrder/KCCObody/KCCOitem/apparelProd/garmentPartCode/size) 0-1 (XPath: KnitClothOrder/KCCObody/KCCOitem/apparelComponent/garmentPartComponent/garmentPartCode/size) 0-1 (XPath: KnitClothOrder/KCCObody/KCCOitem/apparelProd/garmentCode/garmentCodeB/size) 0-1 (XPath: KnitClothOrder/KCCObody/KCCOitem/garTecSheet/garmentCode/garmentCodeB/size) 0-1</p>
sizeEnd	<p>first size of a range of sizes - base type: string, max length: 15, (XPath: KnitClothOrder/KCCObody/KCCOitem/garTecSheet/garSizeSet/garSizeTier/sizeEnd) 0-1</p>
sizeStart	<p>first size of a range of sizes - base type: string, max length: 15, (XPath: KnitClothOrder/KCCObody/KCCOitem/garTecSheet/garSizeSet/garSizeTier/sizeStart) 1-1</p>
@sizeSystemBase	<p>base of the size system - base type: string, cod. table: T423 http://www.moda-ml.net/moda-ml/repository/codelist/v2013-1/gc_T423.xml (XPath: KnitClothOrder/KCCObody/KCCOitem/apparelProd/csRange/@sizeSystemBase) [Optional]</p>
@sizeSystemNat	<p>nation or agency identifying the size system - base type: string, cod. table: T421 http://www.moda-ml.net/moda-ml/repository/codelist/v2013-1/gc_T421.xml (XPath: KnitClothOrder/KCCObody/KCCOitem/apparelProd/csRange/@sizeSystemNat) [Optional]</p>
@sizeSystemSeg	<p>market segment identifying the size system - base type: string, cod. table: T422 http://www.moda-ml.net/moda-ml/repository/codelist/v2013-1/gc_T422.xml (XPath: KnitClothOrder/KCCObody/KCCOitem/apparelProd/csRange/@sizeSystemSeg) [Optional]</p>
@source	<p>party who has provided the data - base type: string, cod. table: NT12 http://www.moda-ml.net/moda-ml/repository/codelist/v2013-1/gc_NT12.xml (XPath: KnitClothOrder/KCCObody/KCCOitem/garTecSheet/garMeaSet/garMea/specValue/@source) [Optional]</p>
specValue	<p>value requested for a property or a parameter that is measured - base type: decimal, (XPath: KnitClothOrder/KCCObody/KCCOitem/garTecSheet/garMeaSet/garMea/specValue) 1-1</p>
street	<p>street and building number identifying a location - base type: string, max length: 80, (XPath: KnitClothOrder/KCCOheader/buyer/street) 0-1 (XPath: KnitClothOrder/KCCOheader/subContractor/street) 0-1 (XPath: KnitClothOrder/KCCOheader/thirdParty/street) 0-1 (XPath: KnitClothOrder/KCCObody/KCCOitem/thirdParty/street) 0-1</p>
subCountry	<p>short name or code of the sub-country entity - base type: string, max length: 9, (XPath: KnitClothOrder/KCCOheader/subContractor/subCountry) 0-1 (XPath: KnitClothOrder/KCCOheader/buyer/subCountry) 0-1 (XPath: KnitClothOrder/KCCObody/KCCOitem/thirdParty/subCountry) 0-1 (XPath: KnitClothOrder/KCCOheader/thirdParty/subCountry) 0-1</p>
@subject	<p>qualifier of the product treated in the note - base type: string, cod. table: NT40 http://www.moda-ml.net/moda-ml/repository/codelist/v2013-1/gc_NT40.xml (XPath: KnitClothOrder/KCCObody/KCCOitem/garTecSheet/</p>

	<p>mnfrNote/@subject) [Optional] (XPath: KnitClothOrder/KCCObody/KCCOitem/garTecSheet/image/@subject) [Optional]</p>
taxCategory	<p>duty or tax or fee category - base type: string, cod. table: T62 http://www.moda-ml.net/moda-ml/repository/codelist/v2013-1/gc_T62.xml (XPath: KnitClothOrder/KCCObody/KCCOitem/dtScheme/taxCategory) 0-1 (XPath: KnitClothOrder/terms/allowanceCharge/dtScheme/taxCategory) 0-1</p>
taxRate	<p>duty or tax or fee percent rate - base type: string, (XPath: KnitClothOrder/terms/allowanceCharge/dtScheme/taxRate) 0-1 (XPath: KnitClothOrder/KCCObody/KCCOitem/dtScheme/taxRate) 0-1</p>
@taxType	<p>duty or tax or fee type - base type: string, cod. table: T61 http://www.moda-ml.net/moda-ml/repository/codelist/v2013-1/gc_T61.xml (XPath: KnitClothOrder/terms/allowanceCharge/dtScheme/@taxType) [Required] (XPath: KnitClothOrder/KCCObody/KCCOitem/dtScheme/@taxType) [Required]</p>
transCondition	<p>special condition of transport or special service requested to the Forwarder - base type: string, cod. table: T38 http://www.moda-ml.net/moda-ml/repository/codelist/v2013-1/gc_T38.xml (XPath: KnitClothOrder/terms/transInfo/transCondition) 0-3</p>
transConditionText	<p>free text description of the special condition of transport or special service requested to the Forwarder - base type: string, max length: 100, (XPath: KnitClothOrder/terms/transInfo/transConditionText) 0-1</p>
transMeans	<p>means of transport, in general or referred to a specific leg - base type: string, cod. table: T40 http://www.moda-ml.net/moda-ml/repository/codelist/v2013-1/gc_T40.xml (XPath: KnitClothOrder/terms/transInfo/transMeans) 0-1</p>
transMode	<p>way of transport, in general or referred to the specified leg - base type: string, cod. table: T8 http://www.moda-ml.net/moda-ml/repository/codelist/v2013-1/gc_T8.xml (XPath: KnitClothOrder/terms/transInfo/transMode) 1-1</p>
@transReason	<p>reason for the transport - base type: string, cod. table: NT11 http://www.moda-ml.net/moda-ml/repository/codelist/v2013-1/gc_NT11.xml (XPath: KnitClothOrder/terms/transInfo/@transReason) [Optional]</p>
@um	<p>specification of the unit of measure - base type: string, cod. table: NT7 http://www.moda-ml.net/moda-ml/repository/codelist/v2013-1/gc_NT7.xml (XPath: KnitClothOrder/terms/transInfo/grossWeight/@um) [Required] (XPath: KnitClothOrder/KCCObody/KCCOitem/apparelComponent/garmentPartComponent/qty/@um) [Required] (XPath: KnitClothOrder/KCCObody/KCCOitem/garTecSheet/garMeaSet/garMea/specValue/@um) [Optional] (XPath: KnitClothOrder/KCCObody/KCCOitem/apparelProd/qty/@um) [Required] (XPath: KnitClothOrder/KCCObody/KCCOitem/apparelComponent/yarnComponent/pcQty/@um) [Optional] - nota: <i>to be used when it has to be soecified if the declared percentage is by weight, volume, etc...</i> (XPath: KnitClothOrder/KCCObody/KCCOitem/garTecSheet/garConsumptionSet/garConsumption/qty/@um) [Required] (XPath: KnitClothOrder/KCCObody/KCCOitem/garTecSheet/</p>

	<p>garConsumptionSet/garConsumption/qtyVariance/@um) [Optional] (XPath: KnitClothOrder/KCCObody/KCCOitem/progress/qty/@um) [Required] (XPath: KnitClothOrder/KCCObody/KCCOitem/apparelComponent/fabricComponent/qty/@um) [Required] (XPath: KnitClothOrder/KCCObody/KCCOitem/garTecSheet/grossWeight/@um) [Required] (XPath: KnitClothOrder/KCCObody/KCCOitem/garTecSheet/netWeight/@um) [Required] (XPath: KnitClothOrder/KCCObody/KCCOitem/apparelProd/csRange/sizeMatrix/sizeRow/qty/@um) [Required] (XPath: KnitClothOrder/KCCObody/KCCOitem/price/@um) [Optional] - nota: <i>Unit of measure of the product to which the price is referred (price per meter)</i> (XPath: KnitClothOrder/KCCObody/KCCOitem/apparelComponent/yarnComponent/qty/@um) [Required] (XPath: KnitClothOrder/terms/transInfo/netWeight/@um) [Required] (XPath: KnitClothOrder/KCCObody/KCCOitem/apparelComponent/acsComponent/qty/@um) [Required]</p>
@useProfile	<p>use profile to which the present document is compliant if it was agreed by the parties. It is suggested a URI with reference to the firms or the URL of the profile. - base type: string, (XPath: KnitClothOrder/@useProfile) [Optional]</p>
@varReason	<p>reason for the difference between the two quantities specified by the context - base type: string, cod. table: T46 http://www.moda-ml.net/moda-ml/repository/codelist/v2013-1/gc_T46.xml (XPath: KnitClothOrder/KCCObody/KCCOitem/garTecSheet/garConsumptionSet/garConsumption/qtyVariance/@varReason) [Optional]</p>
@VAT	<p>VAT rate or code (deprecated, use dtScheme element) - base type: string, cod. table: NT16 http://www.moda-ml.net/moda-ml/repository/codelist/v2013-1/gc_NT16.xml (XPath: KnitClothOrder/KCCObody/KCCOitem/thirdParty/@VAT) [Optional] (XPath: KnitClothOrder/terms/allowanceCharge/@VAT) [Optional] (XPath: KnitClothOrder/KCCObody/KCCOitem/lineN/@VAT) [Optional] (XPath: KnitClothOrder/KCCOheader/thirdParty/@VAT) [Optional]</p>
@version	<p>Dictionary version from which the instance has been created - base type: string, cod. table: NT100 http://www.moda-ml.net/moda-ml/repository/codelist/v2013-1/gc_NT100.xml (XPath: KnitClothOrder/@version) [Optional] [Default= 2013-1]</p>
warpLetter	<p>letter that indicates a specific yarn in the warping formula (diagram) - base type: string, length: 1, (XPath: KnitClothOrder/KCCObody/KCCOitem/apparelComponent/yarnComponent/warpLetter) 0-1 - note: <i>to be used only in the Warping order</i></p>
weftLetter	<p>letter that indicates a specific yarn in the wefting formula (diagram) - base type: string, length: 1, (XPath: KnitClothOrder/KCCObody/KCCOitem/apparelComponent/yarnComponent/weftLetter) 0-1 - note: <i>to be used only in the Weaving order</i></p>

2.3 Enumeration tables

List of enumeration tables used in the XML document. You can find the corresponding codes at: <http://www.moda-ml.org/moda-ml/imple/moda-ml-2013-1.asp?lingua=en&pag=6>

NT100 - eBIZ Moda-ML version
NT11 - transport causal
NT12 - data source
NT16 - VAT rate or code
NT18 - message function
NT2 - third party qualifier
NT20 - price qualifier
NT22 - product type of an operation
NT29 - format of a date
NT3 - data format
NT37 - committed quantity qualifier
NT40 - manufacturing note qualifiers
NT41 - garment attributes
NT6 - coding system owner/issuer
NT7 - unity of measure
T1 - terms of payment
T10 - ISO3166 - Country
T19 - fibre type
T2 - Modes of payment
T205 - type of job in knitting/clothing
T21 - type of document
T265 - type of job technology in knitting/clothing
T275 - type of machine for knitting/clothing
T3 - terms of delivery
T38 - transport conditions
T40 - type of transport means
T41 - type of Allowance or Charge
T421 - size system: nationality
T422 - size system: market segment
T423 - size system: base
T44 - additional code type
T46 - quantity variance reason
T48 - garment part type
T61 - duty or tax or fee type
T62 - duty or tax or fee category
T7 - manufacturing status
T8 - Modes of Transport
T9 - ISO4217 - Currency

Annex A

Representative images of the principal complex elements' structure.

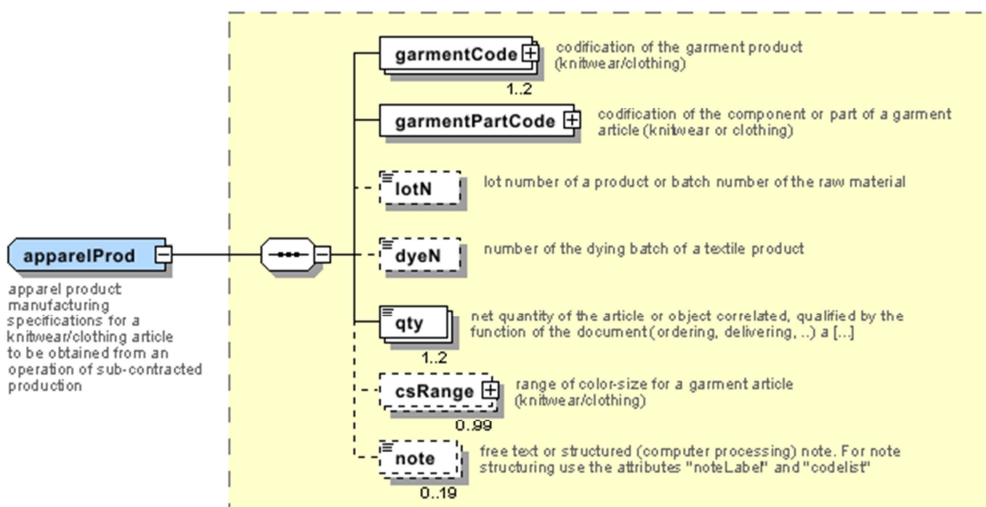
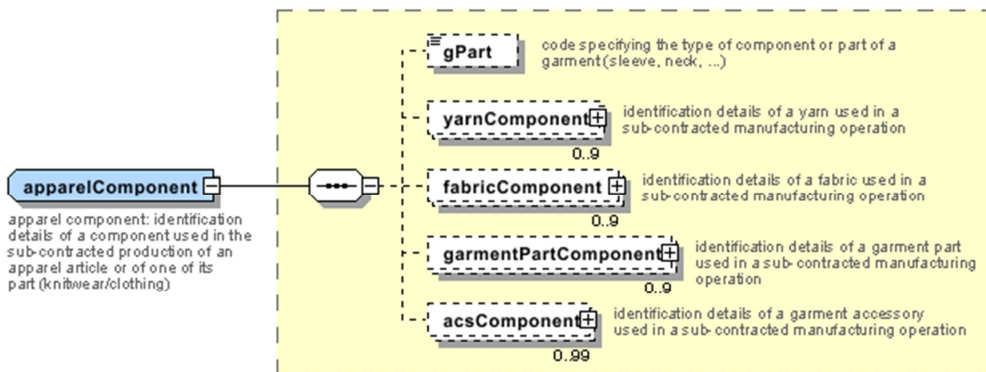
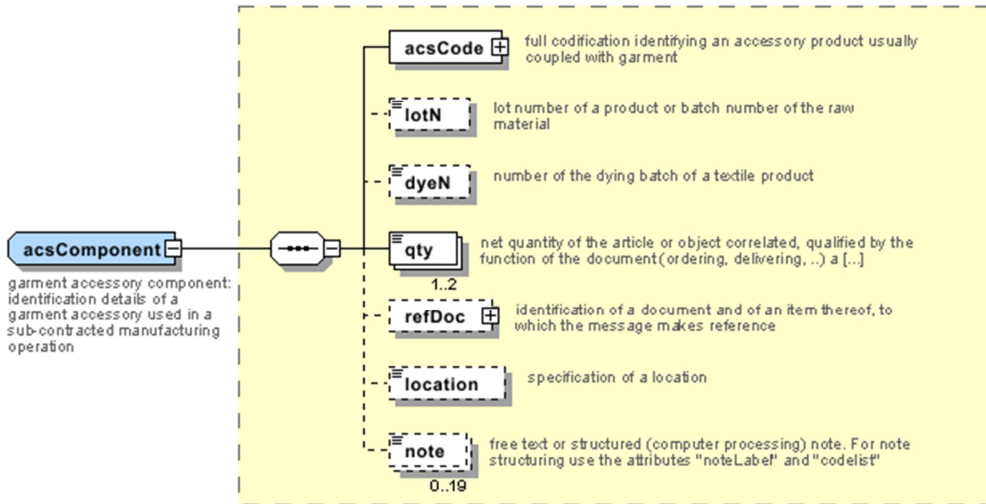

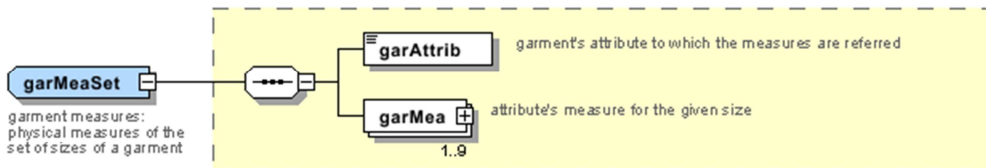
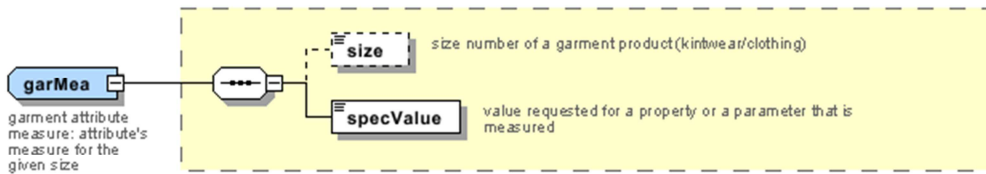
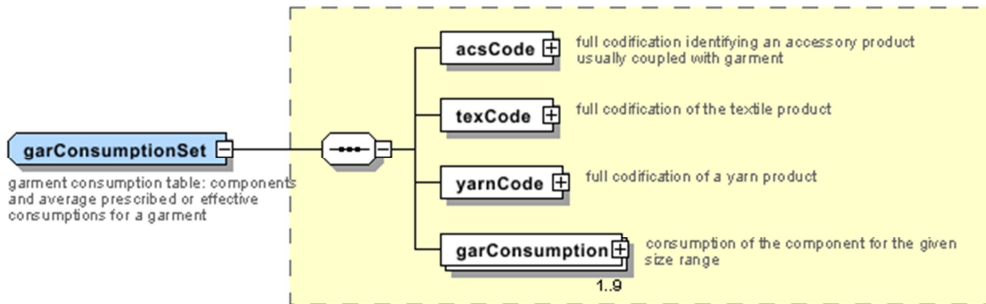
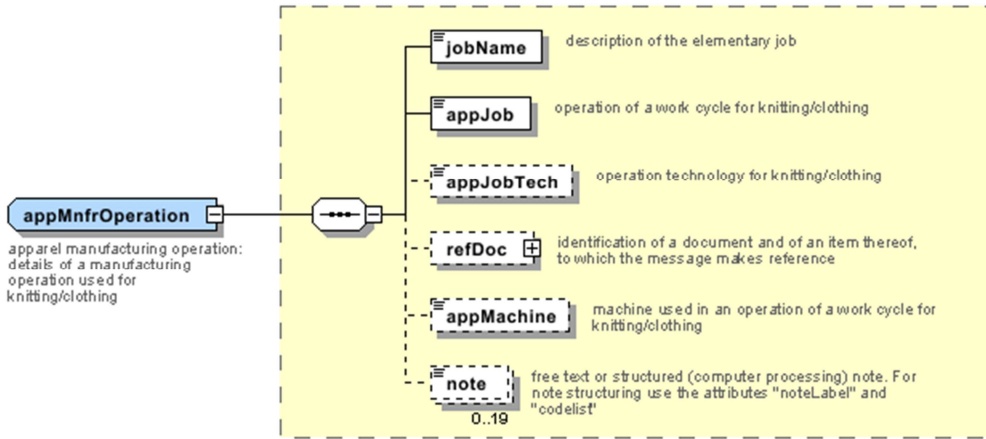

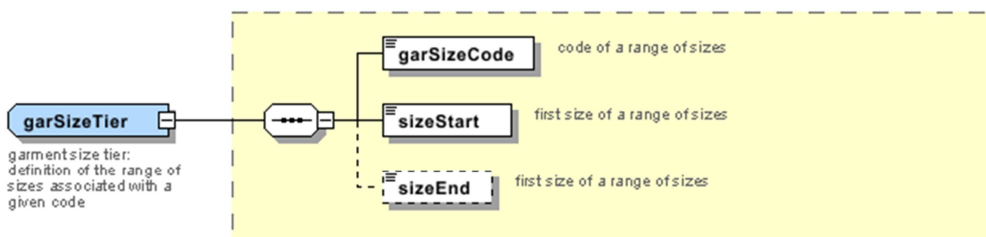
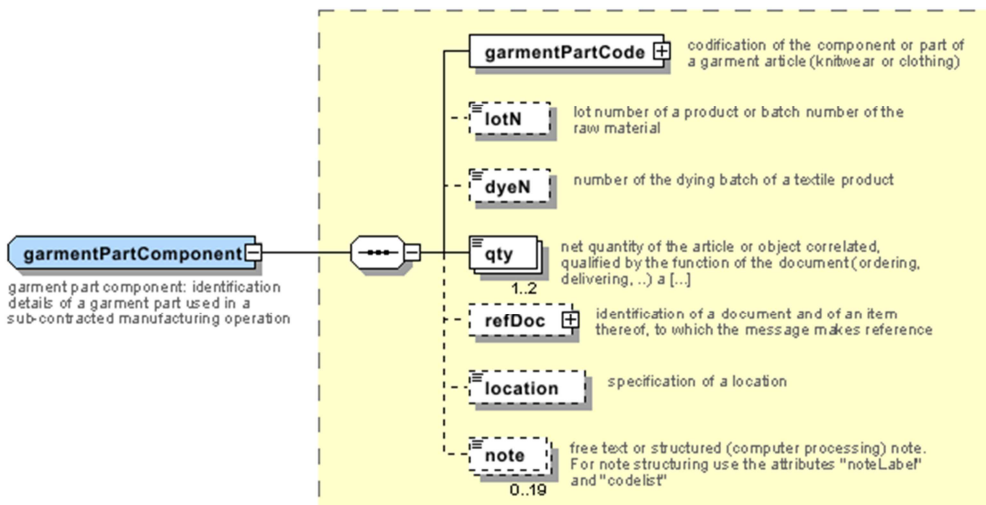
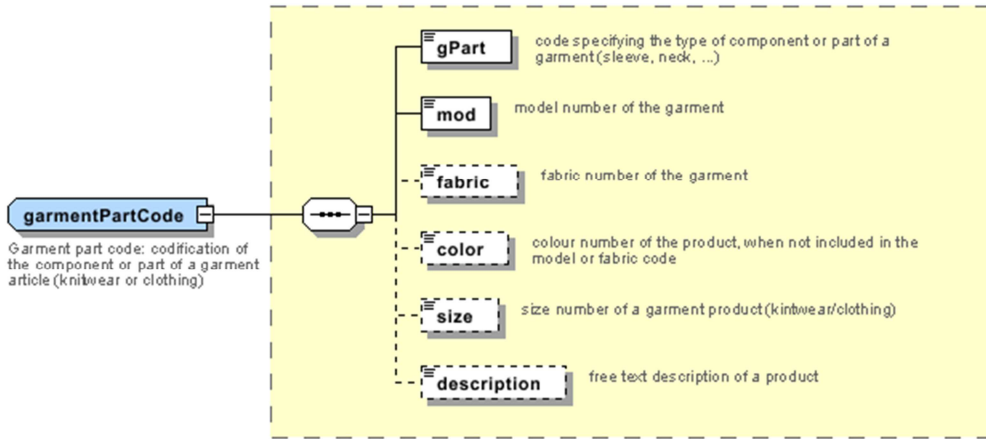

garTecSheet
 garment technical sheet:
 garment technical sheet

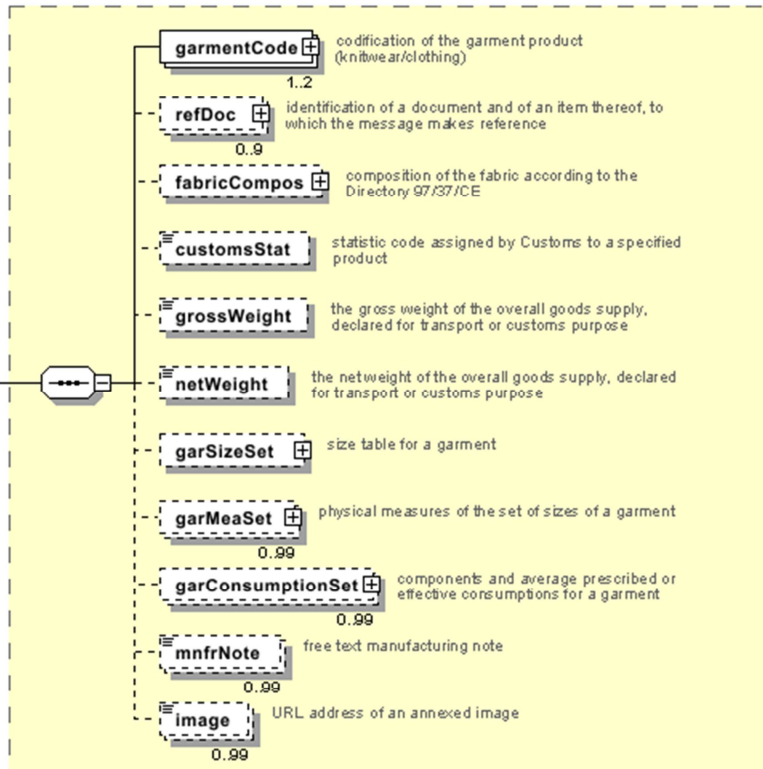

KCCOheader
 KCCO header:
 header of the document
 KNITTING/CLOTHING
 COMMISSION
 ORDER

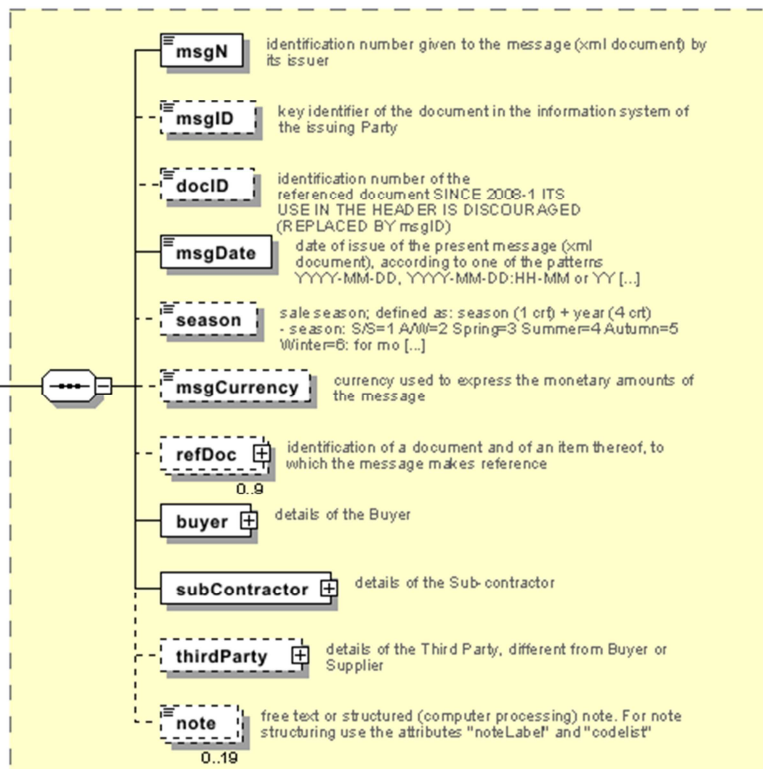

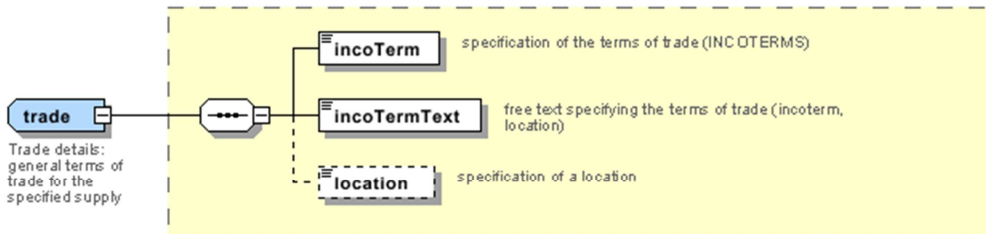
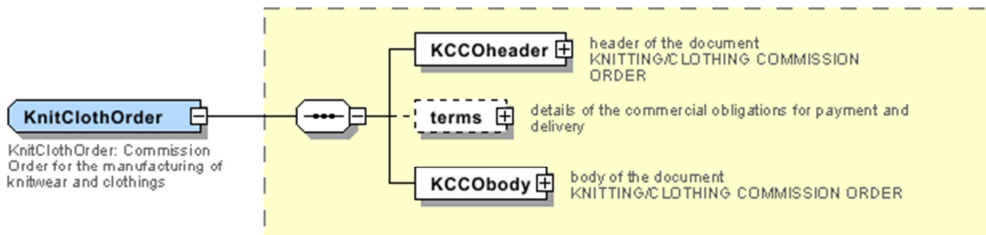
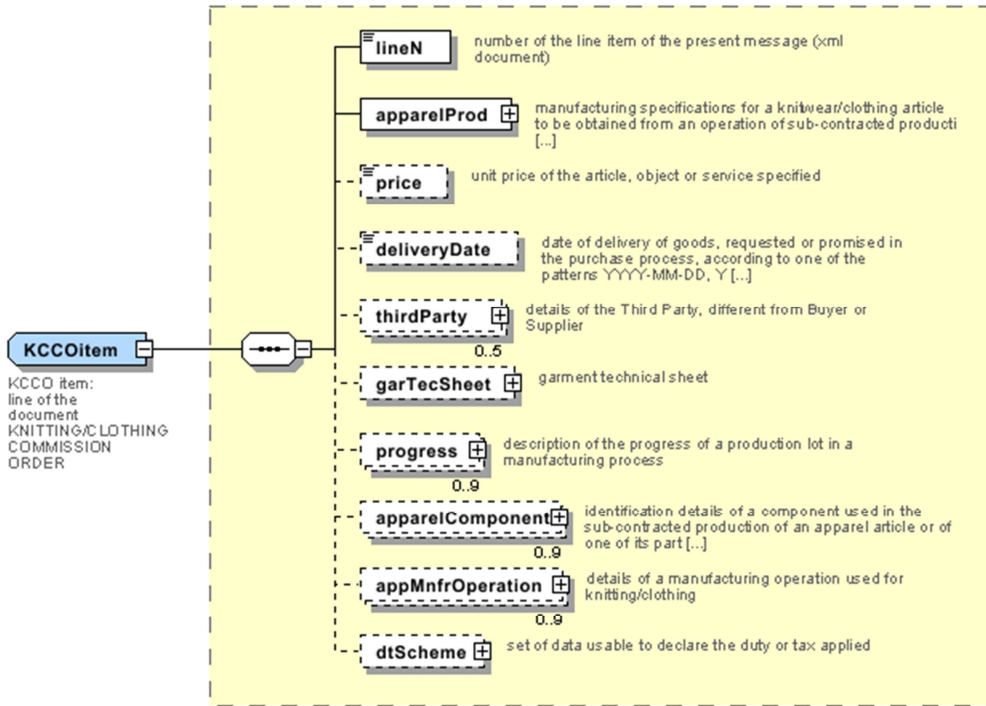

yarnComponent
 yarn component: identification details of a yarn used in a sub-contracted manufacturing operation

