



<http://www.ebiz-tcf.eu>

**DRAFT**

**IMPLEMENTATION GUIDE**

**TRANSACTION "FASHION CATALOGUE"**

Version: draft

Date of release: 17/5/2019

Document code: G080

technical Documentation: <http://www.ebiz.enea.it>

XML Schemas repository: <http://www.ebiz.enea.it/moda-ml/repository/schema/draft/default.asp>

Guides repository: <http://www.ebiz.enea.it/moda-ml/repository/guide/draft/default.asp>

Guide filename: G080-eBIZ-FashionCatalogue.pdf

## 0. PREMISE

This document contains a proposal for the updating and extension of eBIZ specifications starting from the eBIZ version released as CEN CWA 16667 in 2013. Under the name of 'Draft version' it is reported the result of an extensive work of analysis and consultation aimed at developing and maintaining eBIZ specifications.

In particular, the content of this proposal is the result of various activities, mainly those carried out within the framework of the **eBIZ 4.0 project** funded by the European Commission, call COS-DESIGN-2015-3-06, topic COS-2015-DESIGN-2.

The technical contents are backwards compatible with the latest official published version.

## 1. BUSINESS DESCRIPTION

### 1.1 Scope

The present guide has been issued to assist the companies of the Fashion sector in the implementation of the standard XML document type "FASHION CATALOGUE", providing all the instruction required for its use in any context of e-commerce between Fashion Producers and their customers and eBusiness and eCommerce platforms.

All the rules required for the construction and validation of the document are embedded into the specific XML-Schema, which is detailed in section "Implementation guide".

### 1.2 Generalities

This document is usable as a catalog (showcase / offer) as well as to exchange in advance the product data between Suppliers and Customers, in order to allow the synchronization of the corresponding data-base. . Furthermore, a Producer can use it to publish its offer on ePlatforms.

It contains the items that compose the Fashion Manufacturer's offer (codes, descriptions, prices and terms of sale) and may include some technical-descriptive data of the product (trade name, composition, weight and height, . . .) as well as marketing information (images, verbose descriptions, . . .)

### 1.3. Possible scenario

Initial transmission of information to eService

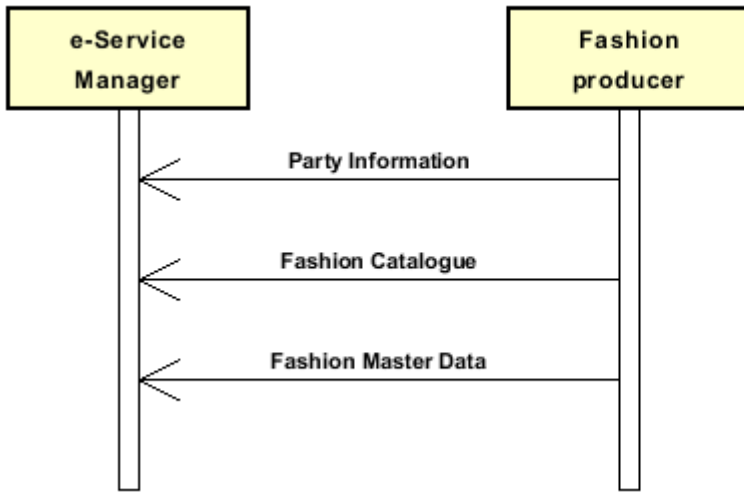

## 2. IMPLEMENTATION GUIDE

### 2.1 General structure of XML document

All the business data that can be exchanged through this class of documents are shown in the following "document structure", that provides a simplified vision of the Schema.

In particular:

- the two numbers following each element define its "cardinality" (minimum and maximum number of occurrences); the minimum equal zero indicates that the element is optional, the minimum greater than zero indicates that is mandatory;
- the bold character denotes the complex elements (aggregates of simple elements) that were built for the sake of functionality and re-usability of some complex informations sets. The child elements in each parent element are easily spotted as "indented";
- the symbol "@" denotes an attribute of the preceding element; here "the usage indicator (optional, required, ...)" is shown in square brackets.

### Structure

#### FASCatalog

*@version [Optional] [Default= draft]*

*@useProfile [Optional]*

```
| FCHheader 1-1
| | msgN 1-1
| | msgID 0-1
| | msgDate 1-1
| | @dateForm [Optional]
| | msgCurrency 0-1
| | refDoc 0-9
| | @docType [Required]
| | | docID 1-2
| | | @numberingOrg [Optional]
| | | docDate 0-1
| | | @dateForm [Optional]
| | | season 0-1
| | | @numberingOrg [Optional]
| | | @codeList [Optional]
| | | @listName [Optional]
| | | @listVersion [Optional]
| | | itemID 0-1
| | | attachment 0-1
| | | @uid [Optional]
| | | | fileName 0-1
| | | | @numberingOrg [Optional]
| | | | binaryObject 0-1
| | | | @format [Optional]
| | | | @mime [Optional]
| | | | @encoding [Optional]
| | | | @characterSet [Optional]
| | | | externalReference 0-99
| | | | | uri 1-1
| | | | | @isURL [Optional] [Default= true]
| | | | | mimeTypeCode 0-1
| | | | | formatCode 0-1
| | | | | encodingCode 0-1
| | | | | characterSetCode 0-1
| | picture 0-9
| | | pictureCode 0-1
| | | title 0-unbounded
| | | @ln [Optional]
```

- | description 0-unbounded
- | *@In [Optional]*
- | validityStart 0-1
- | *@dateForm [Optional]*
- | validityEnd 0-1
- | *@dateForm [Optional]*
- | alternativeText 0-unbounded
- | *@In [Optional]*
- | rendering 0-1
- | resolution 0-1
- | *@resolutionType [Optional] [Default= dpi]*
- | width 0-1
- | *@um [Required]*
- | height 0-1
- | *@um [Required]*
- | nominalWidth 0-2
- | *@um [Optional]*
- | nominalHeight 0-2
- | *@um [Optional]*
- | pictureUse 0-1
- | pictureQualifier 0-1
- | **attachment 1-1**
- | *@uid [Optional]*
  - | fileName 0-1
  - | *@numberingOrg [Optional]*
  - | binaryObject 0-1
  - | *@format [Optional]*
  - | *@mime [Optional]*
  - | *@encoding [Optional]*
  - | *@characterSet [Optional]*
  - | **externalReference 0-99**
    - | uri 1-1
    - | *@isURL [Optional] [Default= true]*
    - | mimeTypeCode 0-1
    - | formatCode 0-1
    - | encodingCode 0-1
    - | characterSetCode 0-1
- | note 0-99
- | *@numberingOrg [Optional]*
- | *@codeList [Optional]*
- | *@noteLabel [Optional]*
- | season 0-1
- | *@numberingOrg [Optional]*
- | *@codeList [Optional]*
- | *@listName [Optional]*
- | *@listVersion [Optional]*
- | validityStart 0-1
- | *@dateForm [Optional]*
- | validityEnd 0-1
- | *@dateForm [Optional]*
- | **buyer 0-1**
- | *@logo [Optional]*
- | *@sender [Optional]*
  - | id 1-1
  - | *@numberingOrg [Optional]*
  - | additionalIdentifier 0-9
  - | *@numberingOrg [Optional]*
  - | *@idQualifier [Optional]*
  - | legalName 0-1
  - | dept 0-1
  - | subDept 0-1

```

| | | person 0-1
| | |   @email [Optional]
| | |   @phone [Optional]
| | |   @fax [Optional]
| | | street 0-1
| | | city 0-1
| | | subCountry 0-1
| | | country 0-1
| | | postCode 0-1
| | supplier 1-1
| | | @logo [Optional]
| | | @sender [Optional]
| | |   id 1-1
| | |   @numberingOrg [Optional]
| | | additionalIdentifier 0-9
| | |   @numberingOrg [Optional]
| | |   @idQualifier [Optional]
| | | legalName 0-1
| | | dept 0-1
| | | subDept 0-1
| | | person 0-1
| | |   @email [Optional]
| | |   @phone [Optional]
| | |   @fax [Optional]
| | | street 0-1
| | | city 0-1
| | | subCountry 0-1
| | | country 0-1
| | | postCode 0-1
| | thirdParty 0-5
| | | @VAT [Optional]
| | | @role [Required]
| | | @sender [Optional]
| | |   id 1-1
| | |   @numberingOrg [Optional]
| | | legalName 0-1
| | | dept 0-1
| | | subDept 0-1
| | | person 0-1
| | |   @email [Optional]
| | |   @phone [Optional]
| | |   @fax [Optional]
| | | street 0-1
| | | city 0-1
| | | subCountry 0-1
| | | country 0-1
| | | postCode 0-1
| | note 0-99
| | | @numberingOrg [Optional]
| | | @codeList [Optional]
| | | @noteLabel [Optional]
| terms 0-1
| | payment 0-5
| | | @finDiscount [Optional]
| | | @finSurcharge [Optional]
| | | - choose -
| | | | payTerm 1-1
| | | | - or -
| | | | payTermText 1-1
| | | | - end choose -

```

```

| | | payMode 0-1
| | insPayment 0-5
| | @part [Required]
| | - choose -
| | | payTerm 1-1
| | - or -
| | | payTermText 1-1
| | - end choose -
| | | payMode 0-1
| | trade 0-1
| | - choose -
| | | incoTermText 1-1
| | - or -
| | | incoTerm 1-1
| | - end choose -
| | | location 0-1
| | | @LRI [Optional]
| | transInfo 0-5
| | @transReason [Optional]
| | @progr [Optional]
| | | transMode 1-1
| | | carrier 0-1
| | | deliveryPlace 0-1
| | | grossWeight 0-1
| | | @um [Required]
| | | netWeight 0-1
| | | @um [Required]
| | | transMeans 0-1
| | | transCondition 0-3
| | | transConditionText 0-1
| | | despatchPlace 0-1
| | | despatchDate 0-1
| | | @dateForm [Optional]
| | | delEffectiveDate 0-1
| | | @dateForm [Optional]
| | allowanceCharge 0-9
| | @um [Optional]
| | @VAT [Optional]
| | @minQty [Optional]
| | @currency [Optional]
| | @maxQty [Optional]
| | - choose -
| | | AC_category 1-1
| | - or -
| | | AC_categoryText 1-1
| | - end choose -
| | - choose -
| | | AC_percent 1-1
| | - or -
| | | AC_amount 1-1
| | - end choose -
| | | dtScheme 0-1
| | | @taxType [Required]
| | | | taxCategory 0-1
| | | | taxRate 0-1
| | | | legalRef 0-1
| | | | @codeList [Required]
| | | | note 0-99
| | | | @numberingOrg [Optional]
| | | | @codeList [Optional]
| | | | @noteLabel [Optional]

```

**garComInfo 0-1**

- @endUse [Optional]*
- season 0-1
  - @numberingOrg [Optional]*
  - @codeList [Optional]*
  - @listName [Optional]*
  - @listVersion [Optional]*
- brand 0-1
  - @numberingOrg [Optional]*
  - @codeList [Optional]*
  - @listName [Optional]*
  - @listVersion [Optional]*
- productLine 0-1
  - @numberingOrg [Optional]*
  - @codeList [Optional]*
  - @listName [Optional]*
  - @listVersion [Optional]*
- project 0-1
- operationalCode 0-19
  - @numberingOrg [Optional]*
  - @codeList [Optional]*
  - @listName [Optional]*
  - @listVersion [Optional]*
  - @codeQualifier [Optional]*
- deliveryDate 0-1
  - @dateForm [Optional]*
- specDate 0-1
  - @dateForm [Optional]*
- note 0-99
  - @numberingOrg [Optional]*
  - @codeList [Optional]*
  - @noteLabel [Optional]*

**FCbody 1-1****FCgroup 1-unbounded**

- artGroup 0-1
  - @numberingOrg [Optional]*
  - @codeList [Optional]*
  - @listName [Optional]*
  - @listVersion [Optional]*
- artGroupName 0-1
- description 0-unbounded
  - @ln [Optional]*
- extendedDescription 0-unbounded
  - @ln [Optional]*
- refDoc 0-9**
  - @docType [Required]*
  - docID 1-2
    - @numberingOrg [Optional]*
  - docDate 0-1
    - @dateForm [Optional]*
  - season 0-1
    - @numberingOrg [Optional]*
    - @codeList [Optional]*
    - @listName [Optional]*
    - @listVersion [Optional]*
  - itemID 0-1
- attachment 0-1**
  - @uid [Optional]*
  - fileName 0-1



| @numberingOrg [Optional]  
 | binaryObject 0-1  
 | @format [Optional]  
 | @mime [Optional]  
 | @encoding [Optional]  
 | @characterSet [Optional]  
 | **externalReference 0-99**  
 | | uri 1-1  
 | | @isURL [Optional] [Default= true]  
 | | mimeTypeCode 0-1  
 | | formatCode 0-1  
 | | encodingCode 0-1  
 | | characterSetCode 0-1  
**picture 0-99**  
 | pictureCode 0-1  
 | title 0-unbounded  
 | @In [Optional]  
 | description 0-unbounded  
 | @In [Optional]  
 | validityStart 0-1  
 | @dateForm [Optional]  
 | validityEnd 0-1  
 | @dateForm [Optional]  
 | alternativeText 0-unbounded  
 | @In [Optional]  
 | rendering 0-1  
 | resolution 0-1  
 | @resolutionType [Optional] [Default= dpi]  
 | width 0-1  
 | @um [Required]  
 | height 0-1  
 | @um [Required]  
 | nominalWidth 0-2  
 | @um [Optional]  
 | nominalHeight 0-2  
 | @um [Optional]  
 | pictureUse 0-1  
 | pictureQualifier 0-1  
**attachment 1-1**  
 | @uid [Optional]  
 | | fileName 0-1  
 | | @numberingOrg [Optional]  
 | | binaryObject 0-1  
 | | @format [Optional]  
 | | @mime [Optional]  
 | | @encoding [Optional]  
 | | @characterSet [Optional]  
 | | **externalReference 0-99**  
 | | | uri 1-1  
 | | | @isURL [Optional] [Default= true]  
 | | | mimeTypeCode 0-1  
 | | | formatCode 0-1  
 | | | encodingCode 0-1  
 | | | characterSetCode 0-1  
 | note 0-99  
 | @numberingOrg [Optional]  
 | @codeList [Optional]  
 | @noteLabel [Optional]  
**allowanceCharge 0-9**  
 | @um [Optional]  
 | @VAT [Optional]

```

| | | @minQty [Optional]
| | | @currency [Optional]
| | | @maxQty [Optional]
| | | - choose -
| | | | AC_category 1-1
| | | - or -
| | | | AC_categoryText 1-1
| | | - end choose -
| | | - choose -
| | | | AC_percent 1-1
| | | - or -
| | | | AC_amount 1-1
| | | - end choose -
| | | dtScheme 0-1
| | | | @taxType [Required]
| | | | | taxCategory 0-1
| | | | | taxRate 0-1
| | | | | legalRef 0-1
| | | | | @codeList [Required]
| | | | | note 0-99
| | | | | @numberingOrg [Optional]
| | | | | @codeList [Optional]
| | | | | @noteLabel [Optional]
| | | garComInfo 0-1
| | | | @endUse [Optional]
| | | | | season 0-1
| | | | | @numberingOrg [Optional]
| | | | | @codeList [Optional]
| | | | | @listName [Optional]
| | | | | @listVersion [Optional]
| | | | | brand 0-1
| | | | | @numberingOrg [Optional]
| | | | | @codeList [Optional]
| | | | | @listName [Optional]
| | | | | @listVersion [Optional]
| | | | | productLine 0-1
| | | | | @numberingOrg [Optional]
| | | | | @codeList [Optional]
| | | | | @listName [Optional]
| | | | | @listVersion [Optional]
| | | | | project 0-1
| | | | | operationalCode 0-19
| | | | | @numberingOrg [Optional]
| | | | | @codeList [Optional]
| | | | | @listName [Optional]
| | | | | @listVersion [Optional]
| | | | | @codeQualifier [Optional]
| | | | | deliveryDate 0-1
| | | | | @dateForm [Optional]
| | | | | specDate 0-1
| | | | | @dateForm [Optional]
| | | | | note 0-99
| | | | | @numberingOrg [Optional]
| | | | | @codeList [Optional]
| | | | | @noteLabel [Optional]
| | | FCitem 0-unbounded
| | | | lineN 0-1
| | | | | @VAT [Optional]
| | | | | lineID 0-1
| | | | refDoc 0-9
| | | | | @docType [Required]

```

| docID 1-2  
 | @numberingOrg [Optional]  
 | docDate 0-1  
 | @dateForm [Optional]  
 | season 0-1  
 | @numberingOrg [Optional]  
 | @codeList [Optional]  
 | @listName [Optional]  
 | @listVersion [Optional]  
 | itemID 0-1  
 | **attachment 0-1**  
 | @uid [Optional]  
 | | fileName 0-1  
 | | @numberingOrg [Optional]  
 | | binaryObject 0-1  
 | | @format [Optional]  
 | | @mime [Optional]  
 | | @encoding [Optional]  
 | | @characterSet [Optional]  
 | | **externalReference 0-99**  
 | | | uri 1-1  
 | | | @isURL [Optional] [Default= true]  
 | | | mimeTypeCode 0-1  
 | | | formatCode 0-1  
 | | | encodingCode 0-1  
 | | | characterSetCode 0-1

**picture 0-99**

| pictureCode 0-1  
 | title 0-unbounded  
 | @In [Optional]  
 | description 0-unbounded  
 | @In [Optional]  
 | validityStart 0-1  
 | @dateForm [Optional]  
 | validityEnd 0-1  
 | @dateForm [Optional]  
 | alternativeText 0-unbounded  
 | @In [Optional]  
 | rendering 0-1  
 | resolution 0-1  
 | @resolutionType [Optional] [Default= dpi]  
 | width 0-1  
 | @um [Required]  
 | height 0-1  
 | @um [Required]  
 | nominalWidth 0-2  
 | @um [Optional]  
 | nominalHeight 0-2  
 | @um [Optional]  
 | pictureUse 0-1  
 | pictureQualifier 0-1  
 | **attachment 1-1**  
 | @uid [Optional]  
 | | fileName 0-1  
 | | @numberingOrg [Optional]  
 | | binaryObject 0-1  
 | | @format [Optional]  
 | | @mime [Optional]  
 | | @encoding [Optional]  
 | | @characterSet [Optional]  
 | | **externalReference 0-99**

|  |  |  |  |                                   |
|--|--|--|--|-----------------------------------|
|  |  |  |  | uri 1-1                           |
|  |  |  |  | @isURL [Optional] [Default= true] |
|  |  |  |  | mimeTypeCode 0-1                  |
|  |  |  |  | formatCode 0-1                    |
|  |  |  |  | encodingCode 0-1                  |
|  |  |  |  | characterSetCode 0-1              |
|  |  |  |  | note 0-99                         |
|  |  |  |  | @numberingOrg [Optional]          |
|  |  |  |  | @codeList [Optional]              |
|  |  |  |  | @noteLabel [Optional]             |
|  |  |  |  | brand 0-1                         |
|  |  |  |  | @numberingOrg [Optional]          |
|  |  |  |  | @codeList [Optional]              |
|  |  |  |  | @listName [Optional]              |
|  |  |  |  | @listVersion [Optional]           |
|  |  |  |  | productLine 0-1                   |
|  |  |  |  | @numberingOrg [Optional]          |
|  |  |  |  | @codeList [Optional]              |
|  |  |  |  | @listName [Optional]              |
|  |  |  |  | @listVersion [Optional]           |
|  |  |  |  | prodServName 0-1                  |
|  |  |  |  | operationalCode 0-9               |
|  |  |  |  | @numberingOrg [Optional]          |
|  |  |  |  | @codeList [Optional]              |
|  |  |  |  | @listName [Optional]              |
|  |  |  |  | @listVersion [Optional]           |
|  |  |  |  | @codeQualifier [Optional]         |
|  |  |  |  | <b>garmentCategory 0-1</b>        |
|  |  |  |  | @numberingOrg [Optional]          |
|  |  |  |  | artGroup 0-1                      |
|  |  |  |  | @numberingOrg [Optional]          |
|  |  |  |  | @codeList [Optional]              |
|  |  |  |  | @listName [Optional]              |
|  |  |  |  | @listVersion [Optional]           |
|  |  |  |  | artSubGroup 0-1                   |
|  |  |  |  | @numberingOrg [Optional]          |
|  |  |  |  | @codeList [Optional]              |
|  |  |  |  | @listName [Optional]              |
|  |  |  |  | @listVersion [Optional]           |
|  |  |  |  | artSex 0-1                        |
|  |  |  |  | @numberingOrg [Optional]          |
|  |  |  |  | @codeList [Optional]              |
|  |  |  |  | @listName [Optional]              |
|  |  |  |  | @listVersion [Optional]           |
|  |  |  |  | season 0-1                        |
|  |  |  |  | @numberingOrg [Optional]          |
|  |  |  |  | @codeList [Optional]              |
|  |  |  |  | @listName [Optional]              |
|  |  |  |  | @listVersion [Optional]           |
|  |  |  |  | <b>goodsClassification 0-9</b>    |
|  |  |  |  | macroClass 0-1                    |
|  |  |  |  | @numberingOrg [Optional]          |
|  |  |  |  | @codeList [Optional]              |
|  |  |  |  | @listName [Optional]              |
|  |  |  |  | @listVersion [Optional]           |
|  |  |  |  | class 0-1                         |
|  |  |  |  | @numberingOrg [Optional]          |
|  |  |  |  | @codeList [Optional]              |
|  |  |  |  | @listName [Optional]              |
|  |  |  |  | @listVersion [Optional]           |
|  |  |  |  | subClass 0-1                      |

| | | | @numberingOrg [Optional]  
| | | | @codeList [Optional]  
| | | | @listName [Optional]  
| | | | @listVersion [Optional]

| note 0-99

| | | | @numberingOrg [Optional]  
| | | | @codeList [Optional]  
| | | | @noteLabel [Optional]

| **fashionProd 1-1**

| additionalComponentCode 0-9  
| | | | @numberingOrg [Optional]  
| | | | @codeList [Optional]  
| | | | @listName [Optional]  
| | | | @listVersion [Optional]

- choose -

| | **yarnCode 1-2**

| | | @numberingOrg [Optional] [Default= CL]  
| | | art 1-1  
| | | | | @numberingOrg [Optional]  
| | | | | @codeList [Optional]  
| | | | | @listName [Optional]  
| | | | | @listVersion [Optional]  
| | | color 0-1  
| | | | | @numberingOrg [Optional]  
| | | | | @codeList [Optional]  
| | | | | @listName [Optional]  
| | | | | @listVersion [Optional]  
| | | added 0-9  
| | | | | @numberingOrg [Optional]  
| | | | | @addType [Optional]  
| | | description 0-unbounded  
| | | | | @ln [Optional]

- or -

| | **texCode 1-2**

| | | @numberingOrg [Optional]  
| | | art 1-1  
| | | | | @numberingOrg [Optional]  
| | | | | @codeList [Optional]  
| | | | | @listName [Optional]  
| | | | | @listVersion [Optional]  
| | | pattern 0-1  
| | | | | @numberingOrg [Optional]  
| | | | | @codeList [Optional]  
| | | | | @listName [Optional]  
| | | | | @listVersion [Optional]  
| | | color 0-1  
| | | | | @numberingOrg [Optional]  
| | | | | @codeList [Optional]  
| | | | | @listName [Optional]  
| | | | | @listVersion [Optional]  
| | | added 0-9  
| | | | | @numberingOrg [Optional]  
| | | | | @addType [Optional]  
| | | description 0-unbounded  
| | | | | @ln [Optional]

- or -

| | **acsCode 1-2**

| | | @numberingOrg [Optional]  
| | | art 1-1  
| | | | | @numberingOrg [Optional]  
| | | | | @codeList [Optional]

```

| | | | | @listName [Optional]
| | | | | @listVersion [Optional]
| | | | | pattern 0-1
| | | | | @numberingOrg [Optional]
| | | | | @codeList [Optional]
| | | | | @listName [Optional]
| | | | | @listVersion [Optional]
| | | | | color 0-1
| | | | | @numberingOrg [Optional]
| | | | | @codeList [Optional]
| | | | | @listName [Optional]
| | | | | @listVersion [Optional]
| | | | | added 0-9
| | | | | @numberingOrg [Optional]
| | | | | @addType [Optional]
| | | | | description 0-unbounded
| | | | | @ln [Optional]

```

- or -

```

| | | | | garmentPartCode 1-2
| | | | | @numberingOrg [Optional]
| | | | | gPart 1-1
| | | | | mod 1-1
| | | | | @numberingOrg [Optional]
| | | | | @codeList [Optional]
| | | | | @listName [Optional]
| | | | | @listVersion [Optional]
| | | | | fabric 0-1
| | | | | @numberingOrg [Optional]
| | | | | @codeList [Optional]
| | | | | @listName [Optional]
| | | | | @listVersion [Optional]
| | | | | color 0-1
| | | | | @numberingOrg [Optional]
| | | | | @codeList [Optional]
| | | | | @listName [Optional]
| | | | | @listVersion [Optional]
| | | | | added 0-19
| | | | | @numberingOrg [Optional]
| | | | | @addType [Optional]
| | | | | size 0-1
| | | | | @codeList [Optional]
| | | | | description 0-unbounded
| | | | | @ln [Optional]

```

- or -

```

| | | | | garmentCode 1-2
| | | | | @numberingOrg [Optional]

```

- choose -

```

| | | | | garmentCodeB 1-1
| | | | | @numberingOrg [Optional]
| | | | | mod 1-1
| | | | | @numberingOrg [Optional]
| | | | | @codeList [Optional]
| | | | | @listName [Optional]
| | | | | @listVersion [Optional]
| | | | | fabric 0-1
| | | | | @numberingOrg [Optional]
| | | | | @codeList [Optional]
| | | | | @listName [Optional]
| | | | | @listVersion [Optional]
| | | | | color 0-1
| | | | | @numberingOrg [Optional]

```

```

| | | | | @codeList [Optional]
| | | | | @listName [Optional]
| | | | | @listVersion [Optional]
| | | | | garmentVariant 0-9
| | | | | | variantType 1-1
| | | | | | | @numberingOrg [Optional]
| | | | | | | @codeList [Optional]
| | | | | | | @listName [Optional]
| | | | | | | @listVersion [Optional]
| | | | | | variantCode 1-1
| | | | | | | @numberingOrg [Optional]
| | | | | | | @codeList [Optional]
| | | | | | | @listName [Optional]
| | | | | | | @listVersion [Optional]
| | | | | drop 0-1
| | | | | | @codeList [Optional]
| | | | | size 0-1
| | | | | | @codeList [Optional]
| | | | | artGroup 0-1
| | | | | | @numberingOrg [Optional]
| | | | | | @codeList [Optional]
| | | | | | @listName [Optional]
| | | | | | @listVersion [Optional]
| | | | | added 0-9
| | | | | | @numberingOrg [Optional]
| | | | | | @addType [Optional]
| | | | | description 0-unbounded
| | | | | | @ln [Optional]

```

- or -

```

| | | | | garmentCodeA 1-1
| | | | | | art 1-1
| | | | | | | @numberingOrg [Optional]
| | | | | | | @codeList [Optional]
| | | | | | | @listName [Optional]
| | | | | | | @listVersion [Optional]
| | | | | | description 0-unbounded
| | | | | | @ln [Optional]

```

- end choose -

- end choose -

```

| | | | | csRange 0-unbounded
| | | | | | @numberingOrg [Optional]
| | | | | | @sizeSystemNat [Optional]
| | | | | | @sizeSystemSeg [Optional]
| | | | | | @sizeSystemBase [Optional]
| | | | | | @sizeSystemID [Optional]
| | | | | | color 0-1
| | | | | | | @numberingOrg [Optional]
| | | | | | | @codeList [Optional]
| | | | | | | @listName [Optional]
| | | | | | | @listVersion [Optional]
| | | | | | garmentVariant 0-9
| | | | | | | variantType 1-1
| | | | | | | | @numberingOrg [Optional]
| | | | | | | | @codeList [Optional]
| | | | | | | | @listName [Optional]
| | | | | | | | @listVersion [Optional]
| | | | | | | variantCode 1-1
| | | | | | | | @numberingOrg [Optional]
| | | | | | | | @codeList [Optional]
| | | | | | | | @listName [Optional]
| | | | | | | | @listVersion [Optional]

```

drop 0-1  
 @codeList [Optional]  
**sizeMatrix 1-1**  
   **sizeRow 1-99**  
     additionalComponentCode 0-9  
     @numberingOrg [Optional]  
     @codeList [Optional]  
     @listName [Optional]  
     @listVersion [Optional]  
     drop 0-1  
     @codeList [Optional]  
     size 1-1  
     @codeList [Optional]  
     qty 0-1  
     @um [Required]  
     **itemsList 0-1**  
       qualityLevel 0-1  
       @numberingOrg [Optional]  
       @codeList [Optional]  
       @listName [Optional]  
       @listVersion [Optional]  
       **itemIdentification 1-unbounded**  
       serialN 1-9  
       @numberingOrg [Optional]  
       @idQualifier [Optional]  
 note 0-unbounded  
 @numberingOrg [Optional]  
 @codeList [Optional]  
 @noteLabel [Optional]  
**composition 0-1**  
   **garmentCompos 0-1**  
     percCompos 1-99  
     @fibre [Required]  
   description 0-unbounded  
   @ln [Optional]  
 unitOfMeasure 0-99  
 @codeList [Optional]  
 @listName [Optional]  
 @listVersion [Optional]  
 @measureQualifier [Optional]  
**measureConversion 0-99**  
   unitOfSourceMeasure 1-1  
   @codeList [Optional]  
   @listName [Optional]  
   @listVersion [Optional]  
   @measureQualifier [Optional]  
   unitOfTargetMeasure 1-1  
   @codeList [Optional]  
   @listName [Optional]  
   @listVersion [Optional]  
   @measureQualifier [Optional]  
   conversionRate 1-1  
**productDim 0-1**  
   length 1-1  
   @um [Required]  
   width 0-1  
   @um [Required]  
   height 0-1  
   @um [Required]  
**packages 0-1**  
 @packageLevel [Optional]



```

- choose -
| | | | | packageText 1-1
- or -
| | | | | package 1-1
- end choose -
| | | | | packageModelCode 0-1
| | | | | @numberingOrg [Optional]
| | | | | description 0-unbounded
| | | | | @In [Optional]
| | | | | packageDim 0-1
| | | | | | length 1-1
| | | | | | @um [Required]
| | | | | | width 0-1
| | | | | | @um [Required]
| | | | | | height 0-1
| | | | | | @um [Required]
| | | | | | handlingChar 0-1
- choose -
| | | | | | yarnPack 0-1
| | | | | | | yarnReel 1-1
| | | | | | | @reelType [Required]
| | | | | | | @reelMat [Optional]
| | | | | | | | yarnReelD 0-1
| | | | | | | | @um [Required]
| | | | | | | | yarnReelH 0-1
| | | | | | | | @um [Required]
| | | | | | | | yarnConeAngle 0-1
| | | | | | | | yarnReelQty 0-2
| | | | | | | | @um [Required]
| | | | | | | | label 0-1
| | | | | | | | labelWrit 0-1
| | | | | | | | yarnInWrap 0-1
| | | | | | | | | yarnReelWrap 1-1
| | | | | | | | | label 0-1
| | | | | | | | | labelWrit 0-1
- choose -
| | | | | | | yarnOutWrapText 0-1
- or -
| | | | | | | yarnOutWrap 0-1
- end choose -
- or -
| | | | | | | piecePack 0-1
- choose -
| | | | | | | | piecePackText 1-1
- or -
| | | | | | | | | pieceInnWrap1 1-1
| | | | | | | | | pieceInnWrap2 0-1
| | | | | | | | | pieceOutWrap 0-1
- end choose -
- or -
| | | | | | | | acsPack 0-1
- choose -
| | | | | | | | | acsPackCode 1-1
- or -
| | | | | | | | | acsPackText 1-1
- end choose -
- or -
| | | | | | | | | garPack 0-1
- choose -
| | | | | | | | | | garPackCode 1-1
- or -

```

```

| | | | | garPackText 1-1
| | | | | - end choose -
| | | | | - end choose -
| | | | | | sortableIndicator 0-1
| | | | | | stackabilityLevel 0-1
| | | | | | handlingType 0-1
| | | | | | @In [Optional]
| | | | | | volume 0-1
| | | | | | @um [Required]
| | | | | | netWeight 0-1
| | | | | | @um [Required]
| | | | | | grossWeight 0-1
| | | | | | @um [Required]
| | | | | | note 0-99
| | | | | | @numberingOrg [Optional]
| | | | | | @codeList [Optional]
| | | | | | @noteLabel [Optional]
| | | | | itemsPerPackage 0-1
| | | | | @um [Required]
| | | | | minItemsPerPackage 0-1
| | | | | @um [Required]
| | | | | fillingCriterion 0-9
| | | | | @progr [Optional]
| | | | | packageQty 0-1
| | | | | packageN 0-unbounded
| | | | | @numberingOrg [Optional]
| | | | | @packageContainerN [Optional]
| | | | | EPClist 0-1
| | | | | | EPC 1-unbounded
| | | | | | @numberingOrg [Optional]
| | | | | | @TID [Optional]
| | | | | extendedDescription 0-unbounded
| | | | | @In [Optional]
| | | | | marketPrice 0-unbounded
| | | | | | catalogPrice 1-1
| | | | | | @um [Required]
| | | | | | @minQty [Optional]
| | | | | | @currency [Optional]
| | | | | | @garmentMarket [Optional]
| | | | | | @maxQty [Optional]
| | | | | | allowanceCharge 0-9
| | | | | | @um [Optional]
| | | | | | @VAT [Optional]
| | | | | | @minQty [Optional]
| | | | | | @currency [Optional]
| | | | | | @maxQty [Optional]
| | | | | - choose -
| | | | | | AC_category 1-1
| | | | | - or -
| | | | | | AC_categoryText 1-1
| | | | | - end choose -
| | | | | - choose -
| | | | | | AC_percent 1-1
| | | | | - or -
| | | | | | AC_amount 1-1
| | | | | - end choose -
| | | | | | dtScheme 0-1
| | | | | | @taxType [Required]
| | | | | | | taxCategory 0-1
| | | | | | | taxRate 0-1
| | | | | | | legalRef 0-1

```

```

| | | | | @codeList [Required]
| | | | | note 0-99
| | | | | @numberingOrg [Optional]
| | | | | @codeList [Optional]
| | | | | @noteLabel [Optional]
| | | | | geographicArea 0-9
| | | | | - choose -
| | | | | | geographicAreaCode 1-1
| | | | | - or -
| | | | | | geographicAreaText 1-1
| | | | | - end choose -
| | | | | allowanceCharge 0-9
| | | | | @um [Optional]
| | | | | @VAT [Optional]
| | | | | @minQty [Optional]
| | | | | @currency [Optional]
| | | | | @maxQty [Optional]
| | | | | - choose -
| | | | | | AC_category 1-1
| | | | | - or -
| | | | | | AC_categoryText 1-1
| | | | | - end choose -
| | | | | - choose -
| | | | | | AC_percent 1-1
| | | | | - or -
| | | | | | AC_amount 1-1
| | | | | - end choose -
| | | | | dtScheme 0-1
| | | | | @taxType [Required]
| | | | | taxCategory 0-1
| | | | | taxRate 0-1
| | | | | legalRef 0-1
| | | | | @codeList [Required]
| | | | | note 0-99
| | | | | @numberingOrg [Optional]
| | | | | @codeList [Optional]
| | | | | @noteLabel [Optional]
| | | | | garComInfo 0-1
| | | | | @endUse [Optional]
| | | | | season 0-1
| | | | | @numberingOrg [Optional]
| | | | | @codeList [Optional]
| | | | | @listName [Optional]
| | | | | @listVersion [Optional]
| | | | | brand 0-1
| | | | | @numberingOrg [Optional]
| | | | | @codeList [Optional]
| | | | | @listName [Optional]
| | | | | @listVersion [Optional]
| | | | | productLine 0-1
| | | | | @numberingOrg [Optional]
| | | | | @codeList [Optional]
| | | | | @listName [Optional]
| | | | | @listVersion [Optional]
| | | | | project 0-1
| | | | | operationalCode 0-19
| | | | | @numberingOrg [Optional]
| | | | | @codeList [Optional]
| | | | | @listName [Optional]
| | | | | @listVersion [Optional]
| | | | | @codeQualifier [Optional]

```

|  |  |  |  |                          |
|--|--|--|--|--------------------------|
|  |  |  |  | deliveryDate 0-1         |
|  |  |  |  | @dateForm [Optional]     |
|  |  |  |  | specDate 0-1             |
|  |  |  |  | @dateForm [Optional]     |
|  |  |  |  | note 0-99                |
|  |  |  |  | @numberingOrg [Optional] |
|  |  |  |  | @codeList [Optional]     |
|  |  |  |  | @noteLabel [Optional]    |
|  |  |  |  | <b>dtScheme 0-1</b>      |
|  |  |  |  | @taxType [Required]      |
|  |  |  |  | taxCategory 0-1          |
|  |  |  |  | taxRate 0-1              |
|  |  |  |  | legalRef 0-1             |
|  |  |  |  | @codeList [Required]     |
|  |  |  |  | note 0-99                |
|  |  |  |  | @numberingOrg [Optional] |
|  |  |  |  | @codeList [Optional]     |
|  |  |  |  | @noteLabel [Optional]    |
|  |  |  |  | note 0-99                |
|  |  |  |  | @numberingOrg [Optional] |
|  |  |  |  | @codeList [Optional]     |
|  |  |  |  | @noteLabel [Optional]    |
|  |  |  |  | note 0-99                |
|  |  |  |  | @numberingOrg [Optional] |
|  |  |  |  | @codeList [Optional]     |
|  |  |  |  | @noteLabel [Optional]    |

## 2.2 Detailed description of document elements

Following tables show all elements (complex and simple) used in this document. Description includes: 1) element's information: xml tag, name, brief description, data type and syntax constraints; 2) information about use of the element in a particular position in the document: xpath and possible associated notes.

### 2.2.1 Complex elements (Aggregate Business Information Entities)

Complex elements are those elements whose content is composed of other elements (childs). Complex elements are alphabetically ordered.

|                        |   |
|------------------------|---|
| <b>acsCode</b>         | full codification identifying an accessory product usually coupled with garment or other fashion product<br>(XPath FASCatalog/FCbody/FCgroup/FCitem/fashionProd/acsCode) 1-2<br>- note: <i>this element can have two instances only if the numbering organisations are different</i>  |
| <b>acsPack</b>         | type of wrapping or packing of the accessory<br>(XPath FASCatalog/FCbody/FCgroup/FCitem/packages/handlingChar/acsPack) 0-1  |
| <b>allowanceCharge</b> | Allowances and Charges related to an Order or a contract<br>(XPath FASCatalog/terms/allowanceCharge) 0-9<br>(XPath FASCatalog/FCbody/FCgroup/FCitem/allowanceCharge) 0-9<br>- note: <i>Charges and allowances to be applied to all prices indicated for this item</i><br>(XPath FASCatalog/FCbody/FCgroup/allowanceCharge) 0-9<br>- note: <i>It declares conditions applicable to all the group</i><br>(XPath FASCatalog/FCbody/FCgroup/FCitem/marketPrice/allowanceCharge) 0-9<br>- note: <i>Allowances and charges to be applied to the price</i> |
| <b>attachment</b>      | an attached document. An attachment can refer to an external document or be included with the document being exchanged<br>(XPath FASCatalog/FCheader/picture/attachment) 1-1<br>(XPath FASCatalog/FCbody/FCgroup/refDoc/attachment) 0-1<br>(XPath FASCatalog/FCbody/FCgroup/FCitem/picture/attachment) 1-1<br>(XPath FASCatalog/FCbody/FCgroup/FCitem/refDoc/attachment) 0-1<br>(XPath FASCatalog/FCbody/FCgroup/picture/attachment) 1-1<br>(XPath FASCatalog/FCheader/refDoc/attachment) 0-1   |
| <b>buyer</b>           | details of the Buyer (party that buys the good or service that is object of the current collaborative process)<br>- base type: Nad,<br>(XPath FASCatalog/FCheader/buyer) 0-1  |
| <b>composition</b>     | Composition of a garment product or of a part of it<br>(XPath FASCatalog/FCbody/FCgroup/FCitem/composition) 0-1   |
| <b>csRange</b>         | range of color-size for a fashion article<br>(XPath FASCatalog/FCbody/FCgroup/FCitem/fashionProd/csRange) 0-unbounded   |
| <b>dtScheme</b>        | set of data usable to declare the duty or tax applied<br>(XPath FASCatalog/FCbody/FCgroup/allowanceCharge/dtScheme) 0-1<br>(XPath FASCatalog/FCbody/FCgroup/FCitem/allowanceCharge/dtScheme) 0-1<br>(XPath FASCatalog/FCbody/FCgroup/FCitem/dtScheme) 0-1<br>(XPath FASCatalog/terms/allowanceCharge/dtScheme) 0-1<br>(XPath FASCatalog/FCbody/FCgroup/FCitem/marketPrice/allowanceCharge/dtScheme) 0-1   |
| <b>EPClist</b>         | list of identifiers used for tracing a physical item with RFID technology<br>(XPath FASCatalog/FCbody/FCgroup/FCitem/packages/EPClist) 0-1<br>- note: <i>this element is DEPRECATED, please use the specific elements</i>   |

|                          |  |
|--------------------------|--|
| <b>externalReference</b> | <p>details about an external object, such as a document stored at a remote location</p> <p>(XPath FASCatalog/FCheader/picture/attachment/externalReference) 0-99<br/> (XPath FASCatalog/FCheader/refDoc/attachment/externalReference) 0-99<br/> (XPath FASCatalog/FCbody/FCgroup/picture/attachment/externalReference) 0-99<br/> (XPath FASCatalog/FCbody/FCgroup/refDoc/attachment/externalReference) 0-99<br/> (XPath FASCatalog/FCbody/FCgroup/FCitem/refDoc/attachment/externalReference) 0-99<br/> (XPath FASCatalog/FCbody/FCgroup/FCitem/picture/attachment/externalReference) 0-99</p> |
| <b>fashionProd</b>       | <p>identification of the fashion product or its part (fabric, yarn, accessory, final product or part of it, ...).</p> <p>(XPath FASCatalog/FCbody/FCgroup/FCitem/fashionProd) 1-1</p> <p>- note: <i>the csRange element in fashionProd inside FC Item should only be used to indicate which sizes and colors are available, not the quantities.</i></p>  |
| <b>FCbody</b>            | <p>body of the document FASHION CATALOGUE</p> <p>(XPath FASCatalog/FCbody) 1-1</p>   |
| <b>FCgroup</b>           | <p>Articles grouping of fashion products or their parts for catalogue.</p> <p>(XPath FASCatalog/FCbody/FCgroup) 1-unbounded</p>  |
| <b>FCheader</b>          | <p>header of the document FASHION CATALOGUE</p> <p>(XPath FASCatalog/FCheader) 1-1</p>   |
| <b>FCitem</b>            | <p>Details of a fashion product or component (i.e. fabric, yarn, accessory) for fashion catalogue</p> <p>(XPath FASCatalog/FCbody/FCgroup/FCitem) 0-unbounded</p> <p>- note: <i>More articles in the same group o products</i></p>   |
| <b>garComInfo</b>        | <p>miscellaneous commercial information.</p> <p>(XPath FASCatalog/FCbody/FCgroup/garComInfo) 0-1</p> <p>- note: <i>It declares conditions applicable to all the group</i></p> <p>(XPath FASCatalog/FCbody/FCgroup/FCitem/garComInfo) 0-1<br/> (XPath FASCatalog/garComInfo) 0-1</p>  |
| <b>garmentCategory</b>   | <p>classification of a garment article</p> <p>(XPath FASCatalog/FCbody/FCgroup/FCitem/garmentCategory) 0-1</p>   |
| <b>garmentCode</b>       | <p>codification of the garment product</p> <p>(XPath FASCatalog/FCbody/FCgroup/FCitem/fashionProd/garmentCode) 1-2</p> <p>- note: <i>this element can have two instances only if the numbering organisations are different</i></p>   |
| <b>garmentCodeA</b>      | <p>codification of the garment product- type A</p> <p>(XPath FASCatalog/FCbody/FCgroup/FCitem/fashionProd/garmentCode/garmentCodeA) 1-1</p> <p>- note: <i>here the barcode EAN-13 or EAN-8 should be specified</i></p>   |
| <b>garmentCodeB</b>      | <p>codification of the garment product - type B</p> <p>(XPath FASCatalog/FCbody/FCgroup/FCitem/fashionProd/garmentCode/garmentCodeB) 1-1</p>   |
| <b>garmentCompos</b>     | <p>Quantitative composition of a garment product (of its part)</p> <p>(XPath FASCatalog/FCbody/FCgroup/FCitem/composition/garmentCompos) 0-1</p>   |
| <b>garmentPartCode</b>   | <p>codification of the component or part of a fashion article</p> <p>(XPath FASCatalog/FCbody/FCgroup/FCitem/fashionProd/garmentPartCode) 1-2</p> <p>- note: <i>this element can have two instances only if the numbering organisations are different</i></p>  |
| <b>garmentVariant</b>    | <p>garment product variant</p> <p>(XPath FASCatalog/FCbody/FCgroup/FCitem/fashionProd/csRange/garmentVariant) 0-9</p> <p>- note: <i>used only if not already specified in the article code</i></p>   |

|                            |   |
|----------------------------|---|
|                            | (XPath FASCatalog/FCbody/FCgroup/FCitem/fashionProd/garmentCode/garmentCodeB/garmentVariant) 0-9  |
| <b>garPack</b>             | the packaging mode of the item or a part of it.<br>(XPath FASCatalog/FCbody/FCgroup/FCitem/packages/handlingChar/garPack) 0-1   |
| <b>geographicArea</b>      | identification of a geographic area<br>- base type: string,<br>(XPath FASCatalog/FCbody/FCgroup/FCitem/marketPrice/geographicArea) 0-9<br>- note: <i>geographical area to which the indicated price applies (one or more)</i>   |
| <b>goodsClassification</b> | goods classification of the item.<br>(XPath FASCatalog/FCbody/FCgroup/FCitem/garmentCategory/goodsClassification) 0-9   |
| <b>handlingChar</b>        | features of an item (item or package) useful for its transport and warehouse management.<br>(XPath FASCatalog/FCbody/FCgroup/FCitem/packages/handlingChar) 0-1<br>- note: <i>in this case the characteristics are related to the package.</i>   |
| <b>insPayment</b>          | payment details for payment by installments<br>(XPath FASCatalog/terms/insPayment) 0-5<br>- note: <i>excluded the case of offers, this set of data is alternative to payment set and must be iterated for each payment installment</i>  |
| <b>itemIdentification</b>  | serial identification of a product unit<br>(XPath FASCatalog/FCbody/FCgroup/FCitem/fashionProd/csRange/sizeMatrix/sizeRow/itemsList/itemIdentification) 1-unbounded<br>- note: <i>identification of the single product unit contained in the list</i>   |
| <b>itemsList</b>           | list of the single product units<br>(XPath FASCatalog/FCbody/FCgroup/FCitem/fashionProd/csRange/sizeMatrix/sizeRow/itemsList) 0-1<br>- note: <i>the usage in this position is alternative to its usage within the document line element</i>   |
| <b>marketPrice</b>         | price shown for a specific market catalogue<br>(XPath FASCatalog/FCbody/FCgroup/FCitem/marketPrice) 0-unbounded   |
| <b>measureConversion</b>   | Details to convert two different unit of measure.<br>(XPath FASCatalog/FCbody/FCgroup/FCitem/measureConversion) 0-99  |
| <b>packageDim</b>          | dimensions of a transport package<br>(XPath FASCatalog/FCbody/FCgroup/FCitem/packages/packageDim) 0-1   |
| <b>packages</b>            | describes the composition of the transport packaging. Each element corresponds to a type of package: type, quantity, hierarchic level, list of identifiers of the single packages<br>(XPath FASCatalog/FCbody/FCgroup/FCitem/packages) 0-1<br>- note: <i>Use to indicate the packaging of the product</i>   |
| <b>payment</b>             | payment details for payment all in one<br>(XPath FASCatalog/terms/payment) 0-5<br>- note: <i>excluded the case of offers, this set of data is alternative to insPayment, it can be iterated to specify alternative terms of payment (e.g.: 60 days or 30 days with 3% discount)</i>   |
| <b>picture</b>             | picture; image features and its representation or link to it<br>- base type: ,<br>(XPath FASCatalog/FCbody/FCgroup/FCitem/picture) 0-99<br>(XPath FASCatalog/FCbody/FCgroup/picture) 0-99<br>- note: <i>Images associated to the whole group</i><br>(XPath FASCatalog/FCheader/picture) 0-9<br>- note: <i>Images associated to the whole catalogue (i.e. cover)</i> |
| <b>piecePack</b>           | type of wrapping or packing of the fabric pieces  |

|                   |  |
|-------------------|--|
|                   | (XPath FASCatalog/FCbody/FCgroup/FCitem/packages/handlingChar/piecePack) 0-1   |
| <b>productDim</b> | Dimensions of an object.<br>(XPath FASCatalog/FCbody/FCgroup/FCitem/productDim) 0-1<br>- note: <i>Dimension of the article</i>   |
| <b>refDoc</b>     | identification of a document and of an item thereof, to which the message makes reference<br>(XPath FASCatalog/FCbody/FCgroup/refDoc) 0-9<br>(XPath FASCatalog/FCheader/refDoc) 0-9<br>(XPath FASCatalog/FCbody/FCgroup/FCitem/refDoc) 0-9 |
| <b>sizeMatrix</b> | size matrix of an apparel product<br>(XPath FASCatalog/FCbody/FCgroup/FCitem/fashionPro/csRange/sizeMatrix) 1-1  |
| <b>sizeRow</b>    | size matrix row of an apparel product<br>(XPath FASCatalog/FCbody/FCgroup/FCitem/fashionPro/csRange/sizeMatrix/sizeRow) 1-99   |
| <b>supplier</b>   | details of the Supplier (party that supplies the good or service that is object of the current collaborative process)<br>- base type: Nad,<br>(XPath FASCatalog/FCheader/supplier) 1-1   |
| <b>terms</b>      | details of the commercial obligations for payment and delivery<br>(XPath FASCatalog/terms) 0-1   |
| <b>texCode</b>    | full codification of the textile product<br>(XPath FASCatalog/FCbody/FCgroup/FCitem/fashionPro/texCode) 1-2<br>- note: <i>this element can have two instances only if the numbering organisations are different</i>                        |
| <b>thirdParty</b> | details of the Third Party, different from Buyer or Supplier<br>- base type: Nad,<br>(XPath FASCatalog/FCheader/thirdParty) 0-5  |
| <b>trade</b>      | general terms of trade for the specified supply<br>(XPath FASCatalog/terms/trade) 0-1  |
| <b>transInfo</b>  | details of transport: mode, carrier and delivery place<br>(XPath FASCatalog/terms/transInfo) 0-5   |
| <b>yarnCode</b>   | full codification of a yarn product<br>(XPath FASCatalog/FCbody/FCgroup/FCitem/fashionPro/yarnCode) 1-2<br>- note: <i>this element can have two instances only if the numbering organisations are different</i>                            |
| <b>yarnInWrap</b> | details specifying the inner wrapping of a yarn product<br>(XPath FASCatalog/FCbody/FCgroup/FCitem/packages/handlingChar/yarnPack/yarnInWrap) 0-1  |
| <b>yarnPack</b>   | details of type of presentation used for the yarn<br>(XPath FASCatalog/FCbody/FCgroup/FCitem/packages/handlingChar/yarnPack) 0-1   |
| <b>yarnReel</b>   | details of the packaging of a yarn product (bobbin and reel,..)<br>(XPath FASCatalog/FCbody/FCgroup/FCitem/packages/handlingChar/yarnPack/yarnReel) 1-1  |

### 2.2.2 Simple elements (Basic Business Information Entities)

Simple elements are those elements whose content is characterized by a data type plus a domain of possible values. Simple elements are alphabetically ordered.



|                         |   |
|-------------------------|---|
| AC_amount               | <p>amount of an Allowance or Charge</p> <p>- base type: decimal, fraction digits: 2,</p> <p>(XPath FASCatalog/FCbody/FCgroup/allowanceCharge/AC_amount) 1-1</p> <p>(XPath FASCatalog/terms/allowanceCharge/AC_amount) 1-1</p> <p>(XPath FASCatalog/FCbody/FCgroup/FCitem/allowanceCharge/AC_amount) 1-1</p> <p>(XPath FASCatalog/FCbody/FCgroup/FCitem/marketPrice/allowanceCharge/AC_amount) 1-1</p>   |
| AC_category             | <p>coded specification of an Allowance or Charge</p> <p>- base type: string, cod. table: T41</p> <p><a href="http://www.ebiz.enea.it/moda-ml/repository/codelist/draft/gc_T41.xml">http://www.ebiz.enea.it/moda-ml/repository/codelist/draft/gc_T41.xml</a></p> <p>(XPath FASCatalog/terms/allowanceCharge/AC_category) 1-1</p> <p>(XPath FASCatalog/FCbody/FCgroup/FCitem/allowanceCharge/AC_category) 1-1</p> <p>(XPath FASCatalog/FCbody/FCgroup/allowanceCharge/AC_category) 1-1</p> <p>(XPath FASCatalog/FCbody/FCgroup/FCitem/marketPrice/allowanceCharge/AC_category) 1-1</p>  |
| AC_categoryText         | <p>free text description of an Allowance or Charge</p> <p>- base type: string, max length: 250,</p> <p>(XPath FASCatalog/FCbody/FCgroup/FCitem/marketPrice/allowanceCharge/AC_categoryText) 1-1</p> <p>(XPath FASCatalog/FCbody/FCgroup/FCitem/allowanceCharge/AC_categoryText) 1-1</p> <p>(XPath FASCatalog/FCbody/FCgroup/allowanceCharge/AC_categoryText) 1-1</p> <p>(XPath FASCatalog/terms/allowanceCharge/AC_categoryText) 1-1</p>  |
| AC_percent              | <p>amount of an Allowance or Charge as a percentage</p> <p>- base type: decimal, max inclusive: 100, fraction digits: 2,</p> <p>(XPath FASCatalog/FCbody/FCgroup/FCitem/allowanceCharge/AC_percent) 1-1</p> <p>(XPath FASCatalog/terms/allowanceCharge/AC_percent) 1-1</p> <p>(XPath FASCatalog/FCbody/FCgroup/allowanceCharge/AC_percent) 1-1</p> <p>(XPath FASCatalog/FCbody/FCgroup/FCitem/marketPrice/allowanceCharge/AC_percent) 1-1</p>   |
| acsPackCode             | <p>code specifying the type of wrapping or packing used for the accessory</p> <p>- base type: string,</p> <p>(XPath FASCatalog/FCbody/FCgroup/FCitem/packages/handlingChar/acsPack/acsPackCode) 1-1</p>   |
| acsPackText             | <p>free text specifying the type of wrapping or packing used for the accessory</p> <p>- base type: string, max length: 250,</p> <p>(XPath FASCatalog/FCbody/FCgroup/FCitem/packages/handlingChar/acsPack/acsPackText) 1-1</p>   |
| added                   | <p>additional code of the product (complementing the formers)</p> <p>- base type: string, max length: 80,</p> <p>(XPath FASCatalog/FCbody/FCgroup/FCitem/fashionProd/garmentCode/garmentCodeB/added) 0-9</p> <p>(XPath FASCatalog/FCbody/FCgroup/FCitem/fashionProd/garmentPartCode/added) 0-19</p> <p>(XPath FASCatalog/FCbody/FCgroup/FCitem/fashionProd/yarnCode/added) 0-9</p> <p>- note: <i>here an additional codification (see table T44) can be specified</i></p> <p>(XPath FASCatalog/FCbody/FCgroup/FCitem/fashionProd/acsCode/added) 0-9</p> <p>- note: <i>here an additional codification (see table T44) can be specified</i></p> <p>(XPath FASCatalog/FCbody/FCgroup/FCitem/fashionProd/texCode/added) 0-9</p> <p>- note: <i>here an additional codification (see table T44) can be specified</i></p> |
| additionalComponentCode | <p>an additional code to identify a fashion product or a part of it (it is a way to codify the item, but it is not one of the codes to identify it). It is not a serial identifier.</p> <p>- base type: string,</p> <p>(XPath FASCatalog/FCbody/FCgroup/FCitem/fashionProd/csRange/sizeMatrix/sizeRow/additionalComponentCode) 0-9</p>  |

|                      |  |
|----------------------|--|
|                      | <p>(XPath FASCatalog/FCbody/FCgroup/FCitem/fashionProd/additionalComponentCode) 0-9</p> <p>- note: <i>If the code is related to the size, the (non serial) unique product code should not be here (use the same elemnt within sizeRow).</i></p>  |
| additionalIdentifier | <p>additional identification code of a Party, for example customs registries or others</p> <p>- base type: string, max length: 15,</p> <p>(XPath FASCatalog/FCheader/buyer/additionalIdentifier) 0-9</p> <p>- note: <i>identifiers for example for exports, such as MID (Manufacturer Identification Code), EORI (E.O.R.I. - Economic Operator Registration and Identification)</i></p> <p>(XPath FASCatalog/FCheader/supplier/additionalIdentifier) 0-9</p> <p>- note: <i>identifiers for example for exports, such as MID (Manufacturer Identification Code), EORI (E.O.R.I. - Economic Operator Registration and Identification)</i></p>  |
| @addType             | <p>qualifier of the additional coding of a product</p> <p>- base type: string, cod. table: T44</p> <p><a href="http://www.ebiz.enea.it/moda-ml/repository/codelist/draft/gc_T44.xml">http://www.ebiz.enea.it/moda-ml/repository/codelist/draft/gc_T44.xml</a></p> <p>(XPath FASCatalog/FCbody/FCgroup/FCitem/fashionProd/yarnCode/added/@addType) [Optional]</p> <p>- nota: <i>addType allows the clarification of the meaning of the added element content; it is strongly suggested to use it always.</i></p> <p>(XPath FASCatalog/FCbody/FCgroup/FCitem/fashionProd/acsCode/added/@addType) [Optional]</p> <p>- nota: <i>addType allows the clarification of the meaning of the added element content; it is strongly suggested to use it always.</i></p> <p>(XPath FASCatalog/FCbody/FCgroup/FCitem/fashionProd/garmentPartCode/added/@addType) [Optional]</p> <p>- nota: <i>addType allows the clarification of the meaning of the added element content; it is strongly suggested to use it always.</i></p> <p>(XPath FASCatalog/FCbody/FCgroup/FCitem/fashionProd/garmentCode/garmentCodeB/added/@addType) [Optional]</p> <p>- nota: <i>addType allows the clarification of the meaning of the added element content; it is strongly suggested to use it always.</i></p> <p>(XPath FASCatalog/FCbody/FCgroup/FCitem/fashionProd/texCode/added/@addType) [Optional]</p> <p>- nota: <i>addType allows the clarification of the meaning of the added element content; it is strongly suggested to use it always.</i></p> |
| alternativeText      | <p>alternative text of the picture</p> <p>- base type: string, max length: 255,</p> <p>(XPath FASCatalog/FCbody/FCgroup/picture/alternativeText) 0-unbounded</p> <p>- note: <i>Only one instance of this element for each different value of 'ln' attribute (language)</i></p> <p>(XPath FASCatalog/FCheader/picture/alternativeText) 0-unbounded</p> <p>- note: <i>Only one instance of this element for each different value of 'ln' attribute (language)</i></p> <p>(XPath FASCatalog/FCbody/FCgroup/FCitem/picture/alternativeText) 0-unbounded</p> <p>- note: <i>Only one instance of this element for each different value of 'ln' attribute (language)</i></p>  |
| art                  | <p>article number of the product</p> <p>- base type: string, max length: 80,</p> <p>(XPath FASCatalog/FCbody/FCgroup/FCitem/fashionProd/garmentCode/garmentCodeA/art) 1-1</p> <p>(XPath FASCatalog/FCbody/FCgroup/FCitem/fashionProd/texCode/art) 1-1</p> <p>- note: <i>can be used either for the base-article (excluding pattern/colour) or for the SKU</i></p> <p>(XPath FASCatalog/FCbody/FCgroup/FCitem/fashionProd/yarnCode/art) 1-1</p> <p>(XPath FASCatalog/FCbody/FCgroup/FCitem/fashionProd/acsCode/art) 1-1</p>   |

|                  |  |
|------------------|--|
| artGroup         | code identifying a class of products<br>- base type: string, max length: 40,<br>(XPath FASCatalog/FCbody/FCgroup/FCitem/garmentCategory/artGroup) 0-1<br>(XPath FASCatalog/FCbody/FCgroup/FCitem/fashionProd/garmentCode/garmentCodeB/artGroup) 0-1<br>(XPath FASCatalog/FCbody/FCgroup/artGroup) 0-1  |
| artGroupName     | description of a class of products<br>- base type: string, max length: 80,<br>(XPath FASCatalog/FCbody/FCgroup/artGroupName) 0-1   |
| artSex           | code identifying the sex for which a fashion product is intended<br>- base type: string, max length: 15,<br>(XPath FASCatalog/FCbody/FCgroup/FCitem/garmentCategory/artSex) 0-1  |
| artSubGroup      | code identifying a sub-class of products<br>- base type: string, max length: 40,<br>(XPath FASCatalog/FCbody/FCgroup/FCitem/garmentCategory/artSubGroup) 0-1   |
| binaryObject     | a binary large object containing an attached document<br>- base type: base64Binary,<br>(XPath FASCatalog/FCbody/FCgroup/FCitem/picture/attachment/binaryObject) 0-1<br>(XPath FASCatalog/FCbody/FCgroup/FCitem/refDoc/attachment/binaryObject) 0-1<br>(XPath FASCatalog/FCbody/FCgroup/refDoc/attachment/binaryObject) 0-1<br>(XPath FASCatalog/FCheader/picture/attachment/binaryObject) 0-1<br>(XPath FASCatalog/FCheader/refDoc/attachment/binaryObject) 0-1<br>(XPath FASCatalog/FCbody/FCgroup/picture/attachment/binaryObject) 0-1   |
| brand            | A brand name.<br>- base type: string,<br>(XPath FASCatalog/garComInfo/brand) 0-1<br>(XPath FASCatalog/FCbody/FCgroup/garComInfo/brand) 0-1<br>(XPath FASCatalog/FCbody/FCgroup/FCitem/garComInfo/brand) 0-1<br>(XPath FASCatalog/FCbody/FCgroup/FCitem/brand) 0-1  |
| carrier          | identification of the transport carrier<br>- base type: string, max length: 40,<br>(XPath FASCatalog/terms/transInfo/carrier) 0-1  |
| catalogPrice     | price shown in the Supplier's Catalogue<br>- base type: decimal, fraction digits: 2,<br>(XPath FASCatalog/FCbody/FCgroup/FCitem/marketPrice/catalogPrice) 1-1<br>- note: <i>Unit price not including allowances and charges</i>  |
| @characterSet    | the character set of the binary object if the mime type is text<br>- base type: normalizedString,<br>(XPath FASCatalog/FCbody/FCgroup/picture/attachment/binaryObject/@characterSet) [Optional]<br>(XPath FASCatalog/FCbody/FCgroup/refDoc/attachment/binaryObject/@characterSet) [Optional]<br>(XPath FASCatalog/FCbody/FCgroup/FCitem/picture/attachment/binaryObject/@characterSet) [Optional]<br>(XPath FASCatalog/FCbody/FCgroup/FCitem/refDoc/attachment/binaryObject/@characterSet) [Optional]<br>(XPath FASCatalog/FCheader/refDoc/attachment/binaryObject/@characterSet) [Optional]<br>(XPath FASCatalog/FCheader/picture/attachment/binaryObject/@characterSet) [Optional] |
| characterSetCode | the character set of an external document<br>- base type: normalizedString,<br>(XPath FASCatalog/FCbody/FCgroup/FCitem/picture/attachment/externalReference/characterSetCode) 0-1  |

|           |   |
|-----------|---|
|           | <p>(XPath FASCatalog/FCheader/picture/attachment/externalReference/characterSetCode) 0-1</p> <p>(XPath FASCatalog/FCbody/FCgroup/picture/attachment/externalReference/characterSetCode) 0-1</p> <p>(XPath FASCatalog/FCheader/refDoc/attachment/externalReference/characterSetCode) 0-1</p> <p>(XPath FASCatalog/FCbody/FCgroup/FCitem/refDoc/attachment/externalReference/characterSetCode) 0-1</p> <p>(XPath FASCatalog/FCbody/FCgroup/refDoc/attachment/externalReference/characterSetCode) 0-1</p>  |
| city      | <p>name of the city (town, village)</p> <p>- base type: string, max length: 40,</p> <p>(XPath FASCatalog/FCheader/buyer/city) 0-1</p> <p>(XPath FASCatalog/FCheader/supplier/city) 0-1</p> <p>(XPath FASCatalog/FCheader/thirdParty/city) 0-1</p>   |
| class     | <p>a code indicating the category (macro-class, class or sub-class) of a commodity classification system the article belongs to.</p> <p>- base type: string,</p> <p>(XPath FASCatalog/FCbody/FCgroup/FCitem/garmentCategory/goodsClassification/class) 0-1</p>  |
| @codeList | <p>it specifies the URL where the list of codes used to make an instance of the element can be found</p> <p>- base type: string, max length: 255,</p> <p>(XPath FASCatalog/FCbody/FCgroup/FCitem/fashionProd/acsCode/pattern/@codeList) [Optional]</p> <p>- nota: <i>this attribute should be ALTERNATIVE to the others</i></p> <p>(XPath FASCatalog/FCbody/FCgroup/FCitem/fashionProd/csRange/drop/@codeList) [Optional]</p> <p>(XPath FASCatalog/FCbody/FCgroup/FCitem/allowanceCharge/dtScheme/legalRef/@codeList) [Required]</p> <p>(XPath FASCatalog/FCbody/FCgroup/FCitem/garComInfo/brand/@codeList) [Optional]</p> <p>(XPath FASCatalog/FCbody/FCgroup/FCitem/garmentCategory/artSubGroup/@codeList) [Optional]</p> <p>- nota: <i>this attribute should be ALTERNATIVE to the others</i></p> <p>(XPath FASCatalog/garComInfo/productLine/@codeList) [Optional]</p> <p>(XPath FASCatalog/FCbody/FCgroup/FCitem/fashionProd/garmentCode/garmentCodeA/art/@codeList) [Optional]</p> <p>- nota: <i>this attribute should be ALTERNATIVE to the others</i></p> <p>(XPath FASCatalog/FCbody/FCgroup/FCitem/fashionProd/acsCode/art/@codeList) [Optional]</p> <p>- nota: <i>this attribute should be ALTERNATIVE to the others</i></p> <p>(XPath FASCatalog/garComInfo/season/@codeList) [Optional]</p> <p>(XPath FASCatalog/terms/allowanceCharge/dtScheme/note/@codeList) [Optional]</p> <p>- nota: <i>must be used to provide (URL) the list of codes used in "noteLabel"</i></p> <p>(XPath FASCatalog/FCbody/FCgroup/FCitem/fashionProd/csRange/garmentVariant/variantCode/@codeList) [Optional]</p> <p>- nota: <i>this attribute should be ALTERNATIVE to the others</i></p> <p>(XPath FASCatalog/FCbody/FCgroup/picture/note/@codeList) [Optional]</p> <p>- nota: <i>must be used to provide (URL) the list of codes used in "noteLabel"</i></p> <p>(XPath FASCatalog/FCbody/FCgroup/FCitem/fashionProd/csRange/garmentVariant/variantType/@codeList) [Optional]</p> <p>- nota: <i>this attribute should be ALTERNATIVE to the others</i></p> <p>(XPath FASCatalog/FCbody/FCgroup/FCitem/garmentCategory/artGroup/@codeList) [Optional]</p> <p>- nota: <i>this attribute should be ALTERNATIVE to the others</i></p> <p>(XPath FASCatalog/garComInfo/brand/@codeList) [Optional]</p> <p>(XPath FASCatalog/terms/allowanceCharge/dtScheme/legalRef/@codeList) [Required]</p> <p>(XPath FASCatalog/FCbody/FCgroup/FCitem/allowanceCharge/dtScheme/note/@codeList) [Optional]</p> |

- nota: *must be used to provide (URL) the list of codes used in "noteLabel"*  
(XPath FASCatalog/FCbody/FCgroup/FCitem/garComInfo/season/@codeList) [Optional]  
(XPath FASCatalog/FCbody/FCgroup/FCitem/fashionProd/csRange/color/@codeList) [Optional]

- nota: *this attribute could be used as alternative to the others*  
(XPath FASCatalog/garComInfo/operationalCode/@codeList) [Optional]  
(XPath FASCatalog/FCbody/FCgroup/FCitem/fashionProd/garmentPartCode/fabric/@codeList) [Optional]

- nota: *this attribute should be ALTERNATIVE to the others*  
(XPath FASCatalog/FCbody/FCgroup/FCitem/fashionProd/garmentCode/garmentCodeB/fabric/@codeList) [Optional]

- nota: *this attribute should be ALTERNATIVE to the others*  
(XPath FASCatalog/FCbody/FCgroup/FCitem/fashionProd/garmentPartCode/color/@codeList) [Optional]

- nota: *this attribute could be used as alternative to the others*  
(XPath FASCatalog/FCbody/FCgroup/FCitem/fashionProd/garmentPartCode/mod/@codeList) [Optional]

- nota: *this attribute should be ALTERNATIVE to the others*  
(XPath FASCatalog/FCheader/refDoc/season/@codeList) [Optional]  
(XPath FASCatalog/FCbody/FCgroup/FCitem/fashionProd/garmentCode/garmentCodeB/color/@codeList) [Optional]

- nota: *this attribute could be used as alternative to the others*  
(XPath FASCatalog/FCbody/FCgroup/refDoc/season/@codeList) [Optional]  
(XPath FASCatalog/FCbody/FCgroup/FCitem/note/@codeList) [Optional]

- nota: *must be used to provide (URL) the list of codes used in "noteLabel"*  
(XPath FASCatalog/FCbody/FCgroup/note/@codeList) [Optional]

- nota: *must be used to provide (URL) the list of codes used in "noteLabel"*  
(XPath FASCatalog/FCbody/FCgroup/FCitem/fashionProd/garmentPartCode/size/@codeList) [Optional]  
(XPath FASCatalog/FCbody/FCgroup/FCitem/dtScheme/note/@codeList) [Optional]

- nota: *must be used to provide (URL) the list of codes used in "noteLabel"*  
(XPath FASCatalog/FCbody/FCgroup/FCitem/garComInfo/note/@codeList) [Optional]

- nota: *must be used to provide (URL) the list of codes used in "noteLabel"*  
(XPath FASCatalog/FCbody/FCgroup/FCitem/fashionProd/garmentCode/garmentCodeB/mod/@codeList) [Optional]

- nota: *this attribute should be ALTERNATIVE to the others*  
(XPath FASCatalog/FCbody/FCgroup/FCitem/dtScheme/legalRef/@codeList) [Required]

(XPath FASCatalog/FCbody/FCgroup/FCitem/fashionProd/garmentCode/garmentCodeB/drop/@codeList) [Optional]  
(XPath FASCatalog/FCbody/FCgroup/FCitem/operationalCode/@codeList) [Optional]

(XPath FASCatalog/FCbody/FCgroup/FCitem/productLine/@codeList) [Optional]  
(XPath FASCatalog/garComInfo/note/@codeList) [Optional]

- nota: *must be used to provide (URL) the list of codes used in "noteLabel"*  
(XPath FASCatalog/FCbody/FCgroup/FCitem/garComInfo/productLine/@codeList) [Optional]  
(XPath FASCatalog/FCbody/FCgroup/FCitem/fashionProd/garmentCode/garmentCodeB/artGroup/@codeList) [Optional]

- nota: *this attribute should be ALTERNATIVE to the others*  
(XPath FASCatalog/FCbody/FCgroup/FCitem/fashionProd/garmentCode/garmentCodeB/size/@codeList) [Optional]  
(XPath FASCatalog/FCbody/FCgroup/FCitem/fashionProd/acsCode/color/@codeList) [Optional]

- nota: *this attribute could be used as alternative to the others*  
(XPath FASCatalog/FCbody/FCgroup/FCitem/picture/note/@codeList) [Optional]

- nota: *must be used to provide (URL) the list of codes used in "noteLabel"*  
(XPath FASCatalog/FCbody/FCgroup/FCitem/fashionProd/garmentCode/garmentCodeB/garmentVariant/variantType/@codeList) [Optional]

- nota: *this attribute should be ALTERNATIVE to the others*  
(XPath FASCatalog/FCbody/FCgroup/FCitem/fashionProd/garmentCode/garmentCodeB/garmentVariant/variantCode/@codeList) [Optional]



- nota: *this attribute should be ALTERNATIVE to the others*  
(XPath FASCatalog/FCbody/FCgroup/FCitem/brand/@codeList) [Optional]  
(XPath FASCatalog/FCbody/FCgroup/artGroup/@codeList) [Optional]

- nota: *this attribute should be ALTERNATIVE to the others*  
(XPath FASCatalog/FCbody/FCgroup/FCitem/garComInfo/operationalCode/@codeList) [Optional]  
(XPath FASCatalog/FCbody/FCgroup/FCitem/marketPrice/allowanceCharge/dtScheme/note/@codeList) [Optional]

- nota: *must be used to provide (URL) the list of codes used in "noteLabel"*  
(XPath FASCatalog/FCbody/FCgroup/garComInfo/brand/@codeList) [Optional]  
(XPath FASCatalog/FCbody/FCgroup/FCitem/measureConversion/unitOfTargetMeasure/@codeList) [Optional]  
(XPath FASCatalog/FCbody/FCgroup/FCitem/fashionProd/note/@codeList) [Optional]

- nota: *must be used to provide (URL) the list of codes used in "noteLabel"*  
(XPath FASCatalog/FCbody/FCgroup/FCitem/fashionProd/texCode/art/@codeList) [Optional]

- nota: *this attribute should be ALTERNATIVE to the others*  
(XPath FASCatalog/FCbody/FCgroup/FCitem/fashionProd/csRange/sizeMatrix/sizeRow/itemsList/qualityLevel/@codeList) [Optional]  
(XPath FASCatalog/FCbody/FCgroup/FCitem/packages/handlingChar/note/@codeList) [Optional]

- nota: *must be used to provide (URL) the list of codes used in "noteLabel"*  
(XPath FASCatalog/FCheader/season/@codeList) [Optional]  
(XPath FASCatalog/FCbody/FCgroup/FCitem/garmentCategory/goodsClassification/class/@codeList) [Optional]  
(XPath FASCatalog/FCbody/FCgroup/FCitem/refDoc/season/@codeList) [Optional]  
(XPath FASCatalog/FCbody/FCgroup/FCitem/unitOfMeasure/@codeList) [Optional]  
(XPath FASCatalog/FCbody/FCgroup/allowanceCharge/dtScheme/note/@codeList) [Optional]

- nota: *must be used to provide (URL) the list of codes used in "noteLabel"*  
(XPath FASCatalog/FCbody/FCgroup/FCitem/fashionProd/texCode/pattern/@codeList) [Optional]

- nota: *this attribute should be ALTERNATIVE to the others*  
(XPath FASCatalog/FCbody/FCgroup/allowanceCharge/dtScheme/legalRef/@codeList) [Required]  
(XPath FASCatalog/FCbody/FCgroup/FCitem/measureConversion/unitOfSourceMeasure/@codeList) [Optional]  
(XPath FASCatalog/FCbody/FCgroup/FCitem/garmentCategory/goodsClassification/macroClass/@codeList) [Optional]  
(XPath FASCatalog/FCbody/FCgroup/FCitem/fashionProd/additionalComponentCode/@codeList) [Optional]  
(XPath FASCatalog/FCbody/FCgroup/FCitem/fashionProd/texCode/color/@codeList) [Optional]

- nota: *this attribute could be used as alternative to the others*  
(XPath FASCatalog/FCbody/FCgroup/garComInfo/note/@codeList) [Optional]

- nota: *must be used to provide (URL) the list of codes used in "noteLabel"*  
(XPath FASCatalog/FCbody/FCgroup/FCitem/fashionProd/yarnCode/art/@codeList) [Optional]

- nota: *this attribute should be ALTERNATIVE to the others*  
(XPath FASCatalog/FCbody/FCgroup/FCitem/garmentCategory/artSex/@codeList) [Optional]

- nota: *this attribute should be ALTERNATIVE to the others*  
(XPath FASCatalog/FCbody/FCgroup/FCitem/garmentCategory/season/@codeList) [Optional]  
(XPath FASCatalog/FCheader/note/@codeList) [Optional]

- nota: *must be used to provide (URL) the list of codes used in "noteLabel"*  
(XPath FASCatalog/FCbody/FCgroup/garComInfo/operationalCode/@codeList) [Optional]  
(XPath FASCatalog/FCbody/FCgroup/FCitem/marketPrice/allowanceCharge/dtScheme/legalRef/@codeList) [Required]  
(XPath FASCatalog/FCbody/FCgroup/FCitem/fashionProd/csRange/sizeMatrix/sizeRow/additionalComponentCode/@codeList) [Optional]  
(XPath FASCatalog/FCbody/FCgroup/garComInfo/season/@codeList) [Optional]

|                |  |
|----------------|--|
|                | <p>(XPath FASCatalog/FCheader/picture/note/@codeList) [Optional]<br/> - nota: <i>must be used to provide (URL) the list of codes used in "noteLabel"</i><br/> (XPath FASCatalog/FCbody/FCgroup/FCitem/garmentCategory/goodsClassification/subClass/@codeList) [Optional]<br/> (XPath FASCatalog/FCbody/FCgroup/FCitem/fashionProd/csRange/sizeMatrix/sizeRow/size/@codeList) [Optional]<br/> (XPath FASCatalog/FCbody/FCgroup/FCitem/fashionProd/csRange/sizeMatrix/sizeRow/drop/@codeList) [Optional]<br/> (XPath FASCatalog/FCbody/FCgroup/garComInfo/productLine/@codeList) [Optional]<br/> ]</p> <p>(XPath FASCatalog/FCbody/FCgroup/FCitem/fashionProd/yarnCode/color/@codeList) [Optional]<br/> - nota: <i>this attribute could be used as alternative to the others</i><br/> (XPath FASCatalog/FCbody/FCgroup/FCitem/garmentCategory/note/@codeList) [Optional]<br/> - nota: <i>must be used to provide (URL) the list of codes used in "noteLabel"</i></p> |
| @codeQualifier | <p>operational code qualifier: it states if the code is related to a project, an event, an initiative, a sales channel, a management type (eg CITES), .....</p> <p>- base type: string, cod. table: NT43<br/> <a href="http://www.ebiz.enea.it/moda-ml/repository/codelist/draft/gc_NT43.xml">http://www.ebiz.enea.it/moda-ml/repository/codelist/draft/gc_NT43.xml</a><br/> (XPath FASCatalog/FCbody/FCgroup/FCitem/garComInfo/operationalCode/@codeQualifier) [Optional]<br/> (XPath FASCatalog/FCbody/FCgroup/garComInfo/operationalCode/@codeQualifier) [Optional]<br/> (XPath FASCatalog/FCbody/FCgroup/FCitem/operationalCode/@codeQualifier) [Optional]<br/> (XPath FASCatalog/garComInfo/operationalCode/@codeQualifier) [Optional]</p>  |
| color          | <p>colour number of the product, when not included in the model or fabric code<br/> - base type: string, max length: 15,<br/> (XPath FASCatalog/FCbody/FCgroup/FCitem/fashionProd/acsCode/color) 0-1<br/> (XPath FASCatalog/FCbody/FCgroup/FCitem/fashionProd/garmentCode/garmentCodeB/color) 0-1<br/> (XPath FASCatalog/FCbody/FCgroup/FCitem/fashionProd/garmentPartCode/color) 0-1<br/> - note: <i>when a garment component, it should be the code assigned to the garment article</i><br/> (XPath FASCatalog/FCbody/FCgroup/FCitem/fashionProd/csRange/color) 0-1<br/> - note: <i>used only if not already specified in the article code</i><br/> (XPath FASCatalog/FCbody/FCgroup/FCitem/fashionProd/yarnCode/color) 0-1<br/> (XPath FASCatalog/FCbody/FCgroup/FCitem/fashionProd/texCode/color) 0-1</p>  |
| conversionRate | <p>Conversion parameter between two sizes.<br/> - base type: decimal,<br/> (XPath FASCatalog/FCbody/FCgroup/FCitem/measureConversion/conversionRate) 1-1</p>   |
| country        | <p>code of the nation<br/> - base type: string, cod. table: T10<br/> <a href="http://www.ebiz.enea.it/moda-ml/repository/codelist/draft/gc_T10.xml">http://www.ebiz.enea.it/moda-ml/repository/codelist/draft/gc_T10.xml</a><br/> (XPath FASCatalog/FCheader/supplier/country) 0-1<br/> (XPath FASCatalog/FCheader/buyer/country) 0-1<br/> (XPath FASCatalog/FCheader/thirdParty/country) 0-1</p>  |
| @currency      | <p>currency in which a specified monetary data is expressed<br/> - base type: string, cod. table: T9<br/> <a href="http://www.ebiz.enea.it/moda-ml/repository/codelist/draft/gc_T9.xml">http://www.ebiz.enea.it/moda-ml/repository/codelist/draft/gc_T9.xml</a><br/> (XPath FASCatalog/terms/allowanceCharge/@currency) [Optional]<br/> (XPath FASCatalog/FCbody/FCgroup/allowanceCharge/@currency) [Optional]<br/> (XPath FASCatalog/FCbody/FCgroup/FCitem/marketPrice/allowanceCharge/@currency) [Optional]</p>  |

|                  |   |
|------------------|---|
|                  | <p>(XPath FASCatalog/FCbody/FCgroup/FCitem/allowanceCharge/@currency) [Optional]</p> <p>(XPath FASCatalog/FCbody/FCgroup/FCitem/marketPrice/catalogPrice/@currency) [Optional]</p> <p>- nota: <i>Currency referred by the price.</i></p>  |
| @dateForm        | <p>format used for the date</p> <p>- base type: string, cod. table: NT29</p> <p><a href="http://www.ebiz.enea.it/moda-ml/repository/codelist/draft/gc_NT29.xml">http://www.ebiz.enea.it/moda-ml/repository/codelist/draft/gc_NT29.xml</a></p> <p>(XPath FASCatalog/FCbody/FCgroup/FCitem/garComInfo/deliveryDate/@dateForm) [Optional]</p> <p>(XPath FASCatalog/FCheader/refDoc/docDate/@dateForm) [Optional]</p> <p>(XPath FASCatalog/FCbody/FCgroup/FCitem/garComInfo/specDate/@dateForm) [Optional]</p> <p>(XPath FASCatalog/FCbody/FCgroup/garComInfo/deliveryDate/@dateForm) [Optional]</p> <p>(XPath FASCatalog/FCheader/msgDate/@dateForm) [Optional]</p> <p>(XPath FASCatalog/FCbody/FCgroup/picture/validityStart/@dateForm) [Optional]</p> <p>(XPath FASCatalog/FCbody/FCgroup/picture/validityEnd/@dateForm) [Optional]</p> <p>(XPath FASCatalog/FCbody/FCgroup/refDoc/docDate/@dateForm) [Optional]</p> <p>(XPath FASCatalog/FCheader/validityStart/@dateForm) [Optional]</p> <p>(XPath FASCatalog/FCbody/FCgroup/FCitem/picture/validityStart/@dateForm) [Optional]</p> <p>(XPath FASCatalog/FCbody/FCgroup/FCitem/picture/validityEnd/@dateForm) [Optional]</p> <p>(XPath FASCatalog/FCheader/validityEnd/@dateForm) [Optional]</p> <p>(XPath FASCatalog/FCheader/picture/validityEnd/@dateForm) [Optional]</p> <p>(XPath FASCatalog/terms/transInfo/delEffectiveDate/@dateForm) [Optional]</p> <p>(XPath FASCatalog/terms/transInfo/despatchDate/@dateForm) [Optional]</p> <p>(XPath FASCatalog/FCheader/picture/validityStart/@dateForm) [Optional]</p> <p>(XPath FASCatalog/garComInfo/specDate/@dateForm) [Optional]</p> <p>(XPath FASCatalog/FCbody/FCgroup/FCitem/refDoc/docDate/@dateForm) [Optional]</p> <p>(XPath FASCatalog/FCbody/FCgroup/garComInfo/specDate/@dateForm) [Optional]</p> <p>(XPath FASCatalog/garComInfo/deliveryDate/@dateForm) [Optional]</p> |
| delEffectiveDate | <p>effective date of delivery of goods (declared in Despatch), according to one of the patterns YYYY-MM-DD, YYYY-MM-DD:HH-MM or YYYY-WW.</p> <p>- base type: string,</p> <p>(XPath FASCatalog/terms/transInfo/delEffectiveDate) 0-1</p>   |
| deliveryDate     | <p>date of delivery of goods, requested or promised in the purchase process, according to one of the patterns YYYY-MM-DD, YYYY-MM-DD:HH-MM or YYYY-WW.</p> <p>- base type: string,</p> <p>(XPath FASCatalog/FCbody/FCgroup/garComInfo/deliveryDate) 0-1</p> <p>(XPath FASCatalog/FCbody/FCgroup/FCitem/garComInfo/deliveryDate) 0-1</p> <p>(XPath FASCatalog/garComInfo/deliveryDate) 0-1</p>   |
| deliveryPlace    | <p>place of delivery of goods, ultimate or related to a given leg</p> <p>- base type: string, max length: 250,</p> <p>(XPath FASCatalog/terms/transInfo/deliveryPlace) 0-1</p>  |
| dept             | <p>name or code of a contact department within a Party</p> <p>- base type: string, max length: 40,</p> <p>(XPath FASCatalog/FCheader/supplier/dept) 0-1</p> <p>(XPath FASCatalog/FCheader/buyer/dept) 0-1</p> <p>(XPath FASCatalog/FCheader/thirdParty/dept) 0-1</p>  |
| description      | <p>free text description. The content of the element must be unique, it might be translated and repeated into more languages (thus no more than one instance for each language).</p> <p>- base type: string, max length: 250,</p> <p>(XPath FASCatalog/FCbody/FCgroup/FCitem/fashionProd/texCode/description) 0-unbounded</p> <p>- note: <i>Product description</i></p> <p>(XPath FASCatalog/FCbody/FCgroup/FCitem/picture/description) 0-unbounded</p>   |



|               |   |
|---------------|---|
|               | <p>- note: <i>Only one instance of this element for each different value of 'ln' attribute (language)</i><br/>(XPath FASCatalog/FCbody/FCgroup/FCitem/fashionProd/yarnCode/description) 0-unbounded</p> <p>- note: <i>Product description</i><br/>(XPath FASCatalog/FCbody/FCgroup/picture/description) 0-unbounded</p> <p>- note: <i>Only one instance of this element for each different value of 'ln' attribute (language)</i><br/>(XPath FASCatalog/FCbody/FCgroup/FCitem/fashionProd/acsCode/description) 0-unbounded</p> <p>- note: <i>Product description</i><br/>(XPath FASCatalog/FCbody/FCgroup/description) 0-unbounded</p> <p>- note: <i>group description</i><br/>(XPath FASCatalog/FCheader/picture/description) 0-unbounded</p> <p>- note: <i>Only one instance of this element for each different value of 'ln' attribute (language)</i><br/>(XPath FASCatalog/FCbody/FCgroup/FCitem/composition/description) 0-unbounded</p> <p>- note: <i>Free text description of the composition of the product or its part</i><br/>(XPath FASCatalog/FCbody/FCgroup/FCitem/fashionProd/garmentCode/garmentCodeB/description) 0-unbounded</p> <p>- note: <i>Product description</i><br/>(XPath FASCatalog/FCbody/FCgroup/FCitem/fashionProd/garmentCode/garmentCodeA/description) 0-unbounded</p> <p>- note: <i>Product description</i><br/>(XPath FASCatalog/FCbody/FCgroup/FCitem/fashionProd/garmentPartCode/description) 0-unbounded</p> <p>- note: <i>Product part description</i><br/>(XPath FASCatalog/FCbody/FCgroup/FCitem/packages/description) 0-unbounded</p> |
| despatchDate  | <p>date of despatch of goods, requested or promised in the purchase process, according to one of the patterns YYYY-MM-DD, YYYY-MM-DD:HH-MM or YYY-WW.</p> <p>- base type: string,<br/>(XPath FASCatalog/terms/transInfo/despatchDate) 0-1</p>   |
| despatchPlace | <p>place of despatch of goods, origin or related to a given leg</p> <p>- base type: string, max length: 250,<br/>(XPath FASCatalog/terms/transInfo/despatchPlace) 0-1</p>   |
| docDate       | <p>date of issue of the referenced document, according to one of the patterns YYY-MM-DD, YYYY-MM-DD:HH-MM or YYYY-WW.</p> <p>- base type: string,<br/>(XPath FASCatalog/FCbody/FCgroup/refDoc/docDate) 0-1<br/>(XPath FASCatalog/FCheader/refDoc/docDate) 0-1<br/>(XPath FASCatalog/FCbody/FCgroup/FCitem/refDoc/docDate) 0-1</p>   |
| docID         | <p>identification number of the referenced document SINCE 2008-1 ITS USE I N THE HEADER IS DISCOURAGED (REPLACED BY msgID)</p> <p>- base type: string, max length: 80,<br/>(XPath FASCatalog/FCbody/FCgroup/FCitem/refDoc/docID) 1-2<br/>(XPath FASCatalog/FCbody/FCgroup/refDoc/docID) 1-2<br/>(XPath FASCatalog/FCheader/refDoc/docID) 1-2</p>  |
| @docType      | <p>type or class to which the referenced document belongs</p> <p>- base type: string, cod. table: T21<br/><a href="http://www.ebiz.enea.it/moda-ml/repository/codelist/draft/gc_T21.xml">http://www.ebiz.enea.it/moda-ml/repository/codelist/draft/gc_T21.xml</a><br/>(XPath FASCatalog/FCbody/FCgroup/FCitem/refDoc/@docType) [Required]<br/>(XPath FASCatalog/FCbody/FCgroup/refDoc/@docType) [Required]<br/>(XPath FASCatalog/FCheader/refDoc/@docType) [Required]</p>   |
| drop          | <p>drop number of the garment</p> <p>- base type: string, max length: 15,<br/>(XPath FASCatalog/FCbody/FCgroup/FCitem/fashionProd/csRange/drop) 0-1</p> <p>- note: <i>used only if not already specified in the article code</i></p>  |

|                     |   |
|---------------------|---|
|                     | <p>(XPath FASCatalog/FCbody/FCgroup/FCitem/fashionProd/csRange/sizeMatrix/sizeRow/drop) 0-1</p> <p>- note: <i>DEPRECATED</i>, anyhow it is used only if not already specified in the article code or csRange</p> <p>(XPath FASCatalog/FCbody/FCgroup/FCitem/fashionProd/garmentCode/garmentCodeB/drop) 0-1</p> <p>- note: <i>Fill this element if the drop is the same for all the sizes of the model. Otherway specify it within the csRange element</i></p>   |
| @email              | <p>electronic mail address of the contact person within a Party</p> <p>- base type: string, max length: 250,</p> <p>(XPath FASCatalog/FCheader/buyer/person/@email) [Optional]</p> <p>(XPath FASCatalog/FCheader/supplier/person/@email) [Optional]</p> <p>(XPath FASCatalog/FCheader/thirdParty/person/@email) [Optional]</p>  |
| @encoding           | <p>specifies the decoding algorithm of the binary object</p> <p>- base type: normalizedString,</p> <p>(XPath FASCatalog/FCbody/FCgroup/FCitem/picture/attachment/binaryObject/@encoding) [Optional]</p> <p>(XPath FASCatalog/FCbody/FCgroup/picture/attachment/binaryObject/@encoding) [Optional]</p> <p>(XPath FASCatalog/FCbody/FCgroup/refDoc/attachment/binaryObject/@encoding) [Optional]</p> <p>(XPath FASCatalog/FCbody/FCgroup/FCitem/refDoc/attachment/binaryObject/@encoding) [Optional]</p> <p>(XPath FASCatalog/FCheader/picture/attachment/binaryObject/@encoding) [Optional]</p> <p>(XPath FASCatalog/FCheader/refDoc/attachment/binaryObject/@encoding) [Optional]</p>   |
| encodingCode        | <p>the encoding/decoding algorithm used with the external object</p> <p>- base type: normalizedString,</p> <p>(XPath FASCatalog/FCheader/refDoc/attachment/externalReference/encodingCode) 0-1</p> <p>(XPath FASCatalog/FCbody/FCgroup/picture/attachment/externalReference/encodingCode) 0-1</p> <p>(XPath FASCatalog/FCbody/FCgroup/FCitem/picture/attachment/externalReference/encodingCode) 0-1</p> <p>(XPath FASCatalog/FCbody/FCgroup/refDoc/attachment/externalReference/encodingCode) 0-1</p> <p>(XPath FASCatalog/FCbody/FCgroup/FCitem/refDoc/attachment/externalReference/encodingCode) 0-1</p> <p>(XPath FASCatalog/FCheader/picture/attachment/externalReference/encodingCode) 0-1</p>   |
| @endUse             | <p>specifies the final use of the fabric</p> <p>- base type: string, cod. table: NT4</p> <p><a href="http://www.ebiz.enea.it/moda-ml/repository/codelist/draft/gc_NT4.xml">http://www.ebiz.enea.it/moda-ml/repository/codelist/draft/gc_NT4.xml</a></p> <p>(XPath FASCatalog/FCbody/FCgroup/FCitem/garComInfo/@endUse) [Optional]</p> <p>- nota: <i>When used for garments, use only PR: Production or SA: Sample codes.</i></p> <p>(XPath FASCatalog/garComInfo/@endUse) [Optional]</p> <p>- nota: <i>When used for garments, use only PR: Production or SA: Sample codes.</i></p> <p>(XPath FASCatalog/FCbody/FCgroup/garComInfo/@endUse) [Optional]</p> <p>- nota: <i>When used for garments, use only PR: Production or SA: Sample codes.</i></p> |
| EPC                 | <p>serial identifier used for tracing a physical item with RFID technology</p> <p>- base type: string,</p> <p>(XPath FASCatalog/FCbody/FCgroup/FCitem/packages/EPClist/EPC) 1-unbounded</p>   |
| extendedDescription | <p>extended free text description. The content of the element must be unique, it might be translated and repeated into more languages (thus no more than o</p>  |

|                  |  |
|------------------|--|
|                  | <p>ne instance for each language). This element might contain HTML code (must be managed as CDATA)</p> <p>- base type: string,<br/>(XPath FASCatalog/FCbody/FCgroup/extendedDescription) 0-unbounded</p> <p>- note: <i>group extended description</i><br/>(XPath FASCatalog/FCbody/FCgroup/FCitem/extendedDescription) 0-unbounded</p> <p>- note: <i>Extended product description</i></p>  |
| fabric           | <p>fabric number of the garment</p> <p>- base type: string, max length: 15,<br/>(XPath FASCatalog/FCbody/FCgroup/FCitem/fashionProd/garmentPartCode/fabric) 0-1</p> <p>- note: <i>when a garment component, it should be the code assigned to the garment article</i><br/>(XPath FASCatalog/FCbody/FCgroup/FCitem/fashionProd/garmentCode/garmentCodeB/fabric) 0-1</p>   |
| @fax             | <p>fax number of the contact person within a Party</p> <p>- base type: string, max length: 35,<br/>(XPath FASCatalog/FCheader/thirdParty/person/@fax) [Optional]<br/>(XPath FASCatalog/FCheader/buyer/person/@fax) [Optional]<br/>(XPath FASCatalog/FCheader/supplier/person/@fax) [Optional]</p>  |
| @fibre           | <p>type of fibre used in a textile product</p> <p>- base type: string, cod. table: T19<br/><a href="http://www.ebiz.enea.it/moda-ml/repository/codelist/draft/gc_T19.xml">http://www.ebiz.enea.it/moda-ml/repository/codelist/draft/gc_T19.xml</a><br/>(XPath FASCatalog/FCbody/FCgroup/FCitem/composition/garmentCompos/percCompos/@fibre) [Required]</p>   |
| fileName         | <p>unique identifier (name) of the file</p> <p>- base type: string, max length: 255,<br/>(XPath FASCatalog/FCbody/FCgroup/FCitem/refDoc/attachment/fileName) 0-1<br/>(XPath FASCatalog/FCbody/FCgroup/picture/attachment/fileName) 0-1<br/>(XPath FASCatalog/FCheader/picture/attachment/fileName) 0-1<br/>(XPath FASCatalog/FCbody/FCgroup/FCitem/picture/attachment/fileName) 0-1<br/>(XPath FASCatalog/FCheader/refDoc/attachment/fileName) 0-1<br/>(XPath FASCatalog/FCbody/FCgroup/refDoc/attachment/fileName) 0-1</p>  |
| fillingCriterion | <p>the assortment criterion to fill the specified kind of package: it states the homogeneity criterion (eg: "model", "color", "size").</p> <p>- base type: string, cod. table: NT51<br/><a href="http://www.ebiz.enea.it/moda-ml/repository/codelist/draft/gc_NT51.xml">http://www.ebiz.enea.it/moda-ml/repository/codelist/draft/gc_NT51.xml</a><br/>(XPath FASCatalog/FCbody/FCgroup/FCitem/packages/fillingCriterion) 0-9</p>   |
| @finDiscount     | <p>financial discount rate applied for payment by the date specified</p> <p>- base type: decimal, min inclusive: 0, max inclusive: 100, fraction digits: 2,<br/>(XPath FASCatalog/terms/payment/@finDiscount) [Optional]</p>   |
| @finSurcharge    | <p>financial surcharge rate applied for payment after the date specified</p> <p>- base type: decimal, min inclusive: 0, max inclusive: 100, fraction digits: 2,<br/>(XPath FASCatalog/terms/payment/@finSurcharge) [Optional]</p>  |
| @format          | <p>the format of the binary content</p> <p>- base type: string,<br/>(XPath FASCatalog/FCheader/picture/attachment/binaryObject/@format) [Optional]<br/>(XPath FASCatalog/FCbody/FCgroup/picture/attachment/binaryObject/@format) [Optional]<br/>(XPath FASCatalog/FCbody/FCgroup/FCitem/refDoc/attachment/binaryObject/@format) [Optional]<br/>(XPath FASCatalog/FCbody/FCgroup/refDoc/attachment/binaryObject/@format) [Optional]<br/>(XPath FASCatalog/FCheader/refDoc/attachment/binaryObject/@format) [Optional]<br/>(XPath FASCatalog/FCbody/FCgroup/FCitem/picture/attachment/binaryObject/@format) [Optional]</p> |

|                    |  |
|--------------------|--|
| formatCode         | <p>the format of the external object</p> <ul style="list-style-type: none"> <li>- base type: normalizedString,</li> </ul> <p>(XPath FASCatalog/FCbody/FCgroup/FCitem/refDoc/attachment/externalReference/formatCode) 0-1</p> <p>(XPath FASCatalog/FCbody/FCgroup/picture/attachment/externalReference/formatCode) 0-1</p> <p>(XPath FASCatalog/FCbody/FCgroup/refDoc/attachment/externalReference/formatCode) 0-1</p> <p>(XPath FASCatalog/FCheader/picture/attachment/externalReference/formatCode) 0-1</p> <p>(XPath FASCatalog/FCbody/FCgroup/FCitem/picture/attachment/externalReference/formatCode) 0-1</p> <p>(XPath FASCatalog/FCheader/refDoc/attachment/externalReference/formatCode) 0-1</p> |
| @garmentMarket     | <p>market segment for the product</p> <ul style="list-style-type: none"> <li>- base type: string, length: 255,</li> </ul> <p>(XPath FASCatalog/FCbody/FCgroup/FCitem/marketPrice/catalogPrice/@garmentMarket) [Optional]</p>   |
| garPackCode        | <p>a code specifying the type of packaging used for the item.</p> <ul style="list-style-type: none"> <li>- base type: string,</li> </ul> <p>(XPath FASCatalog/FCbody/FCgroup/FCitem/packages/handlingChar/garPack/garPackCode) 1-1</p>   |
| garPackText        | <p>a free text specifying the type of packaging used for the item.</p> <ul style="list-style-type: none"> <li>- base type: string,</li> </ul> <p>(XPath FASCatalog/FCbody/FCgroup/FCitem/packages/handlingChar/garPack/garPackText) 1-1</p>  |
| geographicAreaCode | <p>code identifying a geographic area</p> <ul style="list-style-type: none"> <li>- base type: string, cod. table: T10</li> </ul> <p><a href="http://www.ebiz.enea.it/moda-ml/repository/codelist/draft/gc_T10.xml">http://www.ebiz.enea.it/moda-ml/repository/codelist/draft/gc_T10.xml</a></p> <p>(XPath FASCatalog/FCbody/FCgroup/FCitem/marketPrice/geographicArea/geographicAreaCode) 1-1</p>  |
| geographicAreaText | <p>text identifying a geographic area</p> <ul style="list-style-type: none"> <li>- base type: string,</li> </ul> <p>(XPath FASCatalog/FCbody/FCgroup/FCitem/marketPrice/geographicArea/geographicAreaText) 1-1</p> <hr/> <p>AAAA-WARNING! - text not AVAILABLE n. 245 - In=en</p>  |
| gPart              | <p>code specifying the type of component or part of a fashion product (sleeve, neck, ...)</p> <ul style="list-style-type: none"> <li>- base type: string, cod. table: T48</li> </ul> <p><a href="http://www.ebiz.enea.it/moda-ml/repository/codelist/draft/gc_T48.xml">http://www.ebiz.enea.it/moda-ml/repository/codelist/draft/gc_T48.xml</a></p> <p>(XPath FASCatalog/FCbody/FCgroup/FCitem/fashionProd/garmentPartCode/gPart) 1-1</p>  |
| grossWeight        | <p>the gross weight, declared for transport or customs purpose</p> <ul style="list-style-type: none"> <li>- base type: decimal, min inclusive: 0, fraction digits: 2,</li> </ul> <p>(XPath FASCatalog/FCbody/FCgroup/FCitem/packages/handlingChar/grossWeight) 0-1</p> <p>(XPath FASCatalog/terms/transInfo/grossWeight) 0-1</p>   |
| handlingType       | <p>information to handle the item (eg "breakable").</p> <ul style="list-style-type: none"> <li>- base type: string,</li> </ul> <p>(XPath FASCatalog/FCbody/FCgroup/FCitem/packages/handlingChar/handlingType) 0-1</p>  |
| height             | <p>effective height of a specified object</p> <ul style="list-style-type: none"> <li>- base type: decimal, min inclusive: 0, fraction digits: 2,</li> </ul> <p>(XPath FASCatalog/FCbody/FCgroup/FCitem/productDim/height) 0-1</p> <p>(XPath FASCatalog/FCbody/FCgroup/FCitem/packages/packageDim/height) 0-1</p>   |

|              |   |
|--------------|---|
|              | <p>(XPath FASCatalog/FCbody/FCgroup/FCitem/picture/height) 0-1<br/> - note: the 'um' attribute of this element must be 'E37' (pixel)</p> <p>(XPath FASCatalog/FCheader/picture/height) 0-1<br/> - note: the 'um' attribute of this element must be 'E37' (pixel)</p> <p>(XPath FASCatalog/FCbody/FCgroup/picture/height) 0-1<br/> - note: the 'um' attribute of this element must be 'E37' (pixel)</p>  |
| id           | <p>primary identification code of a Party; it is recommended the format: nation code (ISO 3166) + VAT identification number (11 crt), with the qualifier "numberingOrg"= MF</p> <p>- base type: string, max length: 15,</p> <p>(XPath FASCatalog/FCheader/supplier/id) 1-1<br/> (XPath FASCatalog/FCheader/buyer/id) 1-1<br/> (XPath FASCatalog/FCheader/thirdParty/id) 1-1</p>   |
| @idQualifier | <p>Qualification of the identifier.</p> <p>- base type: string,</p> <p>(XPath FASCatalog/FCbody/FCgroup/FCitem/fashionProdc<br/> sRange/sizeMatrix/sizeRow/itemsList/itemIdentification/serialN/@idQualifier ) [Optional]</p> <p>- nota: this attribute should be used when the numberingOrg attribute is not enough to declare the type of serial identifier</p> <p>(XPath FASCatalog/FCheader/buyer/additionalIdentifier/@idQualifier) [Optional]</p> <p>- nota: this attribute should be used when the numberingOrg attribute is not enough to declare the type of identifier</p> <p>(XPath FASCatalog/FCheader/supplier/additionalIdentifier/@idQualifier) [Optional]</p> <p>- nota: this attribute should be used when the numberingOrg attribute is not enough to declare the type of identifier</p>  |
| incoTerm     | <p>specification of the terms of trade (INCOTERMS)</p> <p>- base type: string, cod. table: T3</p> <p><a href="http://www.ebiz.enea.it/moda-ml/repository/codelist/draft/gc_T3.xml">http://www.ebiz.enea.it/moda-ml/repository/codelist/draft/gc_T3.xml</a></p> <p>(XPath FASCatalog/terms/trade/incoTerm) 1-1</p>   |
| incoTermText | <p>free text specifying the terms of trade (incoterm, location)</p> <p>- base type: string, max length: 250,</p> <p>(XPath FASCatalog/terms/trade/incoTermText) 1-1</p>   |
| @isURL       | <p>it indicates if the referred element is an URL (true) or not (false)</p> <p>- base type: boolean,</p> <p>(XPath FASCatalog/FCheader/picture/attachment/externalReference/uri/@isURL) [Optional] [Default= true]</p> <p>- nota: usage of URLs is recommended</p> <p>(XPath FASCatalog/FCbody/FCgroup/FCitem/picture/attachment/externalReference/uri/@isURL) [Optional] [Default= true]</p> <p>- nota: usage of URLs is recommended</p> <p>(XPath FASCatalog/FCbody/FCgroup/refDoc/attachment/externalReference/uri/@isURL) [Optional] [Default= true]</p> <p>- nota: usage of URLs is recommended</p> <p>(XPath FASCatalog/FCbody/FCgroup/FCitem/refDoc/attachment/externalReference/uri/@isURL) [Optional] [Default= true]</p> <p>- nota: usage of URLs is recommended</p> <p>(XPath FASCatalog/FCheader/refDoc/attachment/externalReference/uri/@isURL) [Optional] [Default= true]</p> <p>- nota: usage of URLs is recommended</p> <p>(XPath FASCatalog/FCbody/FCgroup/picture/attachment/externalReference/uri/@isURL) [Optional] [Default= true]</p> <p>- nota: usage of URLs is recommended</p> |
| itemID       | <p>number of the line/item of the referenced document</p> <p>- base type: string, max length: 6,</p> <p>(XPath FASCatalog/FCheader/refDoc/itemID) 0-1<br/> (XPath FASCatalog/FCbody/FCgroup/FCitem/refDoc/itemID) 0-1<br/> (XPath FASCatalog/FCbody/FCgroup/refDoc/itemID) 0-1</p>  |

|                 |  |
|-----------------|--|
| itemsPerPackage | <p>the quantity of items that can be contained in a package.</p> <p>- base type: decimal,<br/>(XPath FASCatalog/FCbody/FCgroup/FCitem/packages/itemsPerPackage) 0-1</p>  |
| label           | <p>indicates if the physical object specified has to be labelled</p> <p>- base type: boolean,<br/>(XPath FASCatalog/FCbody/FCgroup/FCitem/packages/handlingChar/yarnPack/yarnReel/label) 0-1<br/>(XPath FASCatalog/FCbody/FCgroup/FCitem/packages/handlingChar/yarnPack/yarnInWrap/label) 0-1</p>  |
| labelWrit       | <p>text that must be written on the lable of a specified physical object when its customization is required</p> <p>- base type: string, max length: 350,<br/>(XPath FASCatalog/FCbody/FCgroup/FCitem/packages/handlingChar/yarnPack/yarnInWrap/labelWrit) 0-1<br/>(XPath FASCatalog/FCbody/FCgroup/FCitem/packages/handlingChar/yarnPack/yarnReel/labelWrit) 0-1</p>   |
| legalName       | <p>legal name of a Party</p> <p>- base type: string, max length: 250,<br/>(XPath FASCatalog/FCheader/thirdParty/legalName) 0-1<br/>(XPath FASCatalog/FCheader/buyer/legalName) 0-1<br/>(XPath FASCatalog/FCheader/supplier/legalName) 0-1</p>  |
| legalRef        | <p>legal reference of the duty or tax or fee category</p> <p>- base type: string,<br/>(XPath FASCatalog/FCbody/FCgroup/FCitem/marketPrice/allowanceCharge/dtScheme/legalRef) 0-1<br/>(XPath FASCatalog/FCbody/FCgroup/FCitem/allowanceCharge/dtScheme/legalRef) 0-1<br/>(XPath FASCatalog/terms/allowanceCharge/dtScheme/legalRef) 0-1<br/>(XPath FASCatalog/FCbody/FCgroup/allowanceCharge/dtScheme/legalRef) 0-1<br/>(XPath FASCatalog/FCbody/FCgroup/FCitem/dtScheme/legalRef) 0-1</p>  |
| length          | <p>effective length of a specified object</p> <p>- base type: decimal, min inclusive: 0, fraction digits: 2,<br/>(XPath FASCatalog/FCbody/FCgroup/FCitem/packages/packageDim/length) 1-1</p> <p>- note: <i>here the maximum dimension must also be specified</i><br/>(XPath FASCatalog/FCbody/FCgroup/FCitem/productDim/length) 1-1</p>  |
| lineID          | <p>unique identifier of the line item of the business document; it is set by the role that produces the document.</p> <p>- base type: string, max length: 30,<br/>(XPath FASCatalog/FCbody/FCgroup/FCitem/lineID) 0-1</p>  |
| lineN           | <p>number of the line item of the present message (xml document); it is set by the role that produces the document. Usually it is a progressive number, but not always.</p> <p>- base type: positiveInteger, min inclusive: 1, max inclusive: 9999,<br/>(XPath FASCatalog/FCbody/FCgroup/FCitem/lineN) 0-1</p>   |
| @listName       | <p>the name of the list of codes used to make an instance of the element (it might be thought as descriptive element, i.e. 'fabric printing technologies', or not, i.e. "T264")</p> <p>- base type: string, max length: 40,<br/>(XPath FASCatalog/FCbody/FCgroup/FCitem/garmentCategory/goodsClassification/subClass/@listName) [Optional]<br/>(XPath FASCatalog/FCbody/FCgroup/FCitem/operationalCode/@listName) [Optional]</p> <p>(XPath FASCatalog/FCbody/FCgroup/FCitem/fashionProd/garmentPartCode/color/@listName) [Optional]</p> <p>- nota: <i>this attribute should always be used coupled with "numberingOrg"</i><br/>(XPath FASCatalog/FCbody/FCgroup/FCitem/fashionProd/texCode/color/@listName) [Optional]</p> |



- nota: *this attribute should always be used coupled with “numberingOrg”*  
(XPath FASCatalog/FCbody/FCgroup/FCitem/fashionProd/  
garmentPartCode/fabric/@listName) [Optional]

- nota: *this attribute should always be used coupled with “numberingOrg”*  
(XPath FASCatalog/FCbody/FCgroup/FCitem/garComInfo/brand/@listName) [Optional]

(XPath FASCatalog/FCbody/FCgroup/FCitem/unitOfMeasure/@listName) [Optional]

(XPath FASCatalog/FCbody/FCgroup/FCitem/fashionProd/  
csRange/sizeMatrix/sizeRow/additionalComponentCode/@listName) [Optional]

(XPath FASCatalog/FCbody/FCgroup/FCitem/fashionProd/  
csRange/garmentVariant/variantCode/@listName) [Optional]

- nota: *this attribute should always be used coupled with “numberingOrg”*  
(XPath FASCatalog/FCbody/FCgroup/FCitem/fashionProd/  
texCode/pattern/@listName) [Optional]

- nota: *this attribute should always be used coupled with “numberingOrg”*  
(XPath FASCatalog/FCbody/FCgroup/FCitem/garComInfo/  
operationalCode/@listName) [Optional]

(XPath FASCatalog/FCbody/FCgroup/FCitem/fashionProd/  
garmentCode/garmentCodeB/mod/@listName) [Optional]

- nota: *this attribute should always be used coupled with “numberingOrg”*  
(XPath FASCatalog/FCbody/FCgroup/FCitem/garComInfo/  
productLine/@listName) [Optional]

(XPath FASCatalog/FCbody/FCgroup/FCitem/productLine/@listName) [Optional]

(XPath FASCatalog/FCbody/FCgroup/FCitem/fashionProd/  
texCode/art/@listName) [Optional]

- nota: *this attribute should always be used coupled with “numberingOrg”*  
(XPath FASCatalog/FCbody/FCgroup/FCitem/brand/@listName) [Optional]

(XPath FASCatalog/FCbody/FCgroup/FCitem/garComInfo/season/@listName) [Optional]

(XPath FASCatalog/FCbody/FCgroup/FCitem/fashionProd/  
garmentCode/garmentCodeB/color/@listName) [Optional]

- nota: *this attribute should always be used coupled with “numberingOrg”*  
(XPath FASCatalog/FCbody/FCgroup/FCitem/garmentCategory/  
goodsClassification/class/@listName) [Optional]

(XPath FASCatalog/FCbody/FCgroup/FCitem/garmentCategory/  
season/@listName) [Optional]

(XPath FASCatalog/FCbody/FCgroup/FCitem/fashionProd/  
yarnCode/color/@listName) [Optional]

- nota: *this attribute should always be used coupled with “numberingOrg”*  
(XPath FASCatalog/FCbody/FCgroup/FCitem/garmentCategory/  
artSex/@listName) [Optional]

- nota: *this attribute should always be used coupled with “numberingOrg”*  
(XPath FASCatalog/FCbody/FCgroup/FCitem/fashionProd/  
yarnCode/art/@listName) [Optional]

- nota: *this attribute should always be used coupled with “numberingOrg”*  
(XPath FASCatalog/FCbody/FCgroup/FCitem/fashionProd/  
acsCode/pattern/@listName) [Optional]

- nota: *this attribute should always be used coupled with “numberingOrg”*  
(XPath FASCatalog/FCbody/FCgroup/FCitem/fashionProd/  
garmentCode/garmentCodeB/garmentVariant/variantCode/@listName) [Optional]

- nota: *this attribute should always be used coupled with “numberingOrg”*  
(XPath FASCatalog/FCbody/FCgroup/FCitem/fashionProd/  
acsCode/art/@listName) [Optional]

- nota: *this attribute should always be used coupled with “numberingOrg”*  
(XPath FASCatalog/FCbody/FCgroup/FCitem/fashionProd/  
acsCode/color/@listName) [Optional]

- nota: *this attribute should always be used coupled with “numberingOrg”*  
(XPath FASCatalog/FCbody/FCgroup/FCitem/fashionProd/  
garmentCode/garmentCodeB/garmentVariant/variantType/@listName) [Optional]

- nota: *this attribute should always be used coupled with “numberingOrg”*  
(XPath FASCatalog/FCbody/FCgroup/FCitem/garmentCategory/  
goodsClassification/macroClass/@listName) [Optional]

|                            |  |
|----------------------------|--|
|                            | <p>(XPath FASCatalog/FCbody/FCgroup/FCitem/fashionProd/csRange/garmentVariant/variantType/@listName) [Optional]</p> <p>- nota: <i>this attribute should always be used coupled with “numberingOrg”</i></p> <p>(XPath FASCatalog/FCbody/FCgroup/FCitem/measureConversion/unitOfTargetMeasure/@listName) [Optional]</p> <p>(XPath FASCatalog/FCbody/FCgroup/FCitem/fashionProd/csRange/sizeMatrix/sizeRow/itemsList/qualityLevel/@listName) [Optional]</p> <p>(XPath FASCatalog/FCbody/FCgroup/FCitem/fashionProd/garmentPartCode/mod/@listName) [Optional]</p> <p>- nota: <i>this attribute should always be used coupled with “numberingOrg”</i></p> <p>(XPath FASCatalog/FCbody/FCgroup/FCitem/garmentCategory/artGroup/@listName) [Optional]</p> <p>- nota: <i>this attribute should always be used coupled with “numberingOrg”</i></p> <p>(XPath FASCatalog/FCbody/FCgroup/FCitem/measureConversion/unitOfSourceMeasure/@listName) [Optional]</p> <p>(XPath FASCatalog/FCbody/FCgroup/FCitem/fashionProd/garmentCode/garmentCodeA/art/@listName) [Optional]</p> <p>- nota: <i>this attribute should always be used coupled with “numberingOrg”</i></p> <p>(XPath FASCatalog/FCbody/FCgroup/FCitem/fashionProd/garmentCode/garmentCodeB/fabric/@listName) [Optional]</p> <p>- nota: <i>this attribute should always be used coupled with “numberingOrg”</i></p> <p>(XPath FASCatalog/FCbody/FCgroup/FCitem/fashionProd/additionalComponentCode/@listName) [Optional]</p> <p>(XPath FASCatalog/FCbody/FCgroup/FCitem/fashionProd/csRange/color/@listName) [Optional]</p> <p>- nota: <i>this attribute should always be used coupled with “numberingOrg”</i></p> <p>(XPath FASCatalog/FCbody/FCgroup/FCitem/garmentCategory/artSubGroup/@listName) [Optional]</p> <p>- nota: <i>this attribute should always be used coupled with “numberingOrg”</i></p> <p>(XPath FASCatalog/FCbody/FCgroup/FCitem/fashionProd/garmentCode/garmentCodeB/artGroup/@listName) [Optional]</p> <p>- nota: <i>this attribute should always be used coupled with “numberingOrg”</i></p> <p>(XPath FASCatalog/garComInfo/season/@listName) [Optional]</p> <p>(XPath FASCatalog/FCbody/FCgroup/refDoc/season/@listName) [Optional]</p> <p>(XPath FASCatalog/FCbody/FCgroup/artGroup/@listName) [Optional]</p> <p>- nota: <i>this attribute should always be used coupled with “numberingOrg”</i></p> <p>(XPath FASCatalog/FCheader/season/@listName) [Optional]</p> <p>(XPath FASCatalog/FCbody/FCgroup/garComInfo/productLine/@listName) [Optional]</p> <p>(XPath FASCatalog/garComInfo/operationalCode/@listName) [Optional]</p> <p>(XPath FASCatalog/FCbody/FCgroup/garComInfo/brand/@listName) [Optional]</p> <p>(XPath FASCatalog/FCbody/FCgroup/garComInfo/operationalCode/@listName) [Optional]</p> <p>(XPath FASCatalog/FCbody/FCgroup/garComInfo/season/@listName) [Optional]</p> <p>(XPath FASCatalog/FCheader/refDoc/season/@listName) [Optional]</p> <p>(XPath FASCatalog/FCbody/FCgroup/FCitem/refDoc/season/@listName) [Optional]</p> <p>(XPath FASCatalog/garComInfo/brand/@listName) [Optional]</p> <p>(XPath FASCatalog/garComInfo/productLine/@listName) [Optional]</p> |
| <p><i>@listVersion</i></p> | <p>it specifies the version of the list of codes used to make an instance of the element</p> <p>- base type: string, max length: 6,</p> <p>(XPath FASCatalog/FCbody/FCgroup/garComInfo/brand/@listVersion) [Optional]</p> <p>(XPath FASCatalog/FCheader/season/@listVersion) [Optional]</p> <p>(XPath FASCatalog/FCbody/FCgroup/garComInfo/season/@listVersion) [Optional]</p> <p>(XPath FASCatalog/FCbody/FCgroup/FCitem/fashionProd/yarnCode/color/@listVersion) [Optional]</p> <p>- nota: <i>this attribute should always be used coupled with “numberingOrg” and “listName”</i></p> <p>(XPath FASCatalog/garComInfo/brand/@listVersion) [Optional]</p> <p>(XPath FASCatalog/FCbody/FCgroup/FCitem/garmentCategory/goodsClassification/subClass/@listVersion) [Optional]</p> <p>(XPath FASCatalog/FCbody/FCgroup/FCitem/fashionProd/garmentCode/garmentCodeB/garmentVariant/variantCode/@listVersion) [Optional]</p>  |



- nota: *this attribute should always be used coupled with “numberingOrg” and “listName”*  
 (XPath FASCatalog/FCbody/FCgroup/FCitem/garmentCategory/goodsClassification/class/@listVersion) [Optional]  
 (XPath FASCatalog/FCbody/FCgroup/FCitem/garmentCategory/season/@listVersion) [Optional]  
 (XPath FASCatalog/FCbody/FCgroup/FCitem/garmentCategory/goodsClassification/macroClass/@listVersion) [Optional]  
 (XPath FASCatalog/FCbody/FCgroup/garComInfo/productLine/@listVersion) [Optional]  
 (XPath FASCatalog/FCbody/FCgroup/FCitem/fashionProd/yarnCode/art/@listVersion) [Optional]

- nota: *this attribute should always be used coupled with “numberingOrg” and “listName”*  
 (XPath FASCatalog/FCbody/FCgroup/artGroup/@listVersion) [Optional]

- nota: *this attribute should always be used coupled with “numberingOrg” and “listName”*  
 (XPath FASCatalog/FCbody/FCgroup/garComInfo/operationalCode/@listVersion) [Optional]  
 (XPath FASCatalog/FCbody/FCgroup/FCitem/fashionProd/additionalComponentCode/@listVersion) [Optional]  
 (XPath FASCatalog/FCbody/FCgroup/FCitem/fashionProd/csRange/sizeMatrix/sizeRow/itemsList/qualityLevel/@listVersion) [Optional]  
 (XPath FASCatalog/FCbody/FCgroup/FCitem/fashionProd/garmentCode/garmentCodeB/fabric/@listVersion) [Optional]

- nota: *this attribute should always be used coupled with “numberingOrg” and “listName”*  
 (XPath FASCatalog/FCbody/FCgroup/FCitem/fashionProd/garmentPartCode/fabric/@listVersion) [Optional]

- nota: *this attribute should always be used coupled with “numberingOrg” and “listName”*  
 (XPath FASCatalog/FCbody/FCgroup/FCitem/unitOfMeasure/@listVersion) [Optional]  
 (XPath FASCatalog/FCbody/FCgroup/FCitem/fashionProd/garmentPartCode/mod/@listVersion) [Optional]

- nota: *this attribute should always be used coupled with “numberingOrg” and “listName”*  
 (XPath FASCatalog/FCbody/FCgroup/FCitem/fashionProd/garmentPartCode/color/@listVersion) [Optional]

- nota: *this attribute should always be used coupled with “numberingOrg” and “listName”*  
 (XPath FASCatalog/FCbody/FCgroup/FCitem/fashionProd/garmentCode/garmentCodeB/mod/@listVersion) [Optional]

- nota: *this attribute should always be used coupled with “numberingOrg” and “listName”*  
 (XPath FASCatalog/FCbody/FCgroup/FCitem/fashionProd/csRange/garmentVariant/variantType/@listVersion) [Optional]

- nota: *this attribute should always be used coupled with “numberingOrg” and “listName”*  
 (XPath FASCatalog/FCbody/FCgroup/FCitem/fashionProd/csRange/garmentVariant/variantCode/@listVersion) [Optional]

- nota: *this attribute should always be used coupled with “numberingOrg” and “listName”*  
 (XPath FASCatalog/FCbody/FCgroup/FCitem/fashionProd/csRange/sizeMatrix/sizeRow/additionalComponentCode/@listVersion) [Optional]  
 (XPath FASCatalog/FCbody/FCgroup/refDoc/season/@listVersion) [Optional]  
 (XPath FASCatalog/FCbody/FCgroup/FCitem/measureConversion/unitOfSourceMeasure/@listVersion) [Optional]  
 (XPath FASCatalog/FCbody/FCgroup/FCitem/fashionProd/texCode/color/@listVersion) [Optional]

- nota: *this attribute should always be used coupled with “numberingOrg” and “listName”*

|  |  |
|--|--|
|  | <p>(XPath FASCatalog/FCbody/FCgroup/FCitem/fashionProd/acsCode/art/@listVersion) [Optional]<br/> - nota: <i>this attribute should always be used coupled with “numberingOrg” and “listName”</i></p> <p>(XPath FASCatalog/FCbody/FCgroup/FCitem/fashionProd/texCode/pattern/@listVersion) [Optional]<br/> - nota: <i>this attribute should always be used coupled with “numberingOrg” and “listName”</i></p> <p>(XPath FASCatalog/FCbody/FCgroup/FCitem/fashionProd/texCode/art/@listVersion) [Optional]<br/> - nota: <i>this attribute should always be used coupled with “numberingOrg” and “listName”</i></p> <p>(XPath FASCatalog/FCbody/FCgroup/FCitem/fashionProd/garmentCode/garmentCodeB/garmentVariant/variantType/@listVersion) [Optional]<br/> - nota: <i>this attribute should always be used coupled with “numberingOrg” and “listName”</i></p> <p>(XPath FASCatalog/FCbody/FCgroup/FCitem/fashionProd/garmentCode/garmentCodeB/color/@listVersion) [Optional]<br/> - nota: <i>this attribute should always be used coupled with “numberingOrg” and “listName”</i></p> <p>(XPath FASCatalog/FCbody/FCgroup/FCitem/measureConversion/unitOfTargetMeasure/@listVersion) [Optional]<br/> (XPath FASCatalog/FCbody/FCgroup/FCitem/fashionProd/acsCode/color/@listVersion) [Optional]<br/> - nota: <i>this attribute should always be used coupled with “numberingOrg” and “listName”</i></p> <p>(XPath FASCatalog/FCbody/FCgroup/FCitem/fashionProd/csRange/color/@listVersion) [Optional]<br/> - nota: <i>this attribute should always be used coupled with “numberingOrg” and “listName”</i></p> <p>(XPath FASCatalog/garComInfo/season/@listVersion) [Optional]<br/> (XPath FASCatalog/FCbody/FCgroup/FCitem/fashionProd/acsCode/pattern/@listVersion) [Optional]<br/> - nota: <i>this attribute should always be used coupled with “numberingOrg” and “listName”</i></p> <p>(XPath FASCatalog/FCbody/FCgroup/FCitem/garComInfo/season/@listVersion) [Optional]<br/> (XPath FASCatalog/FCbody/FCgroup/FCitem/fashionProd/garmentCode/garmentCodeB/artGroup/@listVersion) [Optional]<br/> - nota: <i>this attribute should always be used coupled with “numberingOrg” and “listName”</i></p> <p>(XPath FASCatalog/FCbody/FCgroup/FCitem/productLine/@listVersion) [Optional]<br/> (XPath FASCatalog/FCbody/FCgroup/FCitem/operationalCode/@listVersion) [Optional]<br/> (XPath FASCatalog/garComInfo/operationalCode/@listVersion) [Optional]<br/> (XPath FASCatalog/FCbody/FCgroup/FCitem/garmentCategory/artSex/@listVersion) [Optional]<br/> - nota: <i>this attribute should always be used coupled with “numberingOrg” and “listName”</i></p> <p>(XPath FASCatalog/FCbody/FCgroup/FCitem/garComInfo/brand/@listVersion) [Optional]<br/> (XPath FASCatalog/FCbody/FCgroup/FCitem/brand/@listVersion) [Optional]<br/> (XPath FASCatalog/FCbody/FCgroup/FCitem/garmentCategory/artGroup/@listVersion) [Optional]<br/> - nota: <i>this attribute should always be used coupled with “numberingOrg” and “listName”</i></p> <p>(XPath FASCatalog/FCbody/FCgroup/FCitem/fashionProd/garmentCode/garmentCodeA/art/@listVersion) [Optional]<br/> - nota: <i>this attribute should always be used coupled with “numberingOrg” and “listName”</i></p> <p>(XPath FASCatalog/FCbody/FCgroup/FCitem/garComInfo/operationalCode/@listVersion) [Optional]<br/> (XPath FASCatalog/FCbody/FCgroup/FCitem/refDoc/season/@listVersion) [Optional]</p> |
|--|--|

|            |   |
|------------|---|
|            | <p>(XPath FASCatalog/FCheader/refDoc/season/@listVersion) [Optional]<br/> (XPath FASCatalog/garComInfo/productLine/@listVersion) [Optional]<br/> (XPath FASCatalog/FCbody/FCgroup/FCitem/garmentCategory/artSubGroup/@listVersion) [Optional]<br/> - nota: <i>this attribute should always be used coupled with “numberingOrg” and “listName”</i><br/> (XPath FASCatalog/FCbody/FCgroup/FCitem/garComInfo/productLine/@listVersion) [Optional]</p>  |
| @ln        | <p>Language code.<br/> - base type: string,<br/> (XPath FASCatalog/FCbody/FCgroup/description/@ln) [Optional]<br/> (XPath FASCatalog/FCbody/FCgroup/FCitem/fashionProd/yarnCode/description/@ln) [Optional]<br/> (XPath FASCatalog/FCbody/FCgroup/FCitem/fashionProd/acsCode/description/@ln) [Optional]<br/> (XPath FASCatalog/FCbody/FCgroup/FCitem/picture/alternativeText/@ln) [Optional]<br/> (XPath FASCatalog/FCbody/FCgroup/FCitem/picture/description/@ln) [Optional]<br/> (XPath FASCatalog/FCbody/FCgroup/FCitem/composition/description/@ln) [Optional]<br/> (XPath FASCatalog/FCbody/FCgroup/FCitem/extendedDescription/@ln) [Optional]<br/> (XPath FASCatalog/FCbody/FCgroup/FCitem/picture/title/@ln) [Optional]<br/> (XPath FASCatalog/FCbody/FCgroup/FCitem/fashionProd/garmentCode/garmentCodeB/description/@ln) [Optional]<br/> (XPath FASCatalog/FCheader/picture/description/@ln) [Optional]<br/> (XPath FASCatalog/FCheader/picture/title/@ln) [Optional]<br/> (XPath FASCatalog/FCbody/FCgroup/FCitem/fashionProd/garmentPartCode/description/@ln) [Optional]<br/> (XPath FASCatalog/FCbody/FCgroup/FCitem/fashionProd/texCode/description/@ln) [Optional]<br/> (XPath FASCatalog/FCbody/FCgroup/FCitem/packages/handlingChar/handlingType/@ln) [Optional]<br/> (XPath FASCatalog/FCbody/FCgroup/FCitem/fashionProd/garmentCode/garmentCodeA/description/@ln) [Optional]<br/> (XPath FASCatalog/FCheader/picture/alternativeText/@ln) [Optional]<br/> (XPath FASCatalog/FCbody/FCgroup/picture/alternativeText/@ln) [Optional]<br/> (XPath FASCatalog/FCbody/FCgroup/picture/description/@ln) [Optional]<br/> (XPath FASCatalog/FCbody/FCgroup/FCitem/packages/description/@ln) [Optional]<br/> (XPath FASCatalog/FCbody/FCgroup/extendedDescription/@ln) [Optional]<br/> (XPath FASCatalog/FCbody/FCgroup/picture/title/@ln) [Optional]</p> |
| location   | <p>specification of a location<br/> - base type: string, max length: 40,<br/> (XPath FASCatalog/terms/trade/location) 0-1<br/> - note: <i>place to which the INCOTERM applies</i></p>   |
| @logo      | <p>company logo (URL of the image jpeg or gif). It is recommended that the width of the image does not exceed 640 pixel.<br/> - base type: string, max length: 255,<br/> (XPath FASCatalog/FCheader/buyer/@logo) [Optional]<br/> (XPath FASCatalog/FCheader/supplier/@logo) [Optional]</p>  |
| @LRI       | <p>attribute usable to format a string according to a customized User rule (local rule)<br/> - base type: string, cod. table: NT3<br/> <a href="http://www.ebiz.enea.it/moda-ml/repository/codelist/draft/gc_NT3.xml">http://www.ebiz.enea.it/moda-ml/repository/codelist/draft/gc_NT3.xml</a><br/> (XPath FASCatalog/terms/trade/location/@LRI) [Optional]</p>   |
| macroClass | <p>a code indicating the category (macro-class, class or sub-class) of a commodity classification system the article belongs to.<br/> - base type: string,<br/> (XPath FASCatalog/FCbody/FCgroup/FCitem/garmentCategory/goodsClassification/macroClass) 0-1</p>   |

|                           |   |
|---------------------------|---|
| <b>@maxQty</b>            | <p>maximum product quantity</p> <ul style="list-style-type: none"> <li>- base type: decimal, min inclusive: 0, fraction digits: 2,<br/>(XPath FASCatalog/FCbody/FCgroup/allowanceCharge/@maxQty) [Optional]</li> <li>- nota: <i>maximum quantity of product for the application of this allowance or charge</i><br/>(XPath FASCatalog/terms/allowanceCharge/@maxQty) [Optional]</li> <li>- nota: <i>maximum quantity of product for the application of this allowance or charge</i><br/>(XPath FASCatalog/FCbody/FCgroup/FCitem/marketPrice/allowanceCharge/@maxQty) [Optional]</li> <li>- nota: <i>maximum quantity of product for the application of this allowance or charge</i><br/>(XPath FASCatalog/FCbody/FCgroup/FCitem/allowanceCharge/@maxQty) [Optional]</li> <li>- nota: <i>maximum quantity of product for the application of this allowance or charge</i><br/>(XPath FASCatalog/FCbody/FCgroup/FCitem/marketPrice/catalogPrice/@maxQty) [Optional]</li> <li>- nota: <i>maximum quantity of product for the application of this price</i></li> </ul> |
| <b>@measureQualifier</b>  | <p>Unit of measure qualifier.</p> <ul style="list-style-type: none"> <li>- base type: string,<br/>(XPath FASCatalog/FCbody/FCgroup/FCitem/measureConversion/unitOfTargetMeasure/@measureQualifier) [Optional]</li> <li>(XPath FASCatalog/FCbody/FCgroup/FCitem/measureConversion/unitOfSourceMeasure/@measureQualifier) [Optional]</li> <li>(XPath FASCatalog/FCbody/FCgroup/FCitem/unitOfMeasure/@measureQualifier) [Optional]</li> </ul>  |
| <b>@mime</b>              | <p>the mime type of the binary object</p> <ul style="list-style-type: none"> <li>- base type: normalizedString,<br/>(XPath FASCatalog/FCheader/picture/attachment/binaryObject/@mime) [Optional]</li> <li>(XPath FASCatalog/FCbody/FCgroup/FCitem/refDoc/attachment/binaryObject/@mime) [Optional]</li> <li>(XPath FASCatalog/FCbody/FCgroup/FCitem/picture/attachment/binaryObject/@mime) [Optional]</li> <li>(XPath FASCatalog/FCheader/refDoc/attachment/binaryObject/@mime) [Optional]</li> <li>(XPath FASCatalog/FCbody/FCgroup/refDoc/attachment/binaryObject/@mime) [Optional]</li> <li>(XPath FASCatalog/FCbody/FCgroup/picture/attachment/binaryObject/@mime) [Optional]</li> </ul>  |
| <b>mimeCode</b>           | <p>mime type of the external object</p> <ul style="list-style-type: none"> <li>- base type: normalizedString,<br/>(XPath FASCatalog/FCbody/FCgroup/refDoc/attachment/externalReference/mimeCode) 0-1</li> <li>(XPath FASCatalog/FCbody/FCgroup/picture/attachment/externalReference/mimeCode) 0-1</li> <li>(XPath FASCatalog/FCheader/refDoc/attachment/externalReference/mimeCode) 0-1</li> <li>(XPath FASCatalog/FCheader/picture/attachment/externalReference/mimeCode) 0-1</li> <li>(XPath FASCatalog/FCbody/FCgroup/FCitem/refDoc/attachment/externalReference/mimeCode) 0-1</li> <li>(XPath FASCatalog/FCbody/FCgroup/FCitem/picture/attachment/externalReference/mimeCode) 0-1</li> </ul>  |
| <b>minItemsPerPackage</b> | <p>the minimum quantity of items for the specified kind of package.</p> <ul style="list-style-type: none"> <li>- base type: decimal, min inclusive: 0,<br/>(XPath FASCatalog/FCbody/FCgroup/FCitem/packages/minItemsPerPackage) 0-1</li> </ul>  |
| <b>@minQty</b>            | <p>minimum product quantity</p> <ul style="list-style-type: none"> <li>- base type: decimal, min inclusive: 0, fraction digits: 2,<br/>(XPath FASCatalog/terms/allowanceCharge/@minQty) [Optional]</li> </ul>   |

|               |   |
|---------------|---|
|               | <p>- nota: <i>minimum quantity of product for the application of this allowance or charge</i><br/>(XPath FASCatalog/FCbody/FCgroup/FCitem/marketPrice/catalogPrice/@minQty) [Optional]</p> <p>- nota: <i>minimum quantity of product for the application of this price</i><br/>(XPath FASCatalog/FCbody/FCgroup/FCitem/marketPrice/allowanceCharge/@minQty) [Optional]</p> <p>- nota: <i>minimum quantity of product for the application of this allowance or charge</i><br/>(XPath FASCatalog/FCbody/FCgroup/FCitem/allowanceCharge/@minQty) [Optional]</p> <p>- nota: <i>minimum quantity of product for the application of this allowance or charge</i><br/>(XPath FASCatalog/FCbody/FCgroup/allowanceCharge/@minQty) [Optional]</p> <p>- nota: <i>minimum quantity of product for the application of this allowance or charge</i></p> |
| mod           | <p>model number of the garment</p> <p>- base type: string, max length: 15,<br/>(XPath FASCatalog/FCbody/FCgroup/FCitem/fashionProd/garmentPartCode/mod) 1-1</p> <p>- note: <i>when a garment component, it should be the code assigned to the garment article</i><br/>(XPath FASCatalog/FCbody/FCgroup/FCitem/fashionProd/garmentCode/garmentCodeB/mod) 1-1</p>   |
| msgCurrency   | <p>currency used to express the monetary amounts of the message</p> <p>- base type: string, cod. table: T9<br/><a href="http://www.ebiz.enea.it/moda-ml/repository/codelist/draft/gc_T9.xml">http://www.ebiz.enea.it/moda-ml/repository/codelist/draft/gc_T9.xml</a><br/>(XPath FASCatalog/FCheader/msgCurrency) 0-1</p>  |
| msgDate       | <p>date of issue of the present message (xml document), according to one of the patterns YYYY-MM-DD, YYYY-MM-DD:HH-MM or YYYY-WW.</p> <p>- base type: string,<br/>(XPath FASCatalog/FCheader/msgDate) 1-1</p>   |
| msgID         | <p>key identifier of the business document in the information system of the issuing Party. In case of more despatches of the same business document, it is unchanged.</p> <p>- base type: string, max length: 35,<br/>(XPath FASCatalog/FCheader/msgID) 0-1</p>   |
| msgN          | <p>identification number given to the message (xml document) by its issuer. In case of more despatches of the same business document, it changes.</p> <p>- base type: string, max length: 35,<br/>(XPath FASCatalog/FCheader/msgN) 1-1</p>  |
| netWeight     | <p>the net weight declared for transport or customs purpose</p> <p>- base type: decimal, min inclusive: 0, fraction digits: 2,<br/>(XPath FASCatalog/FCbody/FCgroup/FCitem/packages/handlingChar/netWeight) 0-1<br/>(XPath FASCatalog/terms/transInfo/netWeight) 0-1</p>  |
| nominalHeight | <p>nominal height of a specified object</p> <p>- base type: decimal, min inclusive: 0, fraction digits: 2,<br/>(XPath FASCatalog/FCheader/picture/nominalHeight) 0-2</p> <p>- note: <i>Only one instance of this element for each different value of 'um' attribute (unit of measure)</i><br/>(XPath FASCatalog/FCbody/FCgroup/FCitem/picture/nominalHeight) 0-2</p> <p>- note: <i>Only one instance of this element for each different value of 'um' attribute (unit of measure)</i><br/>(XPath FASCatalog/FCbody/FCgroup/picture/nominalHeight) 0-2</p> <p>- note: <i>Only one instance of this element for each different value of 'um' attribute (unit of measure)</i></p>  |

|              |  |
|--------------|--|
| nominalWidth | <p>nominal width of a specified object</p> <ul style="list-style-type: none"> <li>- base type: decimal, min inclusive: 0, fraction digits: 2,<br/>(XPath FASCatalog/FCbody/FCgroup/FCitem/picture/nominalWidth) 0-2</li> <li>- note: <i>Only one instance of this element for each different value of 'um' attribute (unit of measure)</i><br/>(XPath FASCatalog/FCbody/FCgroup/picture/nominalWidth) 0-2</li> <li>- note: <i>Only one instance of this element for each different value of 'um' attribute (unit of measure)</i><br/>(XPath FASCatalog/FCheader/picture/nominalWidth) 0-2</li> <li>- note: <i>Only one instance of this element for each different value of 'um' attribute (unit of measure)</i></li> </ul>  |
| note         | <p>free text or structured (computer processing) note. For note structuring use the attributes "noteLabel" and "codelist"</p> <ul style="list-style-type: none"> <li>- base type: string, max length: 350,<br/>(XPath FASCatalog/FCheader/picture/note) 0-99<br/>(XPath FASCatalog/FCbody/FCgroup/picture/note) 0-99<br/>(XPath FASCatalog/FCbody/FCgroup/FCitem/garComInfo/note) 0-99<br/>(XPath FASCatalog/FCbody/FCgroup/note) 0-99<br/>(XPath FASCatalog/FCbody/FCgroup/FCitem/picture/note) 0-99<br/>(XPath FASCatalog/FCbody/FCgroup/FCitem/note) 0-99<br/>(XPath FASCatalog/FCbody/FCgroup/garComInfo/note) 0-99<br/>(XPath FASCatalog/FCbody/FCgroup/FCitem/fashionProd/note) 0-unbounded<br/>(XPath FASCatalog/FCheader/note) 0-99<br/>(XPath FASCatalog/FCbody/FCgroup/FCitem/garmentCategory/note) 0-99<br/>(XPath FASCatalog/FCbody/FCgroup/FCitem/allowanceCharge/dtScheme/note) 0-99<br/>(XPath FASCatalog/FCbody/FCgroup/FCitem/marketPrice/allowanceCharge/dtScheme/note) 0-99<br/>(XPath FASCatalog/terms/allowanceCharge/dtScheme/note) 0-99<br/>(XPath FASCatalog/FCbody/FCgroup/FCitem/dtScheme/note) 0-99<br/>(XPath FASCatalog/FCbody/FCgroup/allowanceCharge/dtScheme/note) 0-99<br/>(XPath FASCatalog/garComInfo/note) 0-99<br/>(XPath FASCatalog/FCbody/FCgroup/FCitem/packages/handlingChar/note) 0-99</li> </ul>  |
| @noteLabel   | <p>subject qualifier of a note</p> <ul style="list-style-type: none"> <li>- base type: string, max length: 35,<br/>(XPath FASCatalog/FCbody/FCgroup/FCitem/note/@noteLabel) [Optional]</li> <li>- nota: <i>must be used to qualify the subject of the note</i><br/>(XPath FASCatalog/FCbody/FCgroup/note/@noteLabel) [Optional]</li> <li>- nota: <i>must be used to qualify the subject of the note</i><br/>(XPath FASCatalog/garComInfo/note/@noteLabel) [Optional]</li> <li>- nota: <i>must be used to qualify the subject of the note</i><br/>(XPath FASCatalog/FCbody/FCgroup/garComInfo/note/@noteLabel) [Optional]</li> <li>- nota: <i>must be used to qualify the subject of the note</i><br/>(XPath FASCatalog/terms/allowanceCharge/dtScheme/note/@noteLabel) [Optional]</li> <li>- nota: <i>must be used to qualify the subject of the note</i><br/>(XPath FASCatalog/FCbody/FCgroup/FCitem/allowanceCharge/dtScheme/note/@noteLabel) [Optional]</li> <li>- nota: <i>must be used to qualify the subject of the note</i><br/>(XPath FASCatalog/FCbody/FCgroup/FCitem/marketPrice/allowanceCharge/dtScheme/note/@noteLabel) [Optional]</li> <li>- nota: <i>must be used to qualify the subject of the note</i><br/>(XPath FASCatalog/FCheader/note/@noteLabel) [Optional]</li> <li>- nota: <i>must be used to qualify the subject of the note</i><br/>(XPath FASCatalog/FCbody/FCgroup/FCitem/picture/note/@noteLabel) [Optional]</li> <li>- nota: <i>must be used to qualify the subject of the note</i><br/>(XPath FASCatalog/FCbody/FCgroup/allowanceCharge/dtScheme/note/@noteLabel) [Optional]</li> <li>- nota: <i>must be used to qualify the subject of the note</i><br/>(XPath FASCatalog/FCbody/FCgroup/FCitem/packages/handlingChar/note/@noteLabel) [Optional]</li> <li>- nota: <i>must be used to qualify the subject of the note</i><br/>(XPath FASCatalog/FCbody/FCgroup/FCitem/garComInfo/note/@noteLabel) [Optional]</li> </ul> |



|               |   |
|---------------|---|
|               | <ul style="list-style-type: none"> <li>- nota: <i>must be used to qualify the subject of the note</i><br/>(XPath FASCatalog/FCbody/FCgroup/FCitem/garmentCategory/<br/>note/@noteLabel) [Optional]</li> <li>- nota: <i>must be used to qualify the subject of the note</i><br/>(XPath FASCatalog/FCbody/FCgroup/FCitem/dtScheme/note/@noteLabel) [Optional]</li> <li>- nota: <i>must be used to qualify the subject of the note</i><br/>(XPath FASCatalog/FCbody/FCgroup/FCitem/fashionProd/note/@noteLabel) [Optional]</li> <li>- nota: <i>must be used to qualify the subject of the note</i><br/>(XPath FASCatalog/FCbody/FCgroup/picture/note/@noteLabel) [Optional]</li> <li>- nota: <i>must be used to qualify the subject of the note</i><br/>(XPath FASCatalog/FCheader/picture/note/@noteLabel) [Optional]</li> <li>- nota: <i>must be used to qualify the subject of the note</i></li> </ul>  |
| @numberingOrg | <p>code specifying the organisation who has created or owns the coding or numbering system</p> <ul style="list-style-type: none"> <li>- base type: string, cod. table: NT6<br/><a href="http://www.ebiz.enea.it/moda-ml/repository/codelist/draft/gc_NT6.xml">http://www.ebiz.enea.it/moda-ml/repository/codelist/draft/gc_NT6.xml</a><br/>(XPath FASCatalog/garComInfo/season/@numberingOrg) [Optional]<br/>(XPath FASCatalog/FCbody/FCgroup/FCitem/fashionProd/<br/>csRange/color/@numberingOrg) [Optional]</li> <li>- nota: <i>this attribute should be used either single or coupled with "listName" and "listVersion"</i><br/>(XPath FASCatalog/garComInfo/brand/@numberingOrg) [Optional]<br/>(XPath FASCatalog/FCbody/FCgroup/FCitem/fashionProd/<br/>csRange/@numberingOrg) [Optional]<br/>(XPath FASCatalog/garComInfo/productLine/@numberingOrg) [Optional]<br/>(XPath FASCatalog/FCbody/FCgroup/FCitem/fashionProd/<br/>csRange/garmentVariant/variantType/@numberingOrg) [Optional]</li> <li>- nota: <i>this attribute should be used either single or coupled with "listName" and "listVersion"</i><br/>(XPath FASCatalog/FCbody/FCgroup/FCitem/fashionProd/<br/>garmentCode/garmentCodeA/art/@numberingOrg) [Optional]</li> <li>- nota: <i>this attribute should be used either single or coupled with "listName" and "listVersion"</i><br/>(XPath FASCatalog/FCbody/FCgroup/FCitem/garComInfo/season/@numberingOrg) [Optional]<br/>(XPath FASCatalog/FCbody/FCgroup/FCitem/allowanceCharge/<br/>dtScheme/note/@numberingOrg) [Optional]<br/>(XPath FASCatalog/FCbody/FCgroup/FCitem/garComInfo/<br/>productLine/@numberingOrg) [Optional]<br/>(XPath FASCatalog/FCbody/FCgroup/FCitem/garComInfo/brand/@numberingOrg) [Optional]<br/>(XPath FASCatalog/FCheader/picture/note/@numberingOrg) [Optional]<br/>(XPath FASCatalog/FCheader/season/@numberingOrg) [Optional]<br/>(XPath FASCatalog/FCbody/FCgroup/FCitem/marketPrice/<br/>allowanceCharge/dtScheme/note/@numberingOrg) [Optional]<br/>(XPath FASCatalog/FCheader/picture/attachment/fileName/@numberingOrg) [Optional]<br/>(XPath FASCatalog/FCbody/FCgroup/FCitem/dtScheme/note/@numberingOrg) [Optional]<br/>(XPath FASCatalog/FCheader/refDoc/docID/@numberingOrg) [Optional]</li> <li>- nota: <i>here can be specified whose document numbering is used (e.g.: Client, Supplier, ..)</i><br/>(XPath FASCatalog/FCbody/FCgroup/note/@numberingOrg) [Optional]<br/>(XPath FASCatalog/FCbody/FCgroup/FCitem/note/@numberingOrg) [Optional]<br/>(XPath FASCatalog/FCheader/refDoc/attachment/fileName/@numberingOrg) [Optional]<br/>(XPath FASCatalog/FCbody/FCgroup/FCitem/garComInfo/<br/>operationalCode/@numberingOrg) [Optional]<br/>(XPath FASCatalog/FCbody/FCgroup/FCitem/garComInfo/note/@numberingOrg) [Optional]<br/>(XPath FASCatalog/FCheader/refDoc/season/@numberingOrg) [Optional]<br/>(XPath FASCatalog/FCbody/FCgroup/FCitem/fashionProd/note/@numberingOrg) [Optional]</li> </ul> |

|  |  |
|--|--|
|  | <p>(XPath FASCatalog/FCbody/FCgroup/FCitem/fashionProd/csRange/sizeMatrix/sizeRow/itemsList/itemIdentification/serialN/@numberingOrg) [Optional]<br/> - nota: <i>here the issuer of the serial number must be specified (when different from the Supplier)</i></p> <p>(XPath FASCatalog/FCbody/FCgroup/FCitem/packages/packageModelCode/@numberingOrg) [Optional]<br/> (XPath FASCatalog/FCheader/note/@numberingOrg) [Optional]<br/> (XPath FASCatalog/terms/allowanceCharge/dtScheme/note/@numberingOrg) [Optional]</p> <p>(XPath FASCatalog/FCbody/FCgroup/FCitem/fashionProd/csRange/garmentVariant/variantCode/@numberingOrg) [Optional]<br/> - nota: <i>this attribute should be used either single or coupled with "listName" and "listVersion"</i></p> <p>(XPath FASCatalog/FCbody/FCgroup/FCitem/fashionProd/csRange/sizeMatrix/sizeRow/itemsList/qualityLevel/@numberingOrg) [Optional]</p> <p>(XPath FASCatalog/FCbody/FCgroup/FCitem/fashionProd/csRange/sizeMatrix/sizeRow/additionalComponentCode/@numberingOrg) [Optional]<br/> (XPath FASCatalog/FCbody/FCgroup/FCitem/packages/packageN/@numberingOrg) [Optional]<br/> (XPath FASCatalog/FCheader/buyer/additionalIdentifier/@numberingOrg) [Optional]<br/> - nota: <i>here the issuer of the identifier must be specified</i></p> <p>(XPath FASCatalog/FCbody/FCgroup/FCitem/packages/EPClist/EPC/@numberingOrg) [Optional]<br/> (XPath FASCatalog/FCheader/buyer/id/@numberingOrg) [Optional]<br/> (XPath FASCatalog/FCheader/supplier/additionalIdentifier/@numberingOrg) [Optional]<br/> - nota: <i>here the issuer of the identifier must be specified</i></p> <p>(XPath FASCatalog/FCheader/thirdParty/id/@numberingOrg) [Optional]<br/> (XPath FASCatalog/FCbody/FCgroup/FCitem/packages/handlingChar/note/@numberingOrg) [Optional]<br/> (XPath FASCatalog/FCheader/supplier/id/@numberingOrg) [Optional]<br/> (XPath FASCatalog/FCbody/FCgroup/FCitem/fashionProd/garmentPartCode/@numberingOrg) [Optional]<br/> (XPath FASCatalog/FCbody/FCgroup/FCitem/garmentCategory/goodsClassification/subClass/@numberingOrg) [Optional]<br/> (XPath FASCatalog/FCbody/FCgroup/FCitem/fashionProd/garmentPartCode/mod/@numberingOrg) [Optional]<br/> - nota: <i>this attribute should be ALTERNATIVE to the others</i></p> <p>(XPath FASCatalog/FCbody/FCgroup/FCitem/garmentCategory/goodsClassification/class/@numberingOrg) [Optional]<br/> (XPath FASCatalog/FCbody/FCgroup/FCitem/fashionProd/acsCode/added/@numberingOrg) [Optional]<br/> (XPath FASCatalog/FCbody/FCgroup/FCitem/fashionProd/acsCode/color/@numberingOrg) [Optional]<br/> - nota: <i>this attribute should be used either single or coupled with "listName" and "listVersion"</i></p> <p>(XPath FASCatalog/FCbody/FCgroup/picture/attachment/fileName/@numberingOrg) [Optional]<br/> (XPath FASCatalog/FCbody/FCgroup/garComInfo/note/@numberingOrg) [Optional]<br/> (XPath FASCatalog/FCbody/FCgroup/FCitem/garmentCategory/note/@numberingOrg) [Optional]<br/> (XPath FASCatalog/FCbody/FCgroup/FCitem/refDoc/docID/@numberingOrg) [Optional]<br/> - nota: <i>here can be specified whose document numbering is used (e.g.: Client, Supplier, ..)</i></p> <p>(XPath FASCatalog/FCbody/FCgroup/FCitem/garmentCategory/artSex/@numberingOrg) [Optional]<br/> - nota: <i>this attribute should be used either single or coupled with "listName" and "listVersion"</i></p> <p>(XPath FASCatalog/FCbody/FCgroup/FCitem/refDoc/attachment/fileName/@numberingOrg) [Optional]<br/> (XPath FASCatalog/FCbody/FCgroup/FCitem/garmentCategory/artGroup/@numberingOrg) [Optional]</p> |
|--|--|



- nota: *this attribute should be used either single or coupled with "listName" and "listVersion"*  
 (XPath FASCatalog/FCbody/FCgroup/FCitem/garmentCategory/artSubGroup/@numberingOrg) [Optional]

- nota: *this attribute should be used either single or coupled with "listName" and "listVersion"*  
 (XPath FASCatalog/FCbody/FCgroup/FCitem/garmentCategory/season/@numberingOrg) [Optional]  
 (XPath FASCatalog/FCbody/FCgroup/FCitem/refDoc/season/@numberingOrg) [Optional]  
 (XPath FASCatalog/FCbody/FCgroup/FCitem/fashionProd/garmentPartCode/fabric/@numberingOrg) [Optional]

- nota: *this attribute should be used either single or coupled with "listName" and "listVersion"*  
 (XPath FASCatalog/FCbody/FCgroup/FCitem/fashionProd/garmentPartCode/color/@numberingOrg) [Optional]

- nota: *this attribute should be used either single or coupled with "listName" and "listVersion"*  
 (XPath FASCatalog/FCbody/FCgroup/FCitem/garmentCategory/goodsClassification/macroClass/@numberingOrg) [Optional]  
 (XPath FASCatalog/FCbody/FCgroup/allowanceCharge/dtScheme/note/@numberingOrg) [Optional]  
 (XPath FASCatalog/FCbody/FCgroup/FCitem/fashionProd/texCode/pattern/@numberingOrg) [Optional]

- nota: *this attribute should be used either single or coupled with "listName" and "listVersion"*  
 (XPath FASCatalog/FCbody/FCgroup/FCitem/fashionProd/texCode/@numberingOrg) [Optional]  
 (XPath FASCatalog/FCbody/FCgroup/FCitem/fashionProd/texCode/art/@numberingOrg) [Optional]

- nota: *this attribute should be used either single or coupled with "listName" and "listVersion"*  
 (XPath FASCatalog/FCbody/FCgroup/FCitem/fashionProd/texCode/color/@numberingOrg) [Optional]

- nota: *this attribute should be used either single or coupled with "listName" and "listVersion"*  
 (XPath FASCatalog/FCbody/FCgroup/picture/note/@numberingOrg) [Optional]  
 (XPath FASCatalog/FCbody/FCgroup/FCitem/fashionProd/acsCode/@numberingOrg) [Optional]  
 (XPath FASCatalog/FCbody/FCgroup/FCitem/fashionProd/texCode/added/@numberingOrg) [Optional]  
 (XPath FASCatalog/FCbody/FCgroup/FCitem/fashionProd/acsCode/art/@numberingOrg) [Optional]

- nota: *this attribute should be used either single or coupled with "listName" and "listVersion"*  
 (XPath FASCatalog/FCbody/FCgroup/garComInfo/season/@numberingOrg) [Optional]  
 (XPath FASCatalog/FCbody/FCgroup/FCitem/fashionProd/yarnCode/@numberingOrg) [Optional] [Default= CL]  
 (XPath FASCatalog/FCbody/FCgroup/FCitem/fashionProd/yarnCode/art/@numberingOrg) [Optional]

- nota: *this attribute should be used either single or coupled with "listName" and "listVersion"*  
 (XPath FASCatalog/FCbody/FCgroup/FCitem/fashionProd/additionalComponentCode/@numberingOrg) [Optional]  
 (XPath FASCatalog/FCbody/FCgroup/garComInfo/operationalCode/@numberingOrg) [Optional]  
 (XPath FASCatalog/FCbody/FCgroup/garComInfo/productLine/@numberingOrg) [Optional]  
 (XPath FASCatalog/FCbody/FCgroup/garComInfo/brand/@numberingOrg) [Optional]  
 (XPath FASCatalog/FCbody/FCgroup/FCitem/fashionProd/yarnCode/added/@numberingOrg) [Optional]  
 (XPath FASCatalog/FCbody/FCgroup/FCitem/fashionProd/acsCode/pattern/@numberingOrg) [Optional]

|                 |   |
|-----------------|---|
|                 | <p>- nota: <i>this attribute should be used either single or coupled with "listName" and "listVersion"</i><br/> (XPath FASCatalog/FCbody/FCgroup/FCitem/fashionProd/yarnCode/color/@numberingOrg) [Optional]</p> <p>- nota: <i>this attribute should be used either single or coupled with "listName" and "listVersion"</i><br/> (XPath FASCatalog/FCbody/FCgroup/FCitem/fashionProd/garmentPartCode/added/@numberingOrg) [Optional]<br/> (XPath FASCatalog/FCbody/FCgroup/refDoc/attachment/fileName/@numberingOrg) [Optional]<br/> (XPath FASCatalog/FCbody/FCgroup/FCitem/fashionProd/garmentCode/garmentCodeB/garmentVariant/variantCode/@numberingOrg) [Optional]</p> <p>- nota: <i>this attribute should be used either single or coupled with "listName" and "listVersion"</i><br/> (XPath FASCatalog/garComInfo/operationalCode/@numberingOrg) [Optional]<br/> (XPath FASCatalog/garComInfo/note/@numberingOrg) [Optional]<br/> (XPath FASCatalog/FCbody/FCgroup/FCitem/fashionProd/garmentCode/@numberingOrg) [Optional]<br/> (XPath FASCatalog/FCbody/FCgroup/FCitem/fashionProd/garmentCode/garmentCodeB/@numberingOrg) [Optional]<br/> (XPath FASCatalog/FCbody/FCgroup/refDoc/season/@numberingOrg) [Optional]<br/> (XPath FASCatalog/FCbody/FCgroup/artGroup/@numberingOrg) [Optional]</p> <p>- nota: <i>this attribute should be used either single or coupled with "listName" and "listVersion"</i><br/> (XPath FASCatalog/FCbody/FCgroup/FCitem/fashionProd/garmentCode/garmentCodeB/color/@numberingOrg) [Optional]</p> <p>- nota: <i>this attribute should be used either single or coupled with "listName" and "listVersion"</i><br/> (XPath FASCatalog/FCbody/FCgroup/FCitem/fashionProd/garmentCode/garmentCodeB/mod/@numberingOrg) [Optional]</p> <p>- nota: <i>this attribute should be ALTERNATIVE to the others</i><br/> (XPath FASCatalog/FCbody/FCgroup/FCitem/picture/attachment/fileName/@numberingOrg) [Optional]<br/> (XPath FASCatalog/FCbody/FCgroup/FCitem/operationalCode/@numberingOrg) [Optional]<br/> (XPath FASCatalog/FCbody/FCgroup/refDoc/docID/@numberingOrg) [Optional]</p> <p>- nota: <i>here can be specified whose document numbering is used (e.g.: Client, Supplier, ..)</i><br/> (XPath FASCatalog/FCbody/FCgroup/FCitem/garmentCategory/@numberingOrg) [Optional]<br/> (XPath FASCatalog/FCbody/FCgroup/FCitem/fashionProd/garmentCode/garmentCodeB/fabric/@numberingOrg) [Optional]</p> <p>- nota: <i>this attribute should be used either single or coupled with "listName" and "listVersion"</i><br/> (XPath FASCatalog/FCbody/FCgroup/FCitem/productLine/@numberingOrg) [Optional]<br/> (XPath FASCatalog/FCbody/FCgroup/FCitem/fashionProd/garmentCode/garmentCodeB/garmentVariant/variantType/@numberingOrg) [Optional]</p> <p>- nota: <i>this attribute should be used either single or coupled with "listName" and "listVersion"</i><br/> (XPath FASCatalog/FCbody/FCgroup/FCitem/fashionProd/garmentCode/garmentCodeB/added/@numberingOrg) [Optional]<br/> (XPath FASCatalog/FCbody/FCgroup/FCitem/brand/@numberingOrg) [Optional]<br/> (XPath FASCatalog/FCbody/FCgroup/FCitem/picture/note/@numberingOrg) [Optional]<br/> (XPath FASCatalog/FCbody/FCgroup/FCitem/fashionProd/garmentCode/garmentCodeB/artGroup/@numberingOrg) [Optional]</p> <p>- nota: <i>this attribute should be used either single or coupled with "listName" and "listVersion"</i></p> |
| operationalCode | operational code: it is the code of a project, an event, an initiative, a sales channel, a management type (eg CITES), ... the document, or product, is con   |

|                    |   |
|--------------------|---|
|                    | <p>nected with.</p> <ul style="list-style-type: none"> <li>- base type: string,</li> </ul> <p>(XPath FASCatalog/FCbody/FCgroup/FCitem/garComInfo/operationalCode) 0-19<br/> (XPath FASCatalog/garComInfo/operationalCode) 0-19<br/> (XPath FASCatalog/FCbody/FCgroup/garComInfo/operationalCode) 0-19<br/> (XPath FASCatalog/FCbody/FCgroup/FCitem/operationalCode) 0-9</p>   |
| package            | <p>code specifying the type of transport package</p> <ul style="list-style-type: none"> <li>- base type: string, cod. table: T11</li> </ul> <p><a href="http://www.ebiz.enea.it/moda-ml/repository/codelist/draft/gc_T11.xml">http://www.ebiz.enea.it/moda-ml/repository/codelist/draft/gc_T11.xml</a><br/> (XPath FASCatalog/FCbody/FCgroup/FCitem/packages/package) 1-1</p>   |
| @packageContainerN | <p>reference usable to indicate the outer package containing this package</p> <ul style="list-style-type: none"> <li>- base type: string, max length: 40,</li> </ul> <p>(XPath FASCatalog/FCbody/FCgroup/FCitem/packages/packageN/@packageContainerN) [Optional]</p>  |
| @packageLevel      | <p>level used to indicate the hierarchical structure of the packages (from outer to inner levels)</p> <ul style="list-style-type: none"> <li>- base type: positiveInteger, min inclusive: 1, max inclusive: 9,</li> </ul> <p>(XPath FASCatalog/FCbody/FCgroup/FCitem/packages/@packageLevel) [Optional]</p> <p>- nota: <i>number fixing the level of the package in the transport structure (from inner to outer). Must either be used for all package types or not be used</i></p> |
| packageModelCode   | <p>a code (eg a barcode) identifying the type of packaging</p> <ul style="list-style-type: none"> <li>- base type: string,</li> </ul> <p>(XPath FASCatalog/FCbody/FCgroup/FCitem/packages/packageModelCode) 0-1</p>   |
| packageN           | <p>serial number used to identify a transport package</p> <ul style="list-style-type: none"> <li>- base type: string, max length: 40,</li> </ul> <p>(XPath FASCatalog/FCbody/FCgroup/FCitem/packages/packageN) 0-unbounded</p> <p>- note: <i>here the serial no.s of the packages can be identified</i></p>   |
| packageQty         | <p>quantity of the specified transport packages</p> <ul style="list-style-type: none"> <li>- base type: positiveInteger,</li> </ul> <p>(XPath FASCatalog/FCbody/FCgroup/FCitem/packages/packageQty) 0-1</p> <p>- note: <i>total for the type of package</i></p>   |
| packageText        | <p>denomination of the type of transport package (text)</p> <ul style="list-style-type: none"> <li>- base type: string, max length: 80,</li> </ul> <p>(XPath FASCatalog/FCbody/FCgroup/FCitem/packages/packageText) 1-1</p>   |
| @part              | <p>percent fraction of a total payment</p> <ul style="list-style-type: none"> <li>- base type: decimal, min inclusive: 1, max inclusive: 99, fraction digits: 2,</li> </ul> <p>(XPath FASCatalog/terms/insPayment/@part) [Required]</p> <p>- nota: <i>here the % value of each installment must be indicated</i></p>  |
| pattern            | <p>pattern/design number of the product, when not included in the article code</p> <ul style="list-style-type: none"> <li>- base type: string, max length: 15,</li> </ul> <p>(XPath FASCatalog/FCbody/FCgroup/FCitem/fashionProd/acsCode/pattern) 0-1<br/> (XPath FASCatalog/FCbody/FCgroup/FCitem/fashionProd/texCode/pattern) 0-1</p>   |
| payMode            | <p>way or means of payment</p> <ul style="list-style-type: none"> <li>- base type: string, cod. table: T2</li> </ul> <p><a href="http://www.ebiz.enea.it/moda-ml/repository/codelist/draft/gc_T2.xml">http://www.ebiz.enea.it/moda-ml/repository/codelist/draft/gc_T2.xml</a><br/> (XPath FASCatalog/terms/payment/payMode) 0-1<br/> (XPath FASCatalog/terms/insPayment/payMode) 0-1</p>  |
| payTerm            | <p>code specifying the terms or time by which the payment must be done</p> <ul style="list-style-type: none"> <li>- base type: string, cod. table: T1</li> </ul> <p><a href="http://www.ebiz.enea.it/moda-ml/repository/codelist/draft/gc_T1.xml">http://www.ebiz.enea.it/moda-ml/repository/codelist/draft/gc_T1.xml</a><br/> (XPath FASCatalog/terms/payment/payTerm) 1-1<br/> (XPath FASCatalog/terms/insPayment/payTerm) 1-1</p>  |

|                  |  |
|------------------|--|
| payTermText      | free text specifying the terms by which the payment must be done (time/mode or means)<br>- base type: string, max length: 250,<br>(XPath FASCatalog/terms/payment/payTermText) 1-1<br>(XPath FASCatalog/terms/insPayment/payTermText) 1-1  |
| percCompos       | fiber rate in the product composition<br>- base type: decimal, min inclusive: 0, max inclusive: 100, fraction digits: 2,<br>(XPath FASCatalog/FCbody/FCgroup/FCitem/composition/garmentCompos/percCompos) 1-99   |
| person           | name of the contact person within a Party<br>- base type: string, max length: 40,<br>(XPath FASCatalog/FCheader/supplier/person) 0-1<br>(XPath FASCatalog/FCheader/buyer/person) 0-1<br>(XPath FASCatalog/FCheader/thirdParty/person) 0-1  |
| @phone           | phone number of the contact person within a Party<br>- base type: string, max length: 35,<br>(XPath FASCatalog/FCheader/thirdParty/person/@phone) [Optional]<br>(XPath FASCatalog/FCheader/supplier/person/@phone) [Optional]<br>(XPath FASCatalog/FCheader/buyer/person/@phone) [Optional]  |
| pictureCode      | picture code (it might be shared among more files)<br>- base type: string, max length: 80,<br>(XPath FASCatalog/FCbody/FCgroup/FCitem/picture/pictureCode) 0-1<br>(XPath FASCatalog/FCheader/picture/pictureCode) 0-1<br>(XPath FASCatalog/FCbody/FCgroup/picture/pictureCode) 0-1   |
| pictureQualifier | qualifies the image from the business point of view (i.e. main image, detail image,...)<br>- base type: string,<br>(XPath FASCatalog/FCbody/FCgroup/FCitem/picture/pictureQualifier) 0-1<br>(XPath FASCatalog/FCheader/picture/pictureQualifier) 0-1<br>(XPath FASCatalog/FCbody/FCgroup/picture/pictureQualifier) 0-1   |
| pictureUse       | picture final use<br>- base type: string, cod. table: NT72<br><a href="http://www.ebiz.enea.it/moda-ml/repository/codelist/draft/gc_NT72.xml">http://www.ebiz.enea.it/moda-ml/repository/codelist/draft/gc_NT72.xml</a><br>(XPath FASCatalog/FCbody/FCgroup/FCitem/picture/pictureUse) 0-1<br>(XPath FASCatalog/FCbody/FCgroup/picture/pictureUse) 0-1<br>(XPath FASCatalog/FCheader/picture/pictureUse) 0-1 |
| pieceInnWrap1    | code specifying the type of inner wrapping/packing used for the fabric piece<br>- base type: string, cod. table: T4<br><a href="http://www.ebiz.enea.it/moda-ml/repository/codelist/draft/gc_T4.xml">http://www.ebiz.enea.it/moda-ml/repository/codelist/draft/gc_T4.xml</a><br>(XPath FASCatalog/FCbody/FCgroup/FCitem/packages/handlingChar/piecePack/pieceInnWrap1) 1-1                                   |
| pieceInnWrap2    | code sub-specifying the type of inner wrapping/packing used for the fabric piece<br>- base type: string, cod. table: T5<br><a href="http://www.ebiz.enea.it/moda-ml/repository/codelist/draft/gc_T5.xml">http://www.ebiz.enea.it/moda-ml/repository/codelist/draft/gc_T5.xml</a><br>(XPath FASCatalog/FCbody/FCgroup/FCitem/packages/handlingChar/piecePack/pieceInnWrap2) 0-1                               |
| pieceOutWrap     | code specifying the type of outer wrapping or packing used for the fabric piece<br>- base type: string, cod. table: T6<br><a href="http://www.ebiz.enea.it/moda-ml/repository/codelist/draft/gc_T6.xml">http://www.ebiz.enea.it/moda-ml/repository/codelist/draft/gc_T6.xml</a><br>(XPath FASCatalog/FCbody/FCgroup/FCitem/packages/handlingChar/piecePack/pieceOutWrap) 0-1                                 |
| piecePackText    | free text specifying the type of wrapping or packing used for the fabric piece<br>- base type: string, max length: 250,<br>(XPath FASCatalog/FCbody/FCgroup/FCitem/packages/handlingChar/piecePack/piecePackText) 1-1  |

|              |   |
|--------------|---|
| postCode     | code defining the postal zone<br>- base type: string, max length: 10,<br>(XPath FASCatalog/FCheader/supplier/postCode) 0-1<br>(XPath FASCatalog/FCheader/buyer/postCode) 0-1<br>(XPath FASCatalog/FCheader/thirdParty/postCode) 0-1   |
| prodServName | description of the product or service that either complements or substitutes its coding<br>- base type: string, max length: 100,<br>(XPath FASCatalog/FCbody/FCgroup/FCitem/prodServName) 0-1   |
| productLine  | the product line name of a fashion product.<br>- base type: string,<br>(XPath FASCatalog/FCbody/FCgroup/FCitem/garComInfo/productLine) 0-1<br>(XPath FASCatalog/garComInfo/productLine) 0-1<br>(XPath FASCatalog/FCbody/FCgroup/garComInfo/productLine) 0-1<br>(XPath FASCatalog/FCbody/FCgroup/FCitem/productLine) 0-1   |
| @progr       | progressive number in the sequence<br>- base type: positiveInteger, min inclusive: 1,<br>(XPath FASCatalog/terms/transInfo/@progr) [Optional]<br>- nota: <i>Indicates the position of the leg in a sequence of transport legs.</i><br>(XPath FASCatalog/FCbody/FCgroup/FCitem/packages/fillingCriterion/@progr) [Optional]                                      |
| project      | code used to assign the items ordered (fabric pieces, accessories, garments ...) to a specific project of the Client<br>- base type: string, max length: 40,<br>(XPath FASCatalog/FCbody/FCgroup/FCitem/garComInfo/project) 0-1<br>(XPath FASCatalog/garComInfo/project) 0-1<br>(XPath FASCatalog/FCbody/FCgroup/garComInfo/project) 0-1                        |
| qty          | net quantity of the article or object correlated, qualified by the function of the document (ordering, delivering, ..) and by the context<br>- base type: decimal, min inclusive: 0, fraction digits: 2,<br>(XPath FASCatalog/FCbody/FCgroup/FCitem/fashionProd/csRange/sizeMatrix/sizeRow/qty) 0-1   |
| qualityLevel | the product quality level (first choice, second choice,...).<br>- base type: string,<br>(XPath FASCatalog/FCbody/FCgroup/FCitem/fashionProd/csRange/sizeMatrix/sizeRow/itemsList/qualityLevel) 0-1  |
| @reelMat     | type of material of which a package for yarn is made<br>- base type: string, cod. table: T30<br><a href="http://www.ebiz.enea.it/moda-ml/repository/codelist/draft/gc_T30.xml">http://www.ebiz.enea.it/moda-ml/repository/codelist/draft/gc_T30.xml</a><br>(XPath FASCatalog/FCbody/FCgroup/FCitem/packages/handlingChar/yarnPack/yarnReel/@reelMat) [Optional] |
| @reelType    | type of package used for a yarn product<br>- base type: string, cod. table: T29<br><a href="http://www.ebiz.enea.it/moda-ml/repository/codelist/draft/gc_T29.xml">http://www.ebiz.enea.it/moda-ml/repository/codelist/draft/gc_T29.xml</a><br>(XPath FASCatalog/FCbody/FCgroup/FCitem/packages/handlingChar/yarnPack/yarnReel/@reelType) [Required]             |
| rendering    | rendering information about the image<br>- base type: string,<br>(XPath FASCatalog/FCbody/FCgroup/FCitem/picture/rendering) 0-1<br>(XPath FASCatalog/FCheader/picture/rendering) 0-1<br>(XPath FASCatalog/FCbody/FCgroup/picture/rendering) 0-1   |
| resolution   | measure of spatial density of the picture<br>- base type: string, max length: 255,<br>(XPath FASCatalog/FCheader/picture/resolution) 0-1<br>(XPath FASCatalog/FCbody/FCgroup/FCitem/picture/resolution) 0-1<br>(XPath FASCatalog/FCbody/FCgroup/picture/resolution) 0-1   |

|                 |  |
|-----------------|--|
| @resolutionType | <p>it indicates the type of density of the picture</p> <ul style="list-style-type: none"> <li>- base type: string, cod. table: NT71</li> <li><a href="http://www.ebiz.enea.it/moda-ml/repository/codelist/draft/gc_NT71.xml">http://www.ebiz.enea.it/moda-ml/repository/codelist/draft/gc_NT71.xml</a></li> <li>(XPath FASCatalog/FCbody/FCgroup/FCitem/picture/resolution/@resolutionType) [Optional] [Default= dpi]</li> <li>(XPath FASCatalog/FCbody/FCgroup/picture/resolution/@resolutionType) [Optional] [Default= dpi]</li> <li>(XPath FASCatalog/FCheader/picture/resolution/@resolutionType) [Optional] [Default= dpi]</li> </ul>   |
| @role           | <p>Third Party role qualifier</p> <ul style="list-style-type: none"> <li>- base type: string, cod. table: NT2</li> <li><a href="http://www.ebiz.enea.it/moda-ml/repository/codelist/draft/gc_NT2.xml">http://www.ebiz.enea.it/moda-ml/repository/codelist/draft/gc_NT2.xml</a></li> <li>(XPath FASCatalog/FCheader/thirdParty/@role) [Required]</li> </ul>   |
| season          | <p>sale season; defined as: season (1 crt) + year (4 crt) - season: S/S=1 A/W=2 Spring=3 Summer=4 Autumn=5 Winter=6: for more than four seasons use alphabetic sequence: 1st season=A 2nd season=B etc.etc.</p> <ul style="list-style-type: none"> <li>- base type: string, max length: 15,</li> <li>(XPath FASCatalog/FCbody/FCgroup/FCitem/garmentCategory/season) 0-1</li> <li>(XPath FASCatalog/FCbody/FCgroup/FCitem/garComInfo/season) 0-1</li> <li>- note: <i>Preferably do not use this element here if season is declared in the header.</i></li> <li>(XPath FASCatalog/FCbody/FCgroup/FCitem/refDoc/season) 0-1</li> <li>- note: <i>here indicates the season to which the referenced document belongs</i></li> <li>(XPath FASCatalog/FCheader/refDoc/season) 0-1</li> <li>- note: <i>here indicates the season to which the referenced document belongs</i></li> <li>(XPath FASCatalog/FCheader/season) 0-1</li> <li>(XPath FASCatalog/FCbody/FCgroup/garComInfo/season) 0-1</li> <li>- note: <i>Preferably do not use this element here if season is declared in the header.</i></li> <li>(XPath FASCatalog/garComInfo/season) 0-1</li> <li>- note: <i>Preferably do not use this element here if season is declared in the header.</i></li> <li>(XPath FASCatalog/FCbody/FCgroup/refDoc/season) 0-1</li> <li>- note: <i>here indicates the season to which the referenced document belongs</i></li> </ul> |
| @sender         | <p>qualifier that specifies the Party issuing of the document</p> <ul style="list-style-type: none"> <li>- base type: boolean,</li> <li>(XPath FASCatalog/FCheader/buyer/@sender) [Optional]</li> <li>- nota: <i>This attribute is mandatory when the STYLESHEET must be used</i></li> <li>(XPath FASCatalog/FCheader/supplier/@sender) [Optional]</li> <li>- nota: <i>This attribute is mandatory when the STYLESHEET must be used</i></li> <li>(XPath FASCatalog/FCheader/thirdParty/@sender) [Optional]</li> <li>- nota: <i>This attribute is mandatory when the STYLESHEET must be used</i></li> </ul>   |
| serialN         | <p>serial number used for the identification of a physical unit</p> <ul style="list-style-type: none"> <li>- base type: string, max length: 250,</li> <li>(XPath FASCatalog/FCbody/FCgroup/FCitem/fashionProd/csRange/sizeMatrix/sizeRow/itemsList/itemIdentification/serialN) 1-9</li> </ul> <hr/> <p><b>AAAA-WARNING! - text not AVAILABLE n. 245 - In=en</b></p> <ul style="list-style-type: none"> <li>- note: <i>multiple values of serialN are allowed for different representations of the serial identifier of the same product unit. Instances of serialN must differ at least for one value of numberingOrg and idQualifier.</i></li> </ul>  |
| size            | <p>size number of a fashion product (knitwear, clothing, ..)</p> <ul style="list-style-type: none"> <li>- base type: string, max length: 15,</li> <li>(XPath FASCatalog/FCbody/FCgroup/FCitem/fashionProd/garmentCode/garmentCodeB/size) 0-1</li> <li>(XPath FASCatalog/FCbody/FCgroup/FCitem/fashionProd/garmentPartCode/size) 0-1</li> <li>(XPath FASCatalog/FCbody/FCgroup/FCitem/fashionProd/csRange/sizeMatrix/sizeRow/size) 1-1</li> </ul>   |
| @sizeSystemBase | <p>base of the size system</p> <ul style="list-style-type: none"> <li>- base type: string, cod. table: T423</li> <li><a href="http://www.ebiz.enea.it/moda-ml/repository/codelist/draft/gc_T423.xml">http://www.ebiz.enea.it/moda-ml/repository/codelist/draft/gc_T423.xml</a></li> </ul>  |



|                   |  |
|-------------------|--|
|                   | (XPath FASCatalog/FCbody/FCgroup/FCitem/fashionProd/csRange/@sizeSystemBase) [Optional]  |
| @sizeSystemID     | the identifier of the size system.<br>- base type: string,<br>(XPath FASCatalog/FCbody/FCgroup/FCitem/fashionProd/csRange/@sizeSystemID) [Optional]  |
| @sizeSystemNat    | nation or agency identifying the size system<br>- base type: string, cod. table: T421<br><a href="http://www.ebiz.enea.it/moda-ml/repository/codelist/draft/gc_T421.xml">http://www.ebiz.enea.it/moda-ml/repository/codelist/draft/gc_T421.xml</a><br>(XPath FASCatalog/FCbody/FCgroup/FCitem/fashionProd/csRange/@sizeSystemNat) [Optional]   |
| @sizeSystemSeg    | market segment identifying the size system<br>- base type: string, cod. table: T422<br><a href="http://www.ebiz.enea.it/moda-ml/repository/codelist/draft/gc_T422.xml">http://www.ebiz.enea.it/moda-ml/repository/codelist/draft/gc_T422.xml</a><br>(XPath FASCatalog/FCbody/FCgroup/FCitem/fashionProd/csRange/@sizeSystemSeg) [Optional]   |
| sortableIndicator | It states if the item can be automatically sorted.<br>- base type: boolean,<br>(XPath FASCatalog/FCbody/FCgroup/FCitem/packages/handlingChar/sortableIndicator) 0-1  |
| specDate          | date by which the referenced blanket order must receive full product specific ations (e.g.: colour), according to one of the patterns YYYY-MM-DD, YYYY-MM-DD:HH-MM or YYYY-WW.<br>- base type: string,<br>(XPath FASCatalog/FCbody/FCgroup/garComInfo/specDate) 0-1<br>(XPath FASCatalog/FCbody/FCgroup/FCitem/garComInfo/specDate) 0-1<br>(XPath FASCatalog/garComInfo/specDate) 0-1                |
| stackabilityLevel | This value indicates the level at which the item can be stacked.<br>- base type: integer,<br>(XPath FASCatalog/FCbody/FCgroup/FCitem/packages/handlingChar/stackabilityLevel) 0-1  |
| street            | street and building number identifying a location<br>- base type: string, max length: 80,<br>(XPath FASCatalog/FCheader/supplier/street) 0-1<br>(XPath FASCatalog/FCheader/buyer/street) 0-1<br>(XPath FASCatalog/FCheader/thirdParty/street) 0-1  |
| subClass          | a code indicating the category (macro-class, class or sub-class) of a commodity classification system the article belongs to.<br>- base type: string,<br>(XPath FASCatalog/FCbody/FCgroup/FCitem/garmentCategory/goodsClassification/subClass) 0-1   |
| subCountry        | short name or code of the sub-country entity<br>- base type: string, max length: 9,<br>(XPath FASCatalog/FCheader/supplier/subCountry) 0-1<br>(XPath FASCatalog/FCheader/buyer/subCountry) 0-1<br>(XPath FASCatalog/FCheader/thirdParty/subCountry) 0-1  |
| subDept           | name or code of a contact department within a Party<br>- base type: string, max length: 40,<br>(XPath FASCatalog/FCheader/supplier/subDept) 0-1<br>(XPath FASCatalog/FCheader/thirdParty/subDept) 0-1<br>(XPath FASCatalog/FCheader/buyer/subDept) 0-1   |
| taxCategory       | duty or tax or fee category<br>- base type: string, cod. table: T62<br><a href="http://www.ebiz.enea.it/moda-ml/repository/codelist/draft/gc_T62.xml">http://www.ebiz.enea.it/moda-ml/repository/codelist/draft/gc_T62.xml</a><br>(XPath FASCatalog/terms/allowanceCharge/dtScheme/taxCategory) 0-1<br>(XPath FASCatalog/FCbody/FCgroup/FCitem/marketPrice/allowanceCharge/dtScheme/taxCategory) 0-1 |

|                    |  |
|--------------------|--|
|                    | (XPath FASCatalog/FCbody/FCgroup/allowanceCharge/dtScheme/taxCategory) 0-1<br>(XPath FASCatalog/FCbody/FCgroup/FCitem/dtScheme/taxCategory) 0-1<br>(XPath FASCatalog/FCbody/FCgroup/FCitem/allowanceCharge/dtScheme/taxCategory) 0-1   |
| taxRate            | duty or tax or fee percent rate<br>- base type: string,<br>(XPath FASCatalog/FCbody/FCgroup/FCitem/marketPrice/allowanceCharge/dtScheme/taxRate) 0-1<br>(XPath FASCatalog/FCbody/FCgroup/FCitem/dtScheme/taxRate) 0-1<br>(XPath FASCatalog/FCbody/FCgroup/allowanceCharge/dtScheme/taxRate) 0-1<br>(XPath FASCatalog/FCbody/FCgroup/FCitem/allowanceCharge/dtScheme/taxRate) 0-1<br>(XPath FASCatalog/terms/allowanceCharge/dtScheme/taxRate) 0-1  |
| @taxType           | duty or tax or fee type<br>- base type: string, cod. table: T61<br><a href="http://www.ebiz.enea.it/moda-ml/repository/codelist/draft/gc_T61.xml">http://www.ebiz.enea.it/moda-ml/repository/codelist/draft/gc_T61.xml</a><br>(XPath FASCatalog/FCbody/FCgroup/allowanceCharge/dtScheme/@taxType) [Required]<br>(XPath FASCatalog/FCbody/FCgroup/FCitem/allowanceCharge/dtScheme/@taxType) [Required]<br>(XPath FASCatalog/terms/allowanceCharge/dtScheme/@taxType) [Required]<br>(XPath FASCatalog/FCbody/FCgroup/FCitem/dtScheme/@taxType) [Required]<br>(XPath FASCatalog/FCbody/FCgroup/FCitem/marketPrice/allowanceCharge/dtScheme/@taxType) [Required] |
| @TID               | serial number wired into the RFID chip<br>- base type: string,<br>(XPath FASCatalog/FCbody/FCgroup/FCitem/packages/EPCList/EPC/@TID) [Optional]  |
| title              | document title<br>- base type: string,<br>(XPath FASCatalog/FCheader/picture/title) 0-unbounded<br>- note: Only one instance of this element for each different value of 'ln' attribute (language)<br>(XPath FASCatalog/FCbody/FCgroup/picture/title) 0-unbounded<br>- note: Only one instance of this element for each different value of 'ln' attribute (language)<br>(XPath FASCatalog/FCbody/FCgroup/FCitem/picture/title) 0-unbounded<br>- note: Only one instance of this element for each different value of 'ln' attribute (language)  |
| transCondition     | special condition of transport or special service requested to the Forwarder<br>- base type: string, cod. table: T38<br><a href="http://www.ebiz.enea.it/moda-ml/repository/codelist/draft/gc_T38.xml">http://www.ebiz.enea.it/moda-ml/repository/codelist/draft/gc_T38.xml</a><br>(XPath FASCatalog/terms/transInfo/transCondition) 0-3   |
| transConditionText | free text description of the special condition of transport or special service requested to the Forwarder<br>- base type: string, max length: 250,<br>(XPath FASCatalog/terms/transInfo/transConditionText) 0-1  |
| transMeans         | means of transport, in general or referred to a specific leg<br>- base type: string, cod. table: T40<br><a href="http://www.ebiz.enea.it/moda-ml/repository/codelist/draft/gc_T40.xml">http://www.ebiz.enea.it/moda-ml/repository/codelist/draft/gc_T40.xml</a><br>(XPath FASCatalog/terms/transInfo/transMeans) 0-1   |
| transMode          | way of transport, in general or referred to the specified leg<br>- base type: string, cod. table: T8<br><a href="http://www.ebiz.enea.it/moda-ml/repository/codelist/draft/gc_T8.xml">http://www.ebiz.enea.it/moda-ml/repository/codelist/draft/gc_T8.xml</a><br>(XPath FASCatalog/terms/transInfo/transMode) 1-1  |
| @transReason       | reason for the transport<br>- base type: string, cod. table: NT11<br><a href="http://www.ebiz.enea.it/moda-ml/repository/codelist/draft/gc_NT11.xml">http://www.ebiz.enea.it/moda-ml/repository/codelist/draft/gc_NT11.xml</a><br>(XPath FASCatalog/terms/transInfo/@transReason) [Optional]   |



|                      |   |
|----------------------|---|
| <b>@uid</b>          | <p>unique element identifier within the xml document</p> <p>- base type: string,</p> <p>(XPath FASCatalog/FCbody/FCgroup/refDoc/attachment/@uid) [Optional]</p> <p>(XPath FASCatalog/FCheader/picture/attachment/@uid) [Optional]</p> <p>(XPath FASCatalog/FCbody/FCgroup/picture/attachment/@uid) [Optional]</p> <p>(XPath FASCatalog/FCbody/FCgroup/FCitem/picture/attachment/@uid) [Optional]</p> <p>(XPath FASCatalog/FCbody/FCgroup/FCitem/refDoc/attachment/@uid) [Optional]</p> <p>(XPath FASCatalog/FCheader/refDoc/attachment/@uid) [Optional]</p>   |
| <b>@um</b>           | <p>specification of the unit of measure</p> <p>- base type: string, cod. table: NT7</p> <p><a href="http://www.ebiz.enea.it/moda-ml/repository/codelist/draft/gc_NT7.xml">http://www.ebiz.enea.it/moda-ml/repository/codelist/draft/gc_NT7.xml</a></p> <p>(XPath FASCatalog/FCheader/picture/height/@um) [Required]</p> <p>(XPath FASCatalog/FCbody/FCgroup/FCitem/picture/nominalWidth/@um) [Optional]</p> <p>(XPath FASCatalog/FCheader/picture/width/@um) [Required]</p> <p>(XPath FASCatalog/FCbody/FCgroup/FCitem/picture/nominalHeight/@um) [Optional]</p> <p>(XPath FASCatalog/FCbody/FCgroup/picture/height/@um) [Required]</p> <p>(XPath FASCatalog/FCbody/FCgroup/FCitem/picture/height/@um) [Required]</p> <p>(XPath FASCatalog/terms/transInfo/netWeight/@um) [Required]</p> <p>(XPath FASCatalog/terms/allowanceCharge/@um) [Optional]</p> <p>(XPath FASCatalog/FCbody/FCgroup/FCitem/fashionProd/csRange/sizeMatrix/sizeRow/qty/@um) [Required]</p> <p>(XPath FASCatalog/FCbody/FCgroup/picture/width/@um) [Required]</p> <p>(XPath FASCatalog/FCbody/FCgroup/FCitem/picture/width/@um) [Required]</p> <p>(XPath FASCatalog/terms/transInfo/grossWeight/@um) [Required]</p> <p>(XPath FASCatalog/FCbody/FCgroup/FCitem/packages/packageDim/height/@um) [Required]</p> <p>(XPath FASCatalog/FCbody/FCgroup/FCitem/packages/packageDim/width/@um) [Required]</p> <p>(XPath FASCatalog/FCbody/FCgroup/FCitem/packages/handlingChar/yarnPack/yarnReel/yarnReelID/@um) [Required]</p> <p>(XPath FASCatalog/FCbody/FCgroup/FCitem/marketPrice/catalogPrice/@um) [Required]</p> <p>(XPath FASCatalog/FCbody/FCgroup/FCitem/productDim/height/@um) [Required]</p> <p>(XPath FASCatalog/FCbody/FCgroup/FCitem/productDim/width/@um) [Required]</p> <p>(XPath FASCatalog/FCbody/FCgroup/FCitem/marketPrice/allowanceCharge/@um) [Optional]</p> <p>(XPath FASCatalog/FCbody/FCgroup/FCitem/packages/packageDim/length/@um) [Required]</p> <p>(XPath FASCatalog/FCbody/FCgroup/FCitem/packages/handlingChar/netWeight/@um) [Required]</p> <p>(XPath FASCatalog/FCbody/FCgroup/FCitem/packages/handlingChar/grossWeight/@um) [Required]</p> <p>(XPath FASCatalog/FCbody/FCgroup/allowanceCharge/@um) [Optional]</p> <p>(XPath FASCatalog/FCbody/FCgroup/FCitem/packages/handlingChar/volume/@um) [Required]</p> <p>(XPath FASCatalog/FCbody/FCgroup/FCitem/packages/handlingChar/yarnPack/yarnReel/yarnReelQty/@um) [Required]</p> <p>(XPath FASCatalog/FCbody/FCgroup/FCitem/packages/handlingChar/yarnPack/yarnReel/yarnReelH/@um) [Required]</p> <p>(XPath FASCatalog/FCbody/FCgroup/FCitem/packages/itemsPerPackage/@um) [Required]</p> <p>(XPath FASCatalog/FCbody/FCgroup/FCitem/packages/minItemsPerPackage/@um) [Required]</p> <p>(XPath FASCatalog/FCheader/picture/nominalHeight/@um) [Optional]</p> <p>(XPath FASCatalog/FCbody/FCgroup/FCitem/productDim/length/@um) [Required]</p> <p>(XPath FASCatalog/FCbody/FCgroup/picture/nominalHeight/@um) [Optional]</p> <p>(XPath FASCatalog/FCheader/picture/nominalWidth/@um) [Optional]</p> <p>(XPath FASCatalog/FCbody/FCgroup/FCitem/allowanceCharge/@um) [Optional]</p> <p>(XPath FASCatalog/FCbody/FCgroup/picture/nominalWidth/@um) [Optional]</p> |
| <b>unitOfMeasure</b> | <p>unit of measure.</p> <p>- base type: string, cod. table: NT7</p> <p><a href="http://www.ebiz.enea.it/moda-ml/repository/codelist/draft/gc_NT7.xml">http://www.ebiz.enea.it/moda-ml/repository/codelist/draft/gc_NT7.xml</a></p> <p>(XPath FASCatalog/FCbody/FCgroup/FCitem/unitOfMeasure) 0-99</p>   |

|                     |  |
|---------------------|--|
|                     | - note: <i>Unit of measurement in which the article is expressed. It is possible to indicate more than one distinguishing them with the measureQualifier attribute</i>   |
| unitOfSourceMeasure | unit of measure.<br>- base type: string, cod. table: NT7<br><a href="http://www.ebiz.enea.it/moda-ml/repository/codelist/draft/gc_NT7.xml">http://www.ebiz.enea.it/moda-ml/repository/codelist/draft/gc_NT7.xml</a><br>(XPath FASCatalog/FCbody/FCgroup/FCitem/measureConversion/unitOfSourceMeasure) 1-1  |
| unitOfTargetMeasure | unit of measure.<br>- base type: string, cod. table: NT7<br><a href="http://www.ebiz.enea.it/moda-ml/repository/codelist/draft/gc_NT7.xml">http://www.ebiz.enea.it/moda-ml/repository/codelist/draft/gc_NT7.xml</a><br>(XPath FASCatalog/FCbody/FCgroup/FCitem/measureConversion/unitOfTargetMeasure) 1-1  |
| uri                 | Uniform Resource Identifier (URI) that identifies the external object as an Internet resource<br>- base type: normalizedString,<br>(XPath FASCatalog/FCheader/picture/attachment/externalReference/uri) 1-1<br>(XPath FASCatalog/FCbody/FCgroup/refDoc/attachment/externalReference/uri) 1-1<br>(XPath FASCatalog/FCbody/FCgroup/picture/attachment/externalReference/uri) 1-1<br>(XPath FASCatalog/FCheader/refDoc/attachment/externalReference/uri) 1-1<br>(XPath FASCatalog/FCbody/FCgroup/FCitem/picture/attachment/externalReference/uri) 1-1<br>(XPath FASCatalog/FCbody/FCgroup/FCitem/refDoc/attachment/externalReference/uri) 1-1 |
| @useProfile         | use profile to which the present document is compliant if it was agreed by the parties. It is suggested a URI with reference to the firms or the URL of the profile.<br>- base type: string,<br>(XPath FASCatalog/@useProfile) [Optional]  |
| validityEnd         | date by which the validity ends, according to one of the patterns YYYY-MM-DD, YYYY-MM-DD:HH-MM or YYYY-WW.<br>- base type: string,<br>(XPath FASCatalog/FCbody/FCgroup/FCitem/picture/validityEnd) 0-1<br>(XPath FASCatalog/FCheader/picture/validityEnd) 0-1<br>(XPath FASCatalog/FCbody/FCgroup/picture/validityEnd) 0-1<br>(XPath FASCatalog/FCheader/validityEnd) 0-1  |
| validityStart       | date by which the validity starts, according to one of the patterns YYYY-MM-DD, YYYY-MM-DD:HH-MM or YYYY-WW.<br>- base type: string,<br>(XPath FASCatalog/FCbody/FCgroup/picture/validityStart) 0-1<br>(XPath FASCatalog/FCbody/FCgroup/FCitem/picture/validityStart) 0-1<br>(XPath FASCatalog/FCheader/validityStart) 0-1<br>(XPath FASCatalog/FCheader/picture/validityStart) 0-1  |
| variantCode         | Code of variant used for fashion product.<br>- base type: string,<br>(XPath FASCatalog/FCbody/FCgroup/FCitem/fashionProduct/csRange/garmentVariant/variantCode) 1-1<br>(XPath FASCatalog/FCbody/FCgroup/FCitem/fashionProduct/garmentCode/garmentCodeB/garmentVariant/variantCode) 1-1   |
| variantType         | Type of variant used for fashion product (examples: 'treatment', 'washing type', 'size class',...)<br>- base type: string,<br>(XPath FASCatalog/FCbody/FCgroup/FCitem/fashionProduct/csRange/garmentVariant/variantType) 1-1   |

|                 |  |
|-----------------|--|
|                 | (XPath FASCatalog/FCbody/FCgroup/FCitem/fashionProd/garmentCode/garmentCodeB/garmentVariant/variantType) 1-1   |
| @VAT            | VAT rate or code (DEPRECATED, use dtScheme element)<br>- base type: string, cod. table: NT16<br><a href="http://www.ebiz.enea.it/moda-ml/repository/codelist/draft/gc_NT16.xml">http://www.ebiz.enea.it/moda-ml/repository/codelist/draft/gc_NT16.xml</a><br>(XPath FASCatalog/terms/allowanceCharge/@VAT) [Optional]<br>(XPath FASCatalog/FCbody/FCgroup/FCitem/allowanceCharge/@VAT) [Optional]<br>(XPath FASCatalog/FCbody/FCgroup/FCitem/lineN/@VAT) [Optional]<br>- nota: <i>Deprecated, prefer dtScheme when available.</i><br>(XPath FASCatalog/FCbody/FCgroup/allowanceCharge/@VAT) [Optional]<br>(XPath FASCatalog/FCbody/FCgroup/FCitem/marketPrice/allowanceCharge/@VAT) [Optional]<br>(XPath FASCatalog/FCheader/thirdParty/@VAT) [Optional] |
| @version        | Dictionary version from which the instance has been created<br>- base type: string, cod. table: NT100<br><a href="http://www.ebiz.enea.it/moda-ml/repository/codelist/draft/gc_NT100.xml">http://www.ebiz.enea.it/moda-ml/repository/codelist/draft/gc_NT100.xml</a><br>(XPath FASCatalog/@version) [Optional] [Default= draft]  |
| volume          | effective volume of a specified object<br>- base type: decimal, min inclusive: 0, fraction digits: 2,<br>(XPath FASCatalog/FCbody/FCgroup/FCitem/packages/handlingChar/volume) 0-1   |
| width           | effective width of a specified object<br>- base type: decimal, min inclusive: 0, fraction digits: 2,<br>(XPath FASCatalog/FCbody/FCgroup/picture/width) 0-1<br>- note: <i>the 'um' attribute of this element must be 'E37' (pixel)</i><br>(XPath FASCatalog/FCbody/FCgroup/FCitem/packages/packageDim/width) 0-1<br>(XPath FASCatalog/FCbody/FCgroup/FCitem/productDim/width) 0-1<br>(XPath FASCatalog/FCbody/FCgroup/FCitem/picture/width) 0-1<br>- note: <i>the 'um' attribute of this element must be 'E37' (pixel)</i><br>(XPath FASCatalog/FCheader/picture/width) 0-1<br>- note: <i>the 'um' attribute of this element must be 'E37' (pixel)</i>   |
| yarnConeAngle   | tapering angle of the cone on which a yarn is reeled<br>- base type: positiveInteger,<br>(XPath FASCatalog/FCbody/FCgroup/FCitem/packages/handlingChar/yarnPack/yarnReel/yarnConeAngle) 0-1  |
| yarnOutWrap     | code specifying the type of outer wrapping or packing of a yarn<br>- base type: string, cod. table: T33<br><a href="http://www.ebiz.enea.it/moda-ml/repository/codelist/draft/gc_T33.xml">http://www.ebiz.enea.it/moda-ml/repository/codelist/draft/gc_T33.xml</a><br>(XPath FASCatalog/FCbody/FCgroup/FCitem/packages/handlingChar/yarnPack/yarnOutWrap) 0-1  |
| yarnOutWrapText | free text specifying the type of outer wrapping or packing of a yarn<br>- base type: string, max length: 250,<br>(XPath FASCatalog/FCbody/FCgroup/FCitem/packages/handlingChar/yarnPack/yarnOutWrapText) 0-1   |
| yarnReelID      | diameter of the bobbin used for a yarn product<br>- base type: decimal, min inclusive: 0, fraction digits: 2,<br>(XPath FASCatalog/FCbody/FCgroup/FCitem/packages/handlingChar/yarnPack/yarnReel/yarnReelID) 0-1   |
| yarnReelH       | height of the bobbin used a yarn product<br>- base type: decimal, min inclusive: 0, fraction digits: 2,<br>(XPath FASCatalog/FCbody/FCgroup/FCitem/packages/handlingChar/yarnPack/yarnReel/yarnReelH) 0-1  |
| yarnReelQty     | quantity of yarn (by weight or length) wound upon a bobbin<br>- base type: decimal, min inclusive: 0, fraction digits: 2,<br>(XPath FASCatalog/FCbody/FCgroup/FCitem/packages/handlingChar/yarnPack/yarnReel/yarnReelQty) 0-2  |

|              |  |
|--------------|--|
| yarnReelWrap | type of wrapping in which a package of yarn is wrapped<br>- base type: string, cod. table: T32<br><a href="http://www.ebiz.enea.it/moda-ml/repository/codelist/draft/gc_T32.xml">http://www.ebiz.enea.it/moda-ml/repository/codelist/draft/gc_T32.xml</a><br>(XPath FASCatalog/FCbody/FCgroup/FCitem/packages/<br>handlingChar/yarnPack/yarnInWrap/yarnReelWrap) 1-1 |
|--------------|--|

## 2.3 Suggested best practices

### **FASCatalog/FCbody/FCgroup/FCitem/marketPrice/**

**geographicArea/geographicAreaText** (text identifying a geographic area)

using a code (geographicAreaCode) is preferable when the area coincides with a state

### **FASCatalog/FCbody/FCgroup/FCitem/fashionProd/**

**csRange/sizeMatrix/sizeRow/itemsList/itemIdentification/serialN** (serial number used for the identification of a physical unit)

in the case of garment with RFID for anti-counterfeiting, RFID EPCGlobal for logistics and NFC for the customer experience there should be three serial elements with pairs of attributes numberingOrg/idQualifier: "CL"/"RFID", "GS1"/"RFID", "CL"/"NFC".

## 2.4 Enumeration tables

List of enumeration tables used in the XML document. You can find the corresponding codes at:  
<http://www.ebiz-tcf.eu/moda-ml/imple/moda-ml-draft.asp?lingua=en&pag=6>

NT100 - eBIZ TCFUpstream version  
NT11 - transport causal  
NT16 - VAT rate or code  
NT2 - third party qualifier  
NT29 - format of a date  
NT3 - data format  
NT4 - end use  
NT43 - operational code qualifier  
NT51 - Filling Criterion for Package homogeneity  
NT6 - coding system owner/issuer  
NT7 - unit of measure  
NT71 - picture resolution type  
NT72 - picture final use type  
T1 - terms of payment  
T10 - ISO3166 - Country  
T11 - transport package type  
T19 - fibre type  
T2 - Modes of payment  
T21 - type of document  
T29 - type of yarn package  
T3 - terms of delivery  
T30 - support of yarn package - material  
T32 - yarn reel wrapping type  
T33 - yarn outer packing  
T38 - transport conditions  
T4 - fabric piece inner packing (wrapping) 1  
T40 - type of transport means  
T41 - type of Allowance or Charge  
T421 - size system: nationality  
T422 - size system: market segment  
T423 - size system: base  
T44 - additional code type  
T48 - garment part type  
T5 - fabric piece inner packing (wrapping) 2  
T6 - fabric piece outer packing  
T61 - duty or tax or fee type  
T62 - duty or tax or fee category  
T8 - Modes of Transport  
T9 - ISO4217 - Currency

## ACKNOWLEDGEMENT



This action is part of the eBIZ-4.0 project, which has received funding from the European Union's COSME Programme (2014 - 2020).

## DISCLAIMER

The content of this document represents the views of the authors only and is their sole responsibility; it cannot be considered to reflect the views of the European Commission and/or the Executive Agency for Small and Medium-sized Enterprises (EASME) or any other body of the European Union.

The European Commission and the Agency do not accept any responsibility for use that may be made of the information it contains.

# Annex A

Representative images of the principal complex elements' structure.

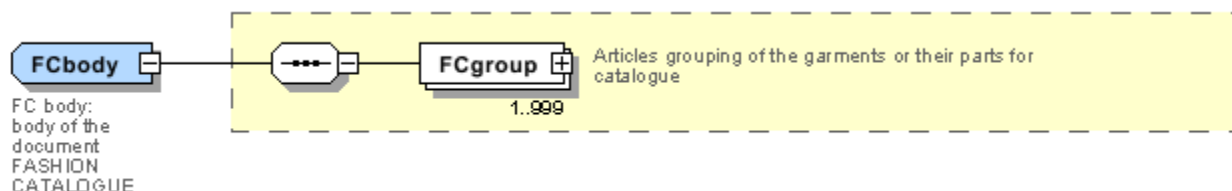
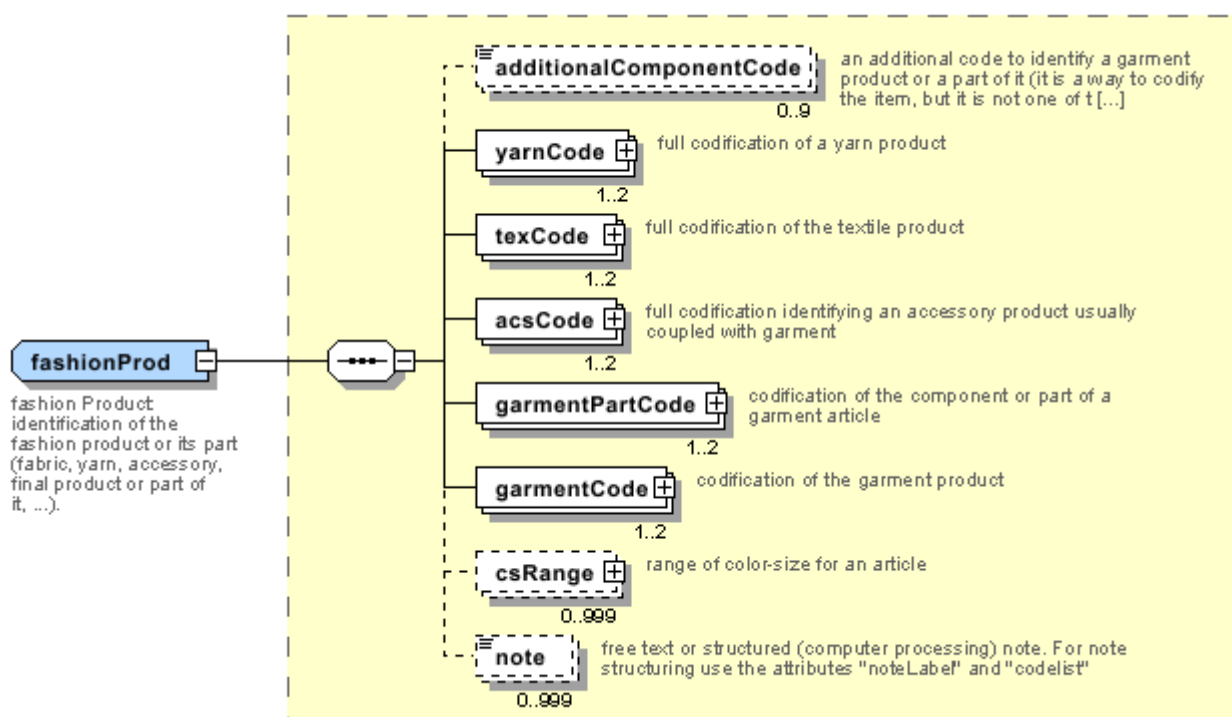
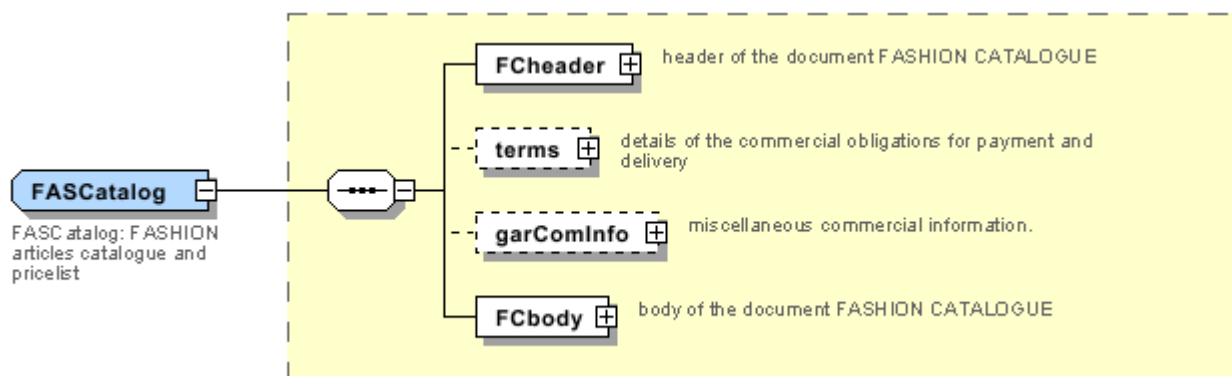



**FCgroup**  
 FC Group: Articles grouping of the garments or their parts for catalogue

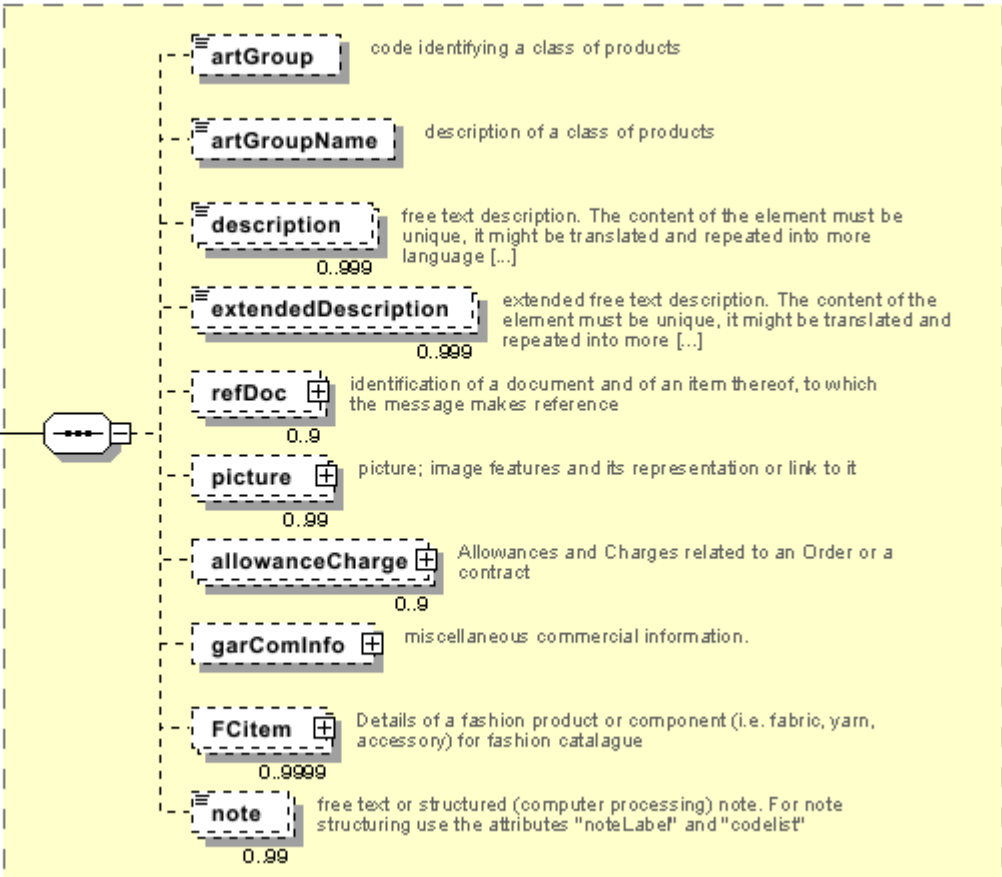

**FCheader**

FC header:  
header of the document  
FASHION  
CATALOGUE

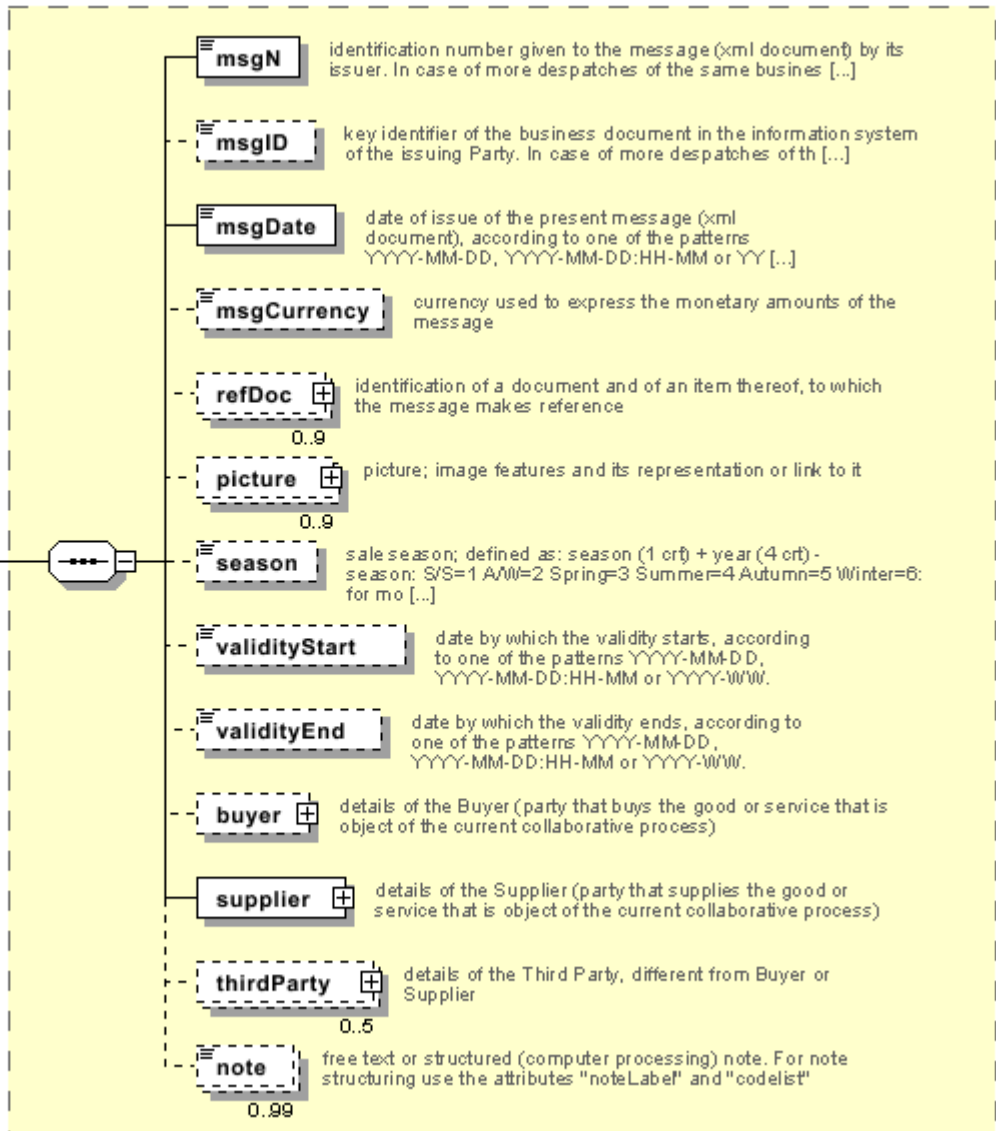

**FCItem**  
 FC Item: Details of a fashion product or component (i.e. fabric, yarn, accessory) for fashion catalogue

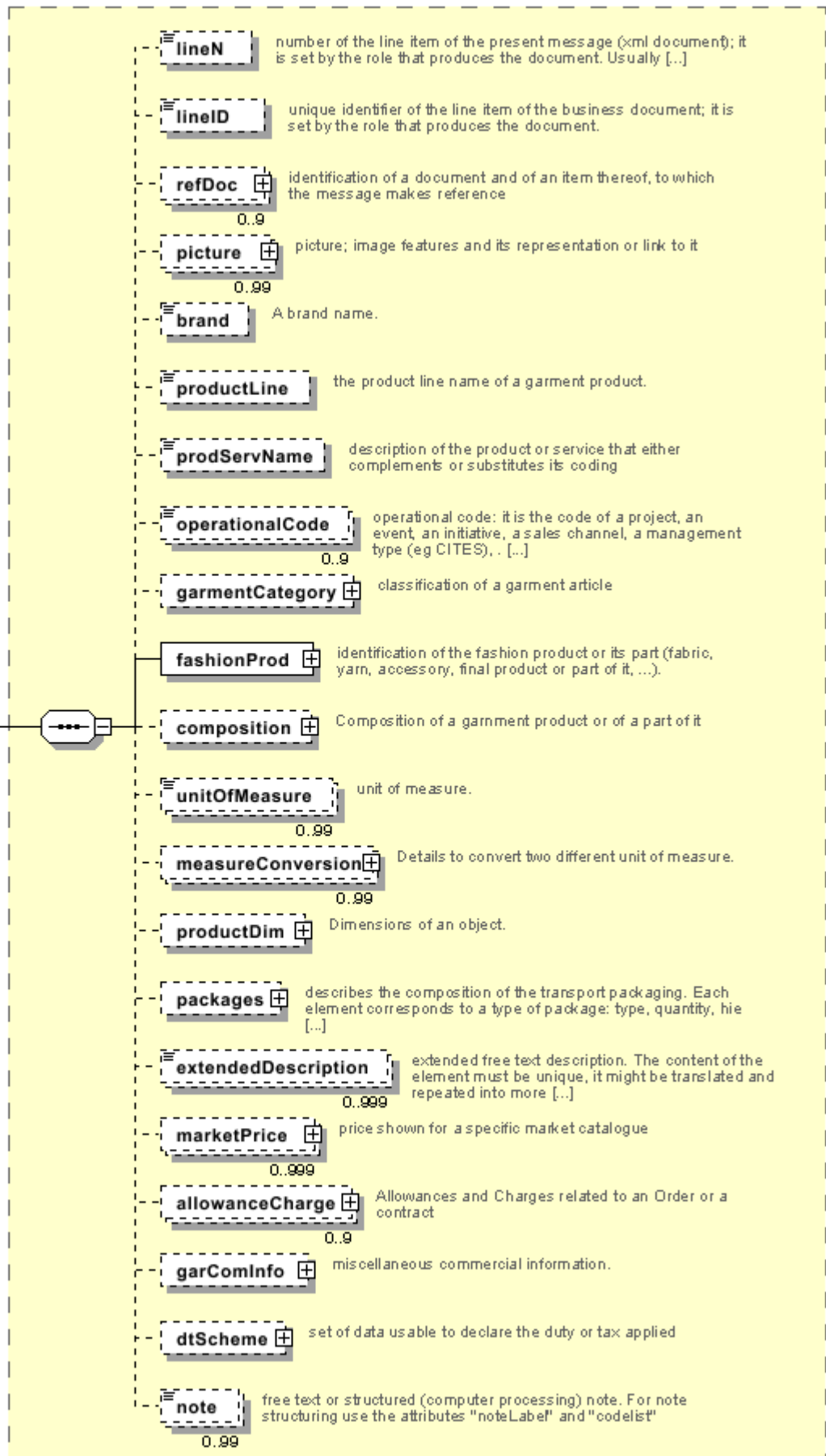

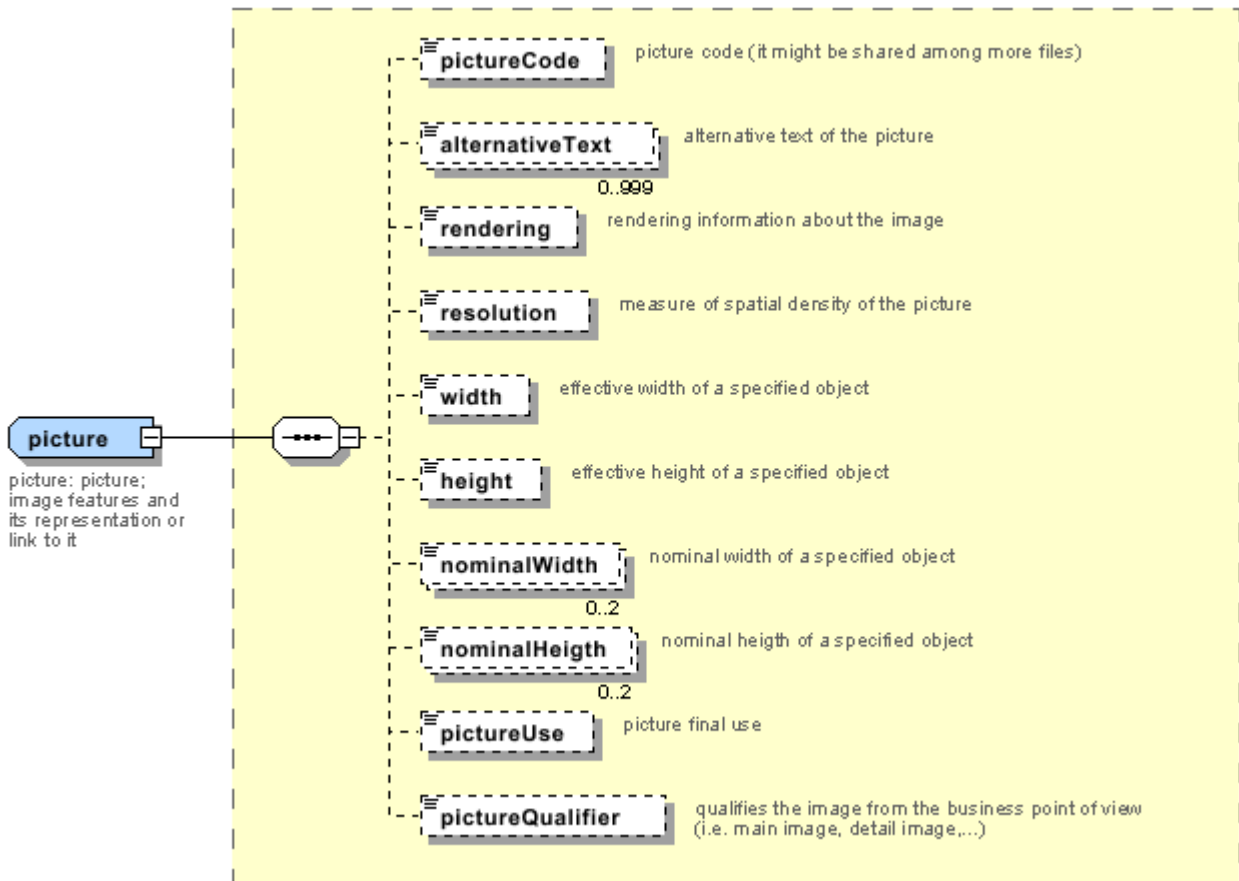
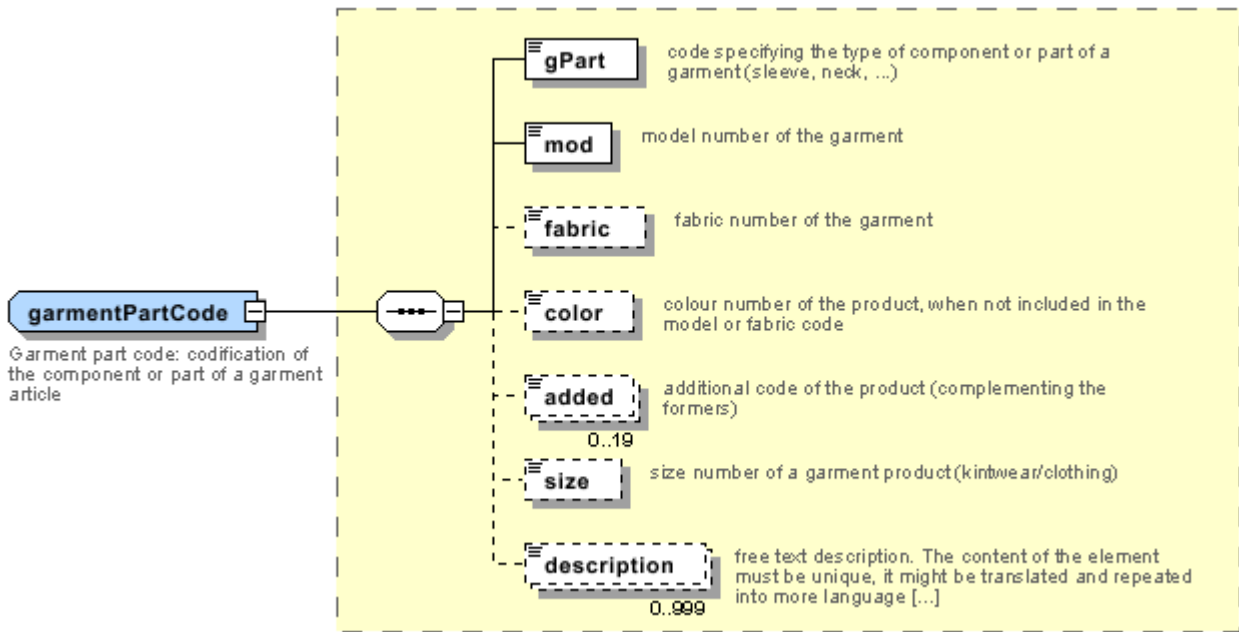

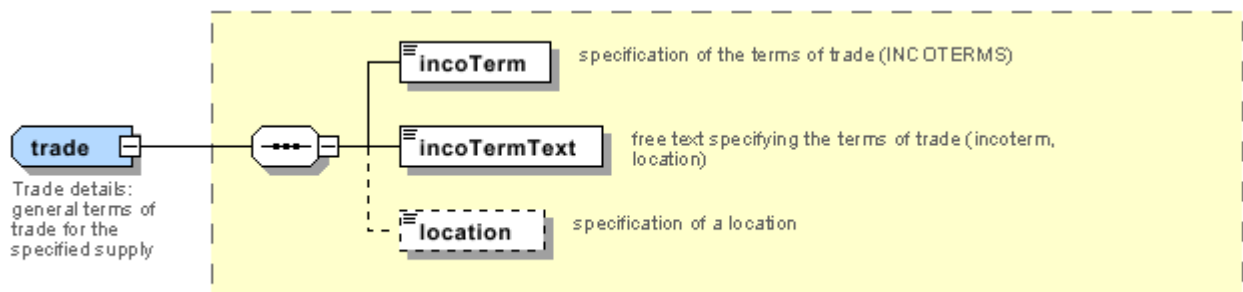
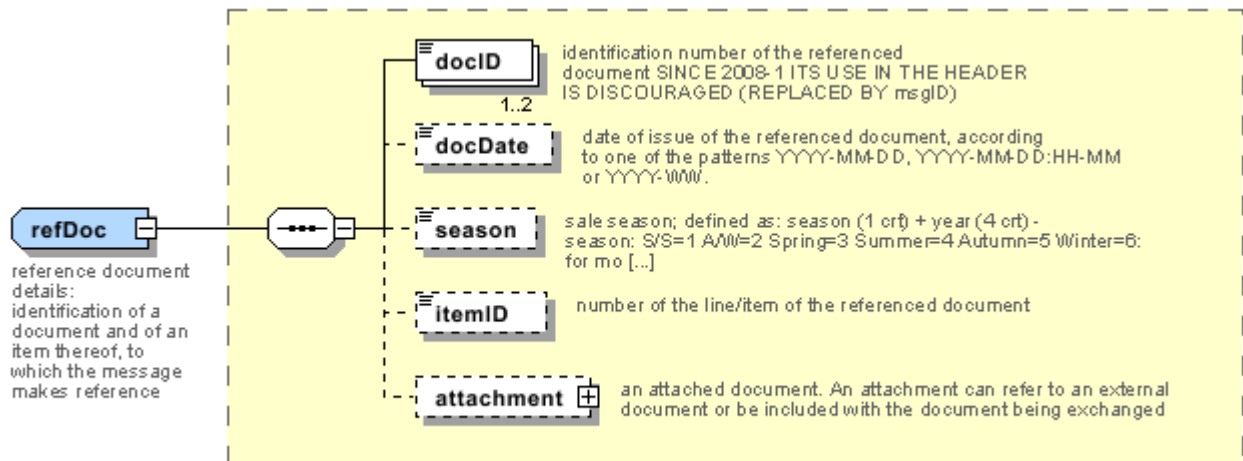
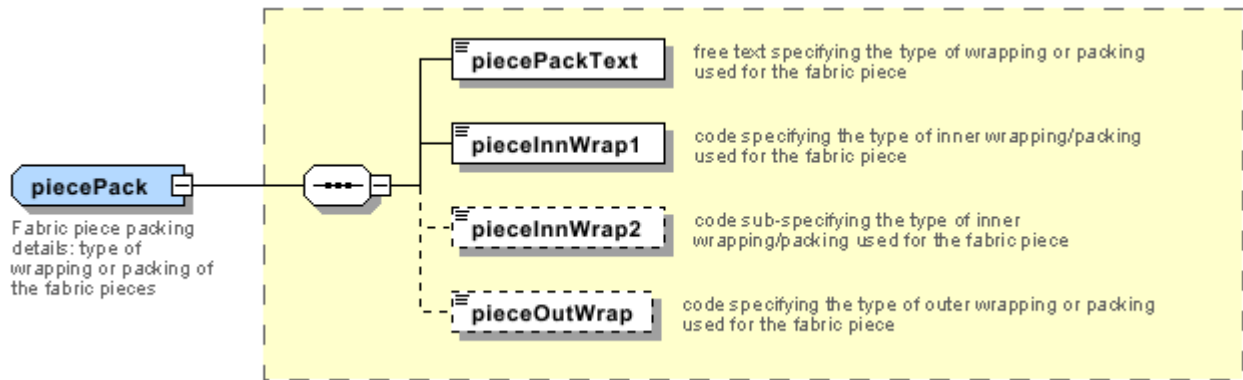



## Annex B

### NT100 - eBIZ TCFUpstream version

dictionary version

Agency name: eBIZ

tabella cod.: NT100

File codes list (Generic code): [http://www.ebiz.enea.it/moda-ml/repository/codelist/draft/gc\\_NT100.xml](http://www.ebiz.enea.it/moda-ml/repository/codelist/draft/gc_NT100.xml)

| Code   | Description | Adoption note | Date of insertion |
|--------|-------------|---------------|-------------------|
| 2013-1 | v2013-1     |               | 01/07/2013        |
| 2018-1 | v2018-1     |               | 04/11/2018        |
| draft  | draft       |               | 08/09/2017        |

### NT11 - transport causal

reason for the transport

Agency name: eBIZ

tabella cod.: NT11

File codes list (Generic code): [http://www.ebiz.enea.it/moda-ml/repository/codelist/draft/gc\\_NT11.xml](http://www.ebiz.enea.it/moda-ml/repository/codelist/draft/gc_NT11.xml)

| Code | Description           | Adoption note | Date of insertion |
|------|-----------------------|---------------|-------------------|
| FOC  | free of charge        |               |                   |
| FRW  | return from re-works  |               |                   |
| FST  | return from storage   |               |                   |
| FWW  | return from view      |               |                   |
| FWK  | return from works     |               |                   |
| IST  | in storage            |               |                   |
| NWK  | return non-worked     |               |                   |
| RJC  | return from rejection |               |                   |
| SEL  | to sell               |               |                   |
| STO  | to storage            |               |                   |
| VEW  | to view               |               |                   |
| WRK  | to works              |               |                   |

### NT16 - VAT rate or code

VAT rate or code ( DEPRECATED, use dtScheme element )

tabella cod.: NT16

File codes list (Generic code): [http://www.ebiz.enea.it/moda-ml/repository/codelist/draft/gc\\_NT16.xml](http://www.ebiz.enea.it/moda-ml/repository/codelist/draft/gc_NT16.xml)

### NT2 - third party qualifier

Third Party role qualifier

Agency name: eBIZ

tabella cod.: NT2

File codes list (Generic code): [http://www.ebiz.enea.it/moda-ml/repository/codelist/draft/gc\\_NT2.xml](http://www.ebiz.enea.it/moda-ml/repository/codelist/draft/gc_NT2.xml)

| Code | Description                          | Adoption note | Date of insertion |
|------|--------------------------------------|---------------|-------------------|
| AG   | Sales Agent                          |               |                   |
| CO   | Quality Controller                   |               |                   |
| DC   | Response to                          |               |                   |
| DF   | Invoicee                             |               |                   |
| DI   | Copy to (CC)                         |               | 28/10/2014        |
| DM   | Consignee                            |               |                   |
| DP   | Consignment address (Delivery Party) |               |                   |
| IM   | Importer                             |               |                   |
| OR   | Originator                           |               | 10/09/2014        |
| SP   | Forwarder                            |               |                   |
| TX   | Tax Representative                   |               |                   |

### NT29 - format of a date

format used for the date

Agency name: eBIZ

tabella cod.: NT29

File codes list (Generic code): [http://www.ebiz.enea.it/moda-ml/repository/codelist/draft/gc\\_NT29.xml](http://www.ebiz.enea.it/moda-ml/repository/codelist/draft/gc_NT29.xml)

| Code | Description      | Adoption note | Date of insertion |
|------|------------------|---------------|-------------------|
| D    | YYYY-MM-DD       |               |                   |
| M    | YYYY-MM-DD:HH-MM |               |                   |
| W    | YYYY-WW          |               |                   |



### NT3 - data format

format of a string according to a customized User rule (local rule)

Agency name: eBIZ

tabella cod.: NT3

File codes list (Generic code): [http://www.ebiz.enea.it/moda-ml/repository/codelist/draft/gc\\_NT3.xml](http://www.ebiz.enea.it/moda-ml/repository/codelist/draft/gc_NT3.xml)

| Code | Description     | Adoption note | Date of insertion |
|------|-----------------|---------------|-------------------|
| EN4  | GS1-GLN         |               | 01/07/2013        |
| MD   | mutually agreed |               |                   |

### NT4 - end use

specifies the final use of the product

Agency name: eBIZ

tabella cod.: NT4

File codes list (Generic code): [http://www.ebiz.enea.it/moda-ml/repository/codelist/draft/gc\\_NT4.xml](http://www.ebiz.enea.it/moda-ml/repository/codelist/draft/gc_NT4.xml)

| Code | Description  | Adoption note | Date of insertion |
|------|--------------|---------------|-------------------|
| PC   | test piece   |               |                   |
| PR   | production   |               |                   |
| SA   | Sample       |               | 10/09/2014        |
| SC   | samples card |               |                   |
| TI   | patch        |               |                   |
| TP   | (test cut)   |               |                   |

### NT43 - operational code qualifier

Agency name: eBIZ

tabella cod.: NT43

File codes list (Generic code): [http://www.ebiz.enea.it/moda-ml/repository/codelist/draft/gc\\_NT43.xml](http://www.ebiz.enea.it/moda-ml/repository/codelist/draft/gc_NT43.xml)

| Code | Description   | Adoption note | Date of insertion |
|------|---------------|---------------|-------------------|
| 1    | event         |               | 08/09/2017        |
| 2    | sales channel |               | 08/09/2017        |

|   |                       |  |            |
|---|-----------------------|--|------------|
| 3 | goods management type |  | 08/09/2017 |
| 4 | special initiative    |  | 08/09/2017 |

### NT51 - Filling Criterion for Package homogeneity

Filling Criterion for Package homogeneity

Agency name: eBIZ

tabella cod.: NT51

File codes list (Generic code): [http://www.ebiz.enea.it/moda-ml/repository/codelist/draft/gc\\_NT51.xml](http://www.ebiz.enea.it/moda-ml/repository/codelist/draft/gc_NT51.xml)

| Code | Description | Adoption note | Date of insertion |
|------|-------------|---------------|-------------------|
| COL  | Colour      |               | 08/09/2017        |
| MOD  | Model       |               | 08/09/2017        |
| SIZ  | Size        |               | 08/09/2017        |

### NT6 - coding system owner/issuer

code specifying the organisation who has created or owns the coding or numbering system

Agency name: eBIZ

tabella cod.: NT6

File codes list (Generic code): [http://www.ebiz.enea.it/moda-ml/repository/codelist/draft/gc\\_NT6.xml](http://www.ebiz.enea.it/moda-ml/repository/codelist/draft/gc_NT6.xml)

| Code | Description                  | Adoption note | Date of insertion |
|------|------------------------------|---------------|-------------------|
| CL   | Customer/buyer               |               |                   |
| CO   | Quality Controller           |               |                   |
| EN   | GS1 ( ex-EAN International ) |               |                   |
| ES   | e-Stockflow                  |               |                   |
| FO   | Supplier                     |               |                   |
| GS   | GS1                          |               | 01/07/2013        |
| MF   | VAT identifier               |               |                   |
| ML   | Moda-ML                      |               |                   |
| SP   | Service Provider             |               |                   |

### NT7 - unit of measure

specification of the unit of measure, it is a sub set of table Unit of Measure Code - UN/ECE REC 20 delivered by United Nations Economic Commission for Europe (UN/ECE)

Agency name: eBIZ / UN/ECE

tabella cod.: NT7

File codes list (Generic code): [http://www.ebiz.enea.it/moda-ml/repository/codelist/draft/gc\\_NT7.xml](http://www.ebiz.enea.it/moda-ml/repository/codelist/draft/gc_NT7.xml)

Other link: <http://docs.oasis-open.org/ubl/os-UBL-2.1/cl/gc/default/UnitOfMeasureCode-2.1.gc#>

| <b>Code</b> | <b>Description</b> | <b>Adoption note</b> | <b>Date of insertion</b> |
|-------------|--------------------|----------------------|--------------------------|
| CMK         | square centimetre  |                      | 20/12/2017               |
| CMQ         | cubic centimetre   |                      | 20/12/2017               |
| CMT         | centimetre         |                      |                          |
| CNE         | centiNewton        |                      |                          |
| CO2TON      | ton of CO2         |                      | 10/09/2014               |
| COUPLES     | couples            |                      |                          |
| DMQ         | cubic decimetre    |                      |                          |
| E37         | pixel              |                      | 11/04/2018               |
| GRM         | gram               |                      |                          |
| HUR         | hour               |                      |                          |
| INH         | inch               |                      |                          |
| KGM         | kilogram           |                      |                          |
| KMT         | kilometer          |                      |                          |
| KWH         | kilowatthours      |                      | 10/09/2014               |
| LBR         | pound              |                      |                          |
| MIN         | minute             |                      |                          |
| MMK         | centimetre         |                      | 20/12/2017               |
| MMK         | square millimetre  |                      | 20/12/2017               |
| MTK         | square metre       |                      | 20/12/2017               |
| MTQ         | cubic metre        |                      |                          |
| MTR         | metre              |                      |                          |
| NMB         | numero             |                      |                          |
| ONZ         | ounce              |                      |                          |
| P1          | percent            |                      |                          |
| PPM         | parts per milion   |                      |                          |
| PZ          | piece              |                      |                          |
| RPM         | rounds per metre   |                      |                          |
| YRD         | yard               |                      |                          |

### NT71 - picture resolution type

the type of density of the picture

Agency name: eBIZ

tabella cod.: NT71

File codes list (Generic code): [http://www.ebiz.enea.it/moda-ml/repository/codelist/draft/gc\\_NT71.xml](http://www.ebiz.enea.it/moda-ml/repository/codelist/draft/gc_NT71.xml)

| Code | Description     | Adoption note | Date of insertion |
|------|-----------------|---------------|-------------------|
| dpi  | dots per inch   |               | 11/04/2018        |
| ppi  | pixels per inch |               | 11/04/2018        |

### NT72 - picture final use type

the type of final use of the picture

Agency name: eBIZ

tabella cod.: NT72

File codes list (Generic code): [http://www.ebiz.enea.it/moda-ml/repository/codelist/draft/gc\\_NT72.xml](http://www.ebiz.enea.it/moda-ml/repository/codelist/draft/gc_NT72.xml)

| Code | Description           | Adoption note | Date of insertion |
|------|-----------------------|---------------|-------------------|
| ICO  | online icon           |               | 11/04/2018        |
| IMG  | generic online image  |               | 11/04/2018        |
| IML  | online image large    |               | 11/04/2018        |
| IMM  | online image medium   |               | 11/04/2018        |
| IMS  | online image small    |               | 11/04/2018        |
| PRH  | high quality printing |               | 11/04/2018        |
| PRN  | printing              |               | 11/04/2018        |

### T1 - terms of payment

code specifying the terms or time by which the payment must be done

Agency name: eBIZ

tabella cod.: T1

File codes list (Generic code): [http://www.ebiz.enea.it/moda-ml/repository/codelist/draft/gc\\_T1.xml](http://www.ebiz.enea.it/moda-ml/repository/codelist/draft/gc_T1.xml)

| Code | Description | Adoption note | Date of insertion |
|------|-------------|---------------|-------------------|
|------|-------------|---------------|-------------------|

|                |  |  |  |
|----------------|--|--|--|
| ANTICIP        | PAYMENT IN ADVANCE                             |  |  |
| BLCOLLECT/120D | BILL OF LADING 120 DD                          |  |  |
| BLCOLLECT/30D  | BILL OF LADING 30 DD                           |  |  |
| BLCOLLECT/60D  | BILL OF LADING 60 DD                           |  |  |
| BLCOLLECT/90D  | BILL OF LADING 90 DD                           |  |  |
| CASH           | PAYMENT ON DELIVERY                            |  |  |
| CASHINV        | PAYMENT ON RECEIPT OF INVOICE                  |  |  |
| CREDOC/0D      | DOCUMENTARY CREDIT FOR PAYM. AT SIGHT          |  |  |
| CREDOC/120     | DOCUMENTARY CREDIT FOR PAYM. AT 120 DD         |  |  |
| CREDOC/150     | DOCUMENTARY CREDIT FOR PAYM. AT 150 DD         |  |  |
| CREDOC/180     | DOCUMENTARY CREDIT FOR PAYM. AT 180 DD         |  |  |
| CREDOC/30D     | DOCUMENTARY CREDIT FOR PAYM. AT 30 DD          |  |  |
| CREDOC/45D     | DOCUMENTARY CREDIT FOR PAYM. AT 45 DD          |  |  |
| CREDOC/60      | DOCUMENTARY CREDIT FOR PAYM. AT 60 DD          |  |  |
| CREDOC/90      | DOCUMENTARY CREDIT FOR PAYM. AT 90 DD          |  |  |
| DEL/10         | PAYMENT AT 10 DD AFTER DELIVERY                |  |  |
| DOCOLLECT/120D | DOCUMENTARY COLLECTION AT 120 DD               |  |  |
| DOCOLLECT/30D  | DOCUMENTARY COLLECTION AT 30 DD                |  |  |
| DOCOLLECT/60D  | DOCUMENTARY COLLECTION AT 60 DD                |  |  |
| DOCOLLECT/90D  | DOCUMENTARY COLLECTION AT 90 DD                |  |  |
| INV/120D       | PAYMENT AT 120 DD AFTER RECEIPT OF INVOICE     |  |  |
| INV/150D       | PAYMENT AT 150 DD AFTER RECEIPT OF INVOICE     |  |  |
| INV/180D       | PAYMENT AT 180 DD AFTER RECEIPT OF INVOICE     |  |  |
| INV/30D        | PAYMENT AT 30 DD AFTER RECEIPT OF INVOICE      |  |  |
| INV/45D        | PAYMENT AT 45 DD AFTER RECEIPT OF INVOICE      |  |  |
| INV/60D        | PAYMENT AT 60 DD AFTER RECEIPT OF INVOICE      |  |  |
| INV/90D        | PAYMENT AT 90 DD AFTER RECEIPT OF INVOICE      |  |  |
| INVULTIMO      | PAYMENT AT END MONTH RECEIPT INVOICE           |  |  |
| INVULTIMO/10D  | PAYMENT 10 DD AFTER END MONTH RECEIPT INVOICE  |  |  |
| INVULTIMO/120D | PAYMENT 120 DD AFTER END MONTH RECEIPT INVOICE |  |  |
| INVULTIMO/150D | PAYMENT 150 DD AFTER END MONTH RECEIPT INVOICE |  |  |
| INVULTIMO/180D | PAYMENT 180 DD AFTER END MONTH RECEIPT INVOICE |  |  |
| INVULTIMO/240D | PAYMENT 240 DD AFTER END MONTH RECEIPT INVOICE |  |  |
| INVULTIMO/30D  | PAYMENT 30 DD AFTER END MONTH RECEIPT INVOICE  |  |  |
| INVULTIMO/45D  | PAYMENT 45 DD AFTER END MONTH RECEIPT INVOICE  |  |  |

|               |   |  |  |
|---------------|---|--|--|
| INVULTIMO/60D | PAYMENT 60 DD AFTER END MONTH RECEIPT INVOICE   |  |  |
| INVULTIMO/90D | PAYMENT 90 DD AFTER END MONTH RECEIPT INVOICE   |  |  |
| NOPAY         | WITHOUT PAYMENT                                 |  |  |
| RECREDOC/0D   | IRREVOC. DOCUMENTARY CREDIT FOR PAYM. AT SIGHT  |  |  |
| RECREDOC/120D | IRREVOC. DOCUMENTARY CREDIT FOR PAYM. AT 120 DD |  |  |
| RECREDOC/150D | IRREVOC. DOCUMENTARY CREDIT FOR PAYM. AT 150 DD |  |  |
| RECREDOC/180D | IRREVOC. DOCUMENTARY CREDIT FOR PAYM. AT 180 DD |  |  |
| RECREDOC/30D  | IRREVOC. DOCUMENTARY CREDIT FOR PAYM. AT 30 DD  |  |  |
| RECREDOC/45D  | IRREVOC. DOCUMENTARY CREDIT FOR PAYM. AT 45 DD  |  |  |
| RECREDOC/60D  | IRREVOC. DOCUMENTARY CREDIT FOR PAYM. AT 60 DD  |  |  |
| RECREDOC/90D  | IRREVOC. DOCUMENTARY CREDIT FOR PAYM. AT 90 DD  |  |  |
| ULTIMO        | PAYMENT BY END MONTH OF DELIVERY                |  |  |
| ULTIMO/10     | PAYMENT AT 10 DD AFTER END MONTH OF DELIVERY    |  |  |

### T10 - ISO3166 - Country

code of the nation

Agency name: ISO

tabella cod.: T10

File codes list (Generic code): [http://www.ebiz.enea.it/moda-ml/repository/codelist/draft/gc\\_T10.xml](http://www.ebiz.enea.it/moda-ml/repository/codelist/draft/gc_T10.xml)

Table not printed: there are 239 elements, more than the maximum specified for printing: 99.

### T11 - transport package type

code specifying the type of package used for transport and delivery (subset of UN/ECE 8053 and UBL TransportEquipmentTypeCode-2.1)

Agency name: eBIZ

tabella cod.: T11

File codes list (Generic code): [http://www.ebiz.enea.it/moda-ml/repository/codelist/draft/gc\\_T11.xml](http://www.ebiz.enea.it/moda-ml/repository/codelist/draft/gc_T11.xml)

Other link: <http://docs.oasis-open.org/ubl/os-UBL-2.1/cl/gc/default/TransportEquipmentTypeCode-2.1.gc#>

| Code | Description     | Adoption note | Date of insertion |
|------|-----------------|---------------|-------------------|
| 4A   | box, steel      |               |                   |
| 4C   | box, wood       |               |                   |
| 4G   | Box, fibreboard |               | 01/08/2018        |
| 4H   | Box, plastic    |               | 01/08/2018        |

|    |   |  |            |
|----|---|--|------------|
| 5H | Bag, woven plastic  |  | 01/08/2018 |
| 5L | Bag, textile  |  | 01/08/2018 |
| 5M | Bag, paper  |  |            |
| AJ | Cone  |  | 01/08/2018 |
| BL | Bale, compressed  |  | 01/08/2018 |
| BN | Bale, non-compressed                                      |  | 01/08/2018 |
| BX | Box   |  |            |
| CI | Canister  |  | 01/08/2018 |
| CL | Coil  |  | 01/08/2018 |
| CN | Container, not otherwise specified as transport equipment |  | 01/08/2018 |
| CS | Case  |  | 01/08/2018 |
| CT | Carton  |  | 01/08/2018 |
| EC | Bag, plastic  |  | 01/08/2018 |
| ED | Case, with pallet base                                    |  | 01/08/2018 |
| EE | Case, with pallet base, wooden                            |  | 01/08/2018 |
| EF | Case, with pallet base, cardboard                         |  | 01/08/2018 |
| EG | Case, with pallet base, plastic                           |  | 01/08/2018 |
| EH | Case, with pallet base, metal                             |  | 01/08/2018 |
| FX | Bag, flexible container                                   |  | 01/08/2018 |
| HN | Hanger  |  | 01/08/2018 |
| NE | unpacked  |  |            |
| NF | Unpacked or unpackageged, single unit                     |  | 01/08/2018 |
| NG | Unpacked or unpackageged, multiple units                  |  | 01/08/2018 |
| OA | Pallet, CHEP 40 cm x 60 cm                                |  | 01/08/2018 |
| OB | Pallet, CHEP 80 cm x 120 cm                               |  | 01/08/2018 |
| OC | Pallet, CHEP 100 cm x 120 cm                              |  | 01/08/2018 |
| OD | Pallet, AS 4068-1993                                      |  | 01/08/2018 |
| OE | Pallet, ISO T11   |  | 01/08/2018 |
| PE | europallet (80x120)                                       |  |            |
| PX | pallet  |  |            |
| QS | box, plastic, solid                                       |  |            |
| RJ | Rack, clothing hanger                                     |  | 01/08/2018 |
| RL | Reel  |  | 01/08/2018 |
| SO | Spool   |  | 01/08/2018 |
| TU | tube  |  |            |

|    |  |  |            |
|----|--|--|------------|
| XD | bag, plastics film                     |  |            |
| XK | bag,paper, multi-wall, water resistant |  |            |
| ZZ | Mutually defined                       |  | 01/08/2018 |

### T19 - fibre type

type of fibre used in a textile product

Agency name: eBIZ

tabella cod.: T19

File codes list (Generic code): [http://www.ebiz.enea.it/moda-ml/repository/codelist/draft/gc\\_T19.xml](http://www.ebiz.enea.it/moda-ml/repository/codelist/draft/gc_T19.xml)

| Code | Description        | Adoption note | Date of insertion |
|------|--------------------|---------------|-------------------|
| AB   | abaca              |               | 20/08/2018        |
| AC   | acetate            |               |                   |
| AF   | other fibres       |               |                   |
| AG   | alginic fibre      |               |                   |
| AL   | alfa               |               | 20/08/2018        |
| CA   | hemp               |               |                   |
| CC   | coir (coconut)     |               | 20/08/2018        |
| CL   | chlorofibre        |               |                   |
| CO   | cotton             |               |                   |
| CU   | cuprous            |               |                   |
| EA   | elastan            |               |                   |
| EL   | Elastodiene        |               | 20/08/2018        |
| FL   | fluorofibre        |               |                   |
| GI   | broom              |               | 20/08/2018        |
| GL   | textile glass      |               |                   |
| HA   | hair               |               | 20/08/2018        |
| HE   | henequen           |               | 20/08/2018        |
| HL   | mixed linen        |               |                   |
| HL   | cotton linen union |               | 20/08/2018        |
| JU   | jute               |               |                   |
| KE   | kenaf              |               | 20/08/2018        |
| KP   | kapoc              |               | 20/08/2018        |
| LI   | linen              |               |                   |
| LY   | lyocell            |               | 20/08/2018        |



|    |   |  |            |
|----|---|--|------------|
| MA | modacrylic                                  |  |            |
| MD | modal                                       |  |            |
| ME | metallized                                  |  |            |
| MG | maguey                                      |  | 20/08/2018 |
| PA | polyamide                                   |  |            |
| PB | polyureic                                   |  |            |
| PC | acrylic                                     |  |            |
| PE | polyethylene                                |  |            |
| PI | paper                                       |  | 20/08/2018 |
| PL | polyester                                   |  |            |
| PM | polyimide                                   |  |            |
| PP | polypropylene                               |  |            |
| PR | proteic                                     |  |            |
| PU | polyurethane                                |  |            |
| RA | mamie                                       |  | 20/08/2018 |
| SE | silk  |  |            |
| SI | sisal                                       |  | 20/08/2018 |
| SN | sun   |  | 20/08/2018 |
| TA | triacetate                                  |  |            |
| TR | textile residues or unspecified composition |  | 20/08/2018 |
| TV | trivinyll                                   |  |            |
| VI | viscose                                     |  |            |
| VY | vinylal                                     |  |            |
| WA | angora                                      |  |            |
| WB | beaver                                      |  | 20/08/2018 |
| WC | cashgora                                    |  |            |
| WG | vicuna                                      |  |            |
| WK | camel                                       |  |            |
| WL | llama                                       |  |            |
| WM | mohair                                      |  |            |
| WN | lapin                                       |  | 20/08/2018 |
| WO | wool  |  |            |
| WP | alpaca                                      |  |            |
| WS | cashmere                                    |  |            |
| WT | Oteer                                       |  | 20/08/2018 |

|    |             |  |  |
|----|-------------|--|--|
| WU | guanaco     |  |  |
| WV | virgin wool |  |  |
| WY | yack        |  |  |

## T2 - Modes of payment

way or means of payment

Agency name: eBIZ

tabella cod.: T2

File codes list (Generic code): [http://www.ebiz.enea.it/moda-ml/repository/codelist/draft/gc\\_T2.xml](http://www.ebiz.enea.it/moda-ml/repository/codelist/draft/gc_T2.xml)

| Code | Description                  | Adoption note | Date of insertion |
|------|------------------------------|---------------|-------------------|
| BB   | bank transfer                |               |                   |
| IA   | collection through Agent     |               |                   |
| IS   | collection through Forwarder |               |                   |
| RB   | bank receipt                 |               |                   |
| RD   | remittance                   |               |                   |
| SW   | bank SWIFT                   |               |                   |
| TR   | bank draft                   |               |                   |

## T21 - type of document

type or class to which the referenced document belongs

Agency name: eBIZ

tabella cod.: T21

File codes list (Generic code): [http://www.ebiz.enea.it/moda-ml/repository/codelist/draft/gc\\_T21.xml](http://www.ebiz.enea.it/moda-ml/repository/codelist/draft/gc_T21.xml)

| Code | Description                  | Adoption note | Date of insertion |
|------|------------------------------|---------------|-------------------|
| BOR  | blanket order                |               | 01/02/2018        |
| CAT  | Price catalogue - tech sheet |               |                   |
| CEO  | Certificate of origin        |               | 13/04/2018        |
| CER  | Certificate                  |               | 13/04/2018        |
| COC  | colour card                  |               |                   |
| CRN  | Credit note                  |               | 08/09/2017        |
| CTO  | Checking order               |               | 01/07/2013        |
| CTR  | Contract                     |               |                   |

|     |                                       |  |            |
|-----|---------------------------------------|--|------------|
| CXF | CxF3 file                             |  | 01/07/2013 |
| DAD | Darn order                            |  |            |
| DDT | ddt                                   |  |            |
| DEA | Despatch advise                       |  |            |
| DER | Despatch request                      |  |            |
| DR  | Document Request                      |  | 02/12/2014 |
| FOR | Forecast                              |  | 02/12/2014 |
| GSO | Garment stock offer                   |  |            |
| GSX | Garment stock offer change            |  |            |
| INV | Invoice                               |  |            |
| KCC | Knitting-Clothing Commission Order    |  | 02/12/2014 |
| KCI | Garment in Work Inventory Report      |  | 02/12/2014 |
| M2M | Made to Measure Production Order      |  | 02/12/2014 |
| MAS | Master marker                         |  |            |
| MCI | Visual merchandising instruction      |  | 13/04/2018 |
| OCH | Order change                          |  |            |
| OFF | Offer                                 |  |            |
| ORD | Purchase order                        |  |            |
| ORP | Order response                        |  |            |
| OSR | order status request                  |  |            |
| OSS | Offer status                          |  | 02/12/2014 |
| OST | Order status                          |  |            |
| OUR | our reference                         |  |            |
| QR  | Quality Report                        |  | 02/12/2014 |
| RAI | Raw Material in Work Inventory Report |  | 02/12/2014 |
| RDC | Raw dyeing commission order           |  |            |
| RDH | Raw dyeing order change               |  |            |
| RDR | Raw dyeing order response             |  |            |
| REA | Receiving advise                      |  |            |
| REQ | Request for Offer                     |  |            |
| RET | Return                                |  | 02/12/2014 |
| RSC | Spinning commission order             |  |            |
| RSH | Spinning order change                 |  |            |
| RSR | Spinning order response               |  |            |
| SCL | process sheet                         |  |            |

|     |   |  |            |
|-----|---|--|------------|
| TFC | Textile dyeing-finishing commission order |  |            |
| TFX | Textile Dyeing-Finishing Order Change     |  | 02/12/2014 |
| TPC | Textile printing commission order         |  |            |
| TPX | Textile Printing Order Change             |  | 02/12/2014 |
| TWI | Textile in work inventory                 |  |            |
| VMI | visual merchandising instructions         |  | 01/02/2018 |
| WAC | Warping commission order                  |  |            |
| WEC | Weaving commission order                  |  |            |
| YDC | Yarn dyeing commission order              |  |            |
| YDH | Yarn dyeing order change                  |  |            |
| YDR | Yarn dyeing order response                |  |            |
| YTC | Twisting commission order                 |  |            |
| YWI | Yarn in work inventory                    |  |            |

### T29 - type of yarn package

type of package (roll-up) used for a yarn product

Agency name: eBIZ

tabella cod.: T29

File codes list (Generic code): [http://www.ebiz.enea.it/moda-ml/repository/codelist/draft/gc\\_T29.xml](http://www.ebiz.enea.it/moda-ml/repository/codelist/draft/gc_T29.xml)

| Code | Description | Adoption note | Date of insertion |
|------|-------------|---------------|-------------------|
| CIL  | bobbin      |               |                   |
| CON  | cone        |               |                   |
| HNK  | hank, skein |               | 01/07/2013        |
| MUF  | muff, cake  |               | 01/07/2013        |
| SPL  | spool       |               |                   |
| TUB  | tube        |               |                   |
| XCO  | supercone   |               |                   |

### T3 - terms of delivery

specification of the terms of trade (INCOTERMS)

Agency name: Incoterms

tabella cod.: T3

File codes list (Generic code): [http://www.ebiz.enea.it/moda-ml/repository/codelist/draft/gc\\_T3.xml](http://www.ebiz.enea.it/moda-ml/repository/codelist/draft/gc_T3.xml)

| Code | Description  | Adoption note  | Date of insertion |
|------|--|--|-------------------|
| CFR  | COST AND FREIGHT (named port of destination)                   |  |                   |
| CIF  | COST, INSURANCE AND FREIGHT (named port of destination)        |  |                   |
| CIP  | CARRIAGE AND INSURANCE PAID (named place of destination)       |  |                   |
| CP T | CARRIAGE PAID (named place of destination)                     |  |                   |
| DAF  | DELIVERED AT FRONTIER (named place)                            | according to Incoterms® 2010 it is obsolete          | 08/12/2017        |
| DAP  | Delivered at Place of destination (named place of destination) | according to Incoterms® 2010                         | 08/12/2017        |
| DAT  | Delivered at Terminal (named place of destination)             | according to Incoterms® 2010                         | 08/12/2017        |
| DDP  | DELIVERED DUTY PAID (named place of destination)               |  |                   |
| DDU  | DELIVERED DUTY UNPAID (named place of destination)             | according to Incoterms® 2010 it is obsolete, use DAP | 08/12/2017        |
| DEQ  | DELIVERED EX-QUAY (named port of destination)                  | according to Incoterms® 2010 it is obsolete          | 08/12/2017        |
| DES  | DELIVERED EX-SHIP (named port of destination)                  | according to Incoterms® 2010 it is obsolete          | 08/12/2017        |
| EXW  | EX WORKS (named place)   |  |                   |
| FAS  | FREE ALONGSIDE SHIP (named port of shipment)                   |  |                   |
| FC A | FREE CARRIER (named place)                                     |  |                   |
| FOB  | FREE ON BOARD (named port of shipment)                         |  |                   |

### T30 - support of yarn package - material

type of material of which a package for yarn is made

Agency name: eBIZ

tabella cod.: T30

File codes list (Generic code): [http://www.ebiz.enea.it/moda-ml/repository/codelist/draft/gc\\_T30.xml](http://www.ebiz.enea.it/moda-ml/repository/codelist/draft/gc_T30.xml)

| Code | Description             | Adoption note | Date of insertion |
|------|-------------------------|---------------|-------------------|
| CA   | cartoon                 |               |                   |
| DY   | for soft package dyeing |               |                   |
| MT   | metallic                |               | 01/07/2013        |
| PL   | plastic                 |               |                   |

### T32 - yarn reel wrapping type

type of wrapping in which a package of yarn is wrapped

Agency name: eBIZ

tabella cod.: T32

File codes list (Generic code): [http://www.ebiz.enea.it/moda-ml/repository/codelist/draft/gc\\_T32.xml](http://www.ebiz.enea.it/moda-ml/repository/codelist/draft/gc_T32.xml)

| Code | Description      | Adoption note | Date of insertion |
|------|------------------|---------------|-------------------|
| XA   | without bag      |               |                   |
| XB   | paper bag        |               | 01/07/2013        |
| XD   | plastic film bag |               |                   |

### T33 - yarn outer packing

code specifying the type of outer wrapping or packing of a yarn

Agency name: eBIZ

tabella cod.: T33

File codes list (Generic code): [http://www.ebiz.enea.it/moda-ml/repository/codelist/draft/gc\\_T33.xml](http://www.ebiz.enea.it/moda-ml/repository/codelist/draft/gc_T33.xml)

| Code | Description          | Adoption note | Date of insertion |
|------|----------------------|---------------|-------------------|
| 00   |                      |               |                   |
| CB   | cartoon box          |               |                   |
| CC   | cartoon box 18 reels |               |                   |
| CD   | cartoon box 36 reels |               |                   |
| XD   | plastic film         |               |                   |

### T38 - transport conditions

special condition of transport or special service requested to the Forwarder

tabella cod.: T38

File codes list (Generic code): [http://www.ebiz.enea.it/moda-ml/repository/codelist/draft/gc\\_T38.xml](http://www.ebiz.enea.it/moda-ml/repository/codelist/draft/gc_T38.xml)

| Code | Description                            | Adoption note | Date of insertion |
|------|--|---------------|-------------------|
| ACC  | arrange customs clearance              |               |                   |
| CAL  | Carrier loads                          |               |                   |
| CAU  | Carrier unloads                        |               |                   |
| CMR  | CMR carnet                             |               |                   |
| FFN  | freight forwarders national conditions |               |                   |
| FLD  | special agreement for full loading     |               |                   |
| NCC  | do not arrange customs clearance       |               |                   |
| PPB  | packaging paid by Buyer                |               |                   |
| PPS  | packaging paid by Supplier             |               |                   |
| PRO  | proof of delivery                      |               |                   |
| RFR  | return container free                  |               |                   |
| RPC  | return container paid by Customer      |               |                   |
| RPS  | return container paid by Supplier      |               |                   |
| SHL  | Shipper loads                          |               |                   |
| SHU  | Consignee unloads                      |               |                   |

#### T4 - fabric piece inner packing (wrapping) 1

code specifying the type of inner wrapping/packing used for the fabric piece

Agency name: eBIZ

tabella cod.: T4

File codes list (Generic code): [http://www.ebiz.enea.it/moda-ml/repository/codelist/draft/gc\\_T4.xml](http://www.ebiz.enea.it/moda-ml/repository/codelist/draft/gc_T4.xml)

| Code | Description                        | Adoption note | Date of insertion |
|------|------------------------------------|---------------|-------------------|
| A    | Folded, whole width                |               |                   |
| B    | Folded, doubled                    |               |                   |
| C    | Folded, tube products              |               |                   |
| D    | Spoiled, whole width               |               |                   |
| E    | Spoiled, doubled, pli: left        |               |                   |
| F    | Spoiled, doubled, pli: right       |               |                   |
| G    | Rolled, whole width, single item   |               |                   |
| H    | Rolled, whole width, several items |               |                   |

|   |                       |  |  |
|---|-----------------------|--|--|
| I | Rolled, doubled       |  |  |
| J | Rolled, tube products |  |  |

#### T40 - type of transport means

means of transport, in general or referred to a specific leg

Agency name: eBIZ

tabella cod.: T40

File codes list (Generic code): [http://www.ebiz.enea.it/moda-ml/repository/codelist/draft/gc\\_T40.xml](http://www.ebiz.enea.it/moda-ml/repository/codelist/draft/gc_T40.xml)

| Code | Description | Adoption note | Date of insertion |
|------|-------------|---------------|-------------------|
| AIR  | aircraft    |               |                   |
| SHP  | ship        |               |                   |
| TRU  | truck       |               |                   |
| VAN  | van         |               |                   |

#### T41 - type of Allowance or Charge

coded specification of an Allowance or Charge (elaborated from UNECE 4465)

Agency name: eBIZ

tabella cod.: T41

File codes list (Generic code): [http://www.ebiz.enea.it/moda-ml/repository/codelist/draft/gc\\_T41.xml](http://www.ebiz.enea.it/moda-ml/repository/codelist/draft/gc_T41.xml)

| Code | Description             | Adoption note        | Date of insertion |
|------|-------------------------|----------------------|-------------------|
| 1    | Agreed settlement       |                      | 19/08/2018        |
| 10   | Costs for draft         |                      | 19/08/2018        |
| 11   | Bank charges            | DEPRECATED, use C BK | 19/08/2018        |
| 12   | Agent commission        |                      | 19/08/2018        |
| 14   | Wrong delivery          |                      | 19/08/2018        |
| 15   | Goods returned to agent |                      | 19/08/2018        |
| 16   | Goods partly returned   |                      | 19/08/2018        |



|    |                                  |                      |            |
|----|----------------------------------|----------------------|------------|
| 17 | Transport damage                 |                      | 19/08/2018 |
| 19 | Trade discount                   |                      | 19/08/2018 |
| 2  | Below specification goods        |                      | 19/08/2018 |
| 20 | Deduction for late delivery      | DEPRECATED, use C WB | 19/08/2018 |
| 21 | Advertising costs                |                      | 19/08/2018 |
| 22 | Customs duties                   |                      | 19/08/2018 |
| 23 | Telephone and postal costs       |                      | 19/08/2018 |
| 24 | Repair costs                     |                      | 19/08/2018 |
| 25 | Attorney fees                    |                      | 19/08/2018 |
| 26 | Taxes                            |                      | 19/08/2018 |
| 3  | Damaged goods                    |                      | 19/08/2018 |
| 30 | Direct payment to seller         |                      | 19/08/2018 |
| 32 | Goods not delivered              |                      | 19/08/2018 |
| 33 | Late delivery                    |                      | 19/08/2018 |
| 35 | Goods returned                   |                      | 19/08/2018 |
| 36 | Invoice not received             |                      | 19/08/2018 |
| 37 | Credit note to debtor/not to us  |                      | 19/08/2018 |
| 38 | Deducted bonus                   |                      | 19/08/2018 |
| 39 | Deducted discount                |                      | 19/08/2018 |
| 4  | Short delivery                   |                      | 19/08/2018 |
| 40 | Deducted freight costs           |                      | 19/08/2018 |
| 41 | Deduction against other invoices |                      | 19/08/2018 |

|    |  |  |            |
|----|--|--|------------|
| 42 | Credit balance(s)  |  | 19/08/2018 |
| 45 | Debit note to seller   |  | 19/08/2018 |
| 46 | Discount beyond terms  |  | 19/08/2018 |
| 48 | Allowance/charge error   |  | 19/08/2018 |
| 49 | Substitute product   |  | 19/08/2018 |
| 50 | Terms of sale error  |  | 19/08/2018 |
| 52 | Wrong invoice  |  | 19/08/2018 |
| 53 | Duplicate invoice  |  | 19/08/2018 |
| 54 | Weight error   |  | 19/08/2018 |
| 55 | Additional charge not authorized                                   |  | 19/08/2018 |
| 56 | Incorrect discount   |  | 19/08/2018 |
| 57 | Price change   |  | 19/08/2018 |
| 58 | Variation  |  | 19/08/2018 |
| 59 | Chargeback   |  | 19/08/2018 |
| 65 | Settlement to agent  |  | 19/08/2018 |
| 66 | Cash discount  |  | 19/08/2018 |
| 7  | Payment on account   |  | 19/08/2018 |
| 70 | Wrong monetary amount resulting from incorrect free goods quantity |  | 19/08/2018 |
| 72 | Temporary special promotion  |  | 19/08/2018 |
| 73 | Difference in tax rate   |  | 19/08/2018 |
| 74 | Quantity discount  |  | 19/08/2018 |
| 75 | Promotion discount   |  | 19/08/2018 |

|         |                                      |  |            |
|---------|--------------------------------------|--|------------|
| 76      | Cancellation deadline passed         |  | 19/08/2018 |
| 77      | Pricing discount                     |  | 19/08/2018 |
| 78      | Volume discount                      |  | 19/08/2018 |
| 79      | Sundry discount                      |  | 19/08/2018 |
| 8       | Returnable container charge included |  | 19/08/2018 |
| 9       | Invoice error                        |  | 19/08/2018 |
| AW<br>A | bonus for works ahead of schedule    |  |            |
| CBK     | bank charges                         |  |            |
| CCR     | servizio di corriere                 |  |            |
| CIN     | insurance                            |  |            |
| CLB     | labelling                            |  |            |
| CPK     | packing                              |  |            |
| CSP     | special packing                      |  |            |
| CW<br>B | penalty for works behind schedule    |  |            |

#### T421 - size system: nationality

nation or agency identifying the size system

Agency name: eBIZ

tabella cod.: T421

File codes list (Generic code): [http://www.ebiz.enea.it/moda-ml/repository/codelist/draft/gc\\_T421.xml](http://www.ebiz.enea.it/moda-ml/repository/codelist/draft/gc_T421.xml)

| Code | Description    | Adoption note | Date of insertion |
|------|----------------|---------------|-------------------|
| DE   | Germany        |               |                   |
| ES   | Spain          |               |                   |
| EU   | Europe         |               |                   |
| FR   | France         |               |                   |
| IT   | Italy          |               |                   |
| UK   | United Kingdom |               |                   |
| US   | USA            |               |                   |
| XX   | International  |               |                   |

### T422 - size system: market segment

market segment identifying the size system

Agency name: eBIZ

tabella cod.: T422

File codes list (Generic code): [http://www.ebiz.enea.it/moda-ml/repository/codelist/draft/gc\\_T422.xml](http://www.ebiz.enea.it/moda-ml/repository/codelist/draft/gc_T422.xml)

| Code | Description | Adoption note | Date of insertion |
|------|-------------|---------------|-------------------|
| B    | baby        |               |                   |
| C    | child       |               |                   |
| K    | kid         |               |                   |
| M    | man         |               |                   |
| U    | unisex      |               |                   |
| W    | woman       |               |                   |

### T423 - size system: base

base of the size system

Agency name: eBIZ

tabella cod.: T423

File codes list (Generic code): [http://www.ebiz.enea.it/moda-ml/repository/codelist/draft/gc\\_T423.xml](http://www.ebiz.enea.it/moda-ml/repository/codelist/draft/gc_T423.xml)

| Code | Description   | Adoption note | Date of insertion |
|------|---------------|---------------|-------------------|
| 1    | arab numbers  |               |                   |
| 2    | latin numbers |               |                   |
| 3    | symbols       |               |                   |
| 4    | letters       |               |                   |
| H    | height        |               |                   |
| L    | length        |               |                   |
| U    | unic          |               |                   |
| W    | weight        |               |                   |

### T44 - additional code type

qualifier of the additional coding of a product

Agency name: eBIZ

tabella cod.: T44

File codes list (Generic code): [http://www.ebiz.enea.it/moda-ml/repository/codelist/draft/gc\\_T44.xml](http://www.ebiz.enea.it/moda-ml/repository/codelist/draft/gc_T44.xml)

| Code | Description                 | Adoption note | Date of insertion |
|------|-----------------------------|---------------|-------------------|
| CC   | colour card                 |               |                   |
| CL   | sales collection            |               |                   |
| CO   | company identification code |               | 08/09/2017        |
| DY   | dye number                  |               |                   |
| LT   | lot number                  |               |                   |
| MDI  | Made in                     |               | 08/09/2017        |
| MS   | manufacturing state         |               |                   |
| PKG  | packaging                   |               | 09/09/2014        |
| PL   | product line                |               |                   |
| RGB  | RGB value                   |               |                   |
| SE   | selvedge code               |               |                   |

#### T48 - garment part type

code specifying the type of component or part of a garment (sleeve, neck, ...)

Agency name: eBIZ

tabella cod.: T48

File codes list (Generic code): [http://www.ebiz.enea.it/moda-ml/repository/codelist/draft/gc\\_T48.xml](http://www.ebiz.enea.it/moda-ml/repository/codelist/draft/gc_T48.xml)

| Code | Description       | Adoption note | Date of insertion |
|------|-------------------|---------------|-------------------|
| BB   | bottom back       |               | 01/08/2018        |
| BF   | bottom fore/front |               | 01/08/2018        |
| CO   | collar            |               | 01/08/2018        |
| CU   | cuff              |               | 01/08/2018        |
| DV   | fore              |               |                   |
| EM   | embroidery        |               | 01/08/2018        |
| OC   | other component   |               | 01/08/2018        |
| PO   | pocket            |               | 01/08/2018        |
| SC   | back              |               |                   |
| SL   | sleeve            |               | 01/08/2018        |
| TB   | top back          |               | 01/08/2018        |

|    |                |  |            |
|----|----------------|--|------------|
| TF | top fore/front |  | 01/08/2018 |
|----|----------------|--|------------|

### T5 - fabric piece inner packing (wrapping) 2

code specifying the sub-type of inner wrapping/packing used for the fabric piece

Agency name: eBIZ

tabella cod.: T5

File codes list (Generic code): [http://www.ebiz.enea.it/moda-ml/repository/codelist/draft/gc\\_T5.xml](http://www.ebiz.enea.it/moda-ml/repository/codelist/draft/gc_T5.xml)

| Code | Description   | Adoption note | Date of insertion |
|------|---|---------------|-------------------|
| A    | Open  |               |                   |
| B    | Folded once, not looped                                       |               |                   |
| C    | Folded twice, not looped                                      |               |                   |
| H    | Folded once, looped   |               |                   |
| I    | Folded twice, looped  |               |                   |
| J    | Without inner object, right side inside                       |               |                   |
| K    | On carton or spooling plank, right side inside                |               |                   |
| L    | On spool (for pressure sensitive products), right side inside |               |                   |
| M    | Without inner object, left side inside                        |               |                   |
| N    | On carton or spooling plank, left side inside                 |               |                   |
| O    | On spool (for pressure sensitive products), left side inside  |               |                   |
| P    | Without inner object, right side inside (deprecated code)     |               |                   |
| Q    | On carton, right side inside                                  |               |                   |
| R    | On wooden stick, right side inside                            |               |                   |
| S    | Without inner object, left side inside (deprecated code)      |               |                   |
| T    | On carton, left side inside                                   |               |                   |
| U    | On wooden stick, left side inside                             |               |                   |

### T6 - fabric piece outer packing

code specifying the type of outer wrapping or packing used for the fabric piece

Agency name: eBIZ

tabella cod.: T6

File codes list (Generic code): [http://www.ebiz.enea.it/moda-ml/repository/codelist/draft/gc\\_T6.xml](http://www.ebiz.enea.it/moda-ml/repository/codelist/draft/gc_T6.xml)

| Code | Description | Adoption note | Date of insertion |
|------|-------------|---------------|-------------------|
|------|-------------|---------------|-------------------|

|   |  |  |  |
|---|--|--|--|
| 0 | Not wrapped                              |  |  |
| 1 | Totally wrapped                          |  |  |
| 2 | Wrapped, one side open                   |  |  |
| 3 | Wrapped, both sides open                 |  |  |
| 4 | Wrapped, one side open, with show corner |  |  |
| 5 | Wrapped in cartons                       |  |  |
| 6 | Double wrapped                           |  |  |

### T61 - duty or tax or fee type

duty or tax or fee type

Agency name: eBIZ

tabella cod.: T61

File codes list (Generic code): [http://www.ebiz.enea.it/moda-ml/repository/codelist/draft/gc\\_T61.xml](http://www.ebiz.enea.it/moda-ml/repository/codelist/draft/gc_T61.xml)

| Code | Description       | Adoption note | Date of insertion |
|------|-------------------|---------------|-------------------|
| BOL  | stamp duty        |               | 01/07/2013        |
| CUD  | customs duty      |               | 01/07/2013        |
| ENV  | environmental tax |               | 01/07/2013        |
| FRE  | no tax            |               | 01/07/2013        |
| OTH  | other tax charges |               | 01/07/2013        |
| VAT  | value added tax   |               | 01/07/2013        |

### T62 - duty or tax or fee category

duty or tax or fee category

Agency name: eBIZ

tabella cod.: T62

File codes list (Generic code): [http://www.ebiz.enea.it/moda-ml/repository/codelist/draft/gc\\_T62.xml](http://www.ebiz.enea.it/moda-ml/repository/codelist/draft/gc_T62.xml)

| Code | Description               | Adoption note | Date of insertion |
|------|---------------------------|---------------|-------------------|
| AA   | lower than standard rate  |               | 01/07/2013        |
| E    | tax not applicable        |               | 01/07/2013        |
| H    | higher than standard rate |               | 01/07/2013        |
| O    | outside scope of tax      |               | 01/07/2013        |
| S    | standard rate             |               | 01/07/2013        |

|   |                 |  |            |
|---|-----------------|--|------------|
| Z | zero rate goods |  | 01/07/2013 |
|---|-----------------|--|------------|

### T8 - Modes of Transport

way of transport, in general or referred to the specified leg

Agency name: eBIZ

tabella cod.: T8

File codes list (Generic code): [http://www.ebiz.enea.it/moda-ml/repository/codelist/draft/gc\\_T8.xml](http://www.ebiz.enea.it/moda-ml/repository/codelist/draft/gc_T8.xml)

| Code | Description            | Adoption note | Date of insertion |
|------|------------------------|---------------|-------------------|
| 1    | MARITIME TRANSPORT     |               |                   |
| 10   | Courier                |               | 01/07/2013        |
| 2    | RAIL TRANSPORT         |               |                   |
| 3    | ROAD TRANSPORT         |               |                   |
| 4    | AIR TRANSPORT          |               |                   |
| 5    | MAIL                   |               |                   |
| 6    | AIR + SHIP TRANSPORT   |               |                   |
| 8    | INLAND WATER TRANSPORT |               |                   |
| 9    | MODE UNKNOWN           |               |                   |

### T9 - ISO4217 - Currency

currency code

Agency name: ISO

tabella cod.: T9

File codes list (Generic code): [http://www.ebiz.enea.it/moda-ml/repository/codelist/draft/gc\\_T9.xml](http://www.ebiz.enea.it/moda-ml/repository/codelist/draft/gc_T9.xml)

Table not printed: there are 205 elements, more than the maximum specified for printing: 99.