



<http://www.ebiz-tcf.eu>

## IMPLEMENTATION GUIDE

includes COMPARISON BETWEEN CURRENT and LAST  
PREVIOUSLY RELEASED VERSION

TRANSACTION "FASHION COMMISSION ORDER"

Version: v2018-1

Date of release: 18/7/2019

Document code: G040rv

technical Documentation: <http://www.ebiz.enea.it>

XML Schemas repository: <http://www.ebiz.enea.it/moda-ml/repository/schema/v2018-1/default.asp>

Guides repository: <http://www.ebiz.enea.it/moda-ml/repository/guide/v2018-1/default.asp>

Guide filename: G040rv-eBIZ-FashionCommissionOrder.pdf

# 1. BUSINESS DESCRIPTION

## 1.1 Scope

This guide is intended to illustrate the standard XML form of the "FASHION COMMISSION ORDER" document type to companies in the fashion sector, providing instructions for their use in the electronic commerce context between fashion subcontractors and their customers as illustrated in the enclosed diagram

All the rules necessary for the construction and validation of the document are expressed through a specific XML schema, which is presented in detail in paragraph 3.

## 1.2 Generalities

The FASHION Commission Order is used by the commissioner Company to commit to a Sub-contractor

Each commission order can include one or more operations of the manufacturing cycle, each one corresponding to a line item

The document can be used either to order the manufacturing of finished goods or of component parts of them.

When the Commissioner orders a sequence of operations to different Sub-contractors, he can use this document also to dispose the delivering of semifinished goods from one Sub-contractor to the next.

This document specifies only the technology (when necessary) and the characteristics of the final product and of the initial goods (components) to be used in the manufacturing; it can also give directives that involve also n<sup>th</sup>-tier sub-subcontractors in order to be compliant with requirements like CITES or Country of Origin

The output product specified in each line item can be the input component in a following line item also in the same Commission order.

## 1.3. Possible scenario

Subcontracted fashion manufacturing

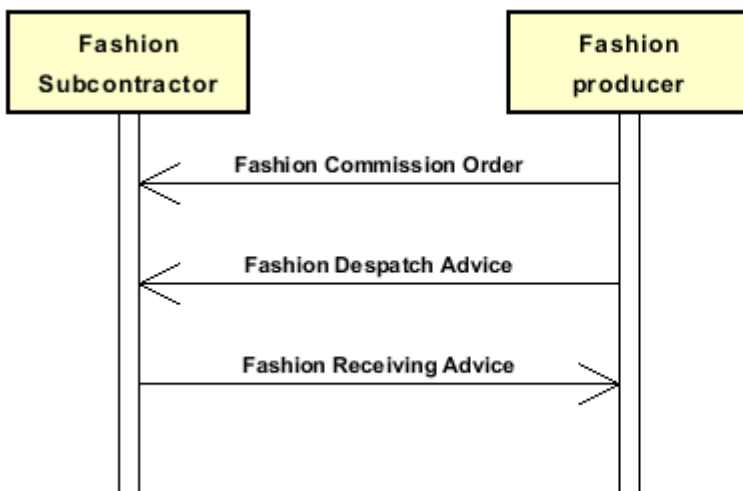



## 2. IMPLEMENTATION GUIDE

### 2.1 General structure of XML document

All the business data that can be exchanged through this class of documents are shown in the following "document structure", that provides a simplified vision of the Schema.

In particular:

- the two numbers following each element define its "cardinality" (minimum and maximum number of occurrences); the minimum equal zero indicates that the element is optional, the minimum greater than zero indicates that is mandatory;
- the bold character denotes the complex elements (aggregates of simple elements) that were built for the sake of functionality and re-usability of some complex informations sets. The child elements in each parent element are easily spotted as "indented";
- the symbol "@" denotes an attribute of the preceding element; here "the usage indicator (optional, required, ...)" is shown in square brackets.

#### Legenda

- N: new element
- U: updated properties
- P: changes in children
- p: is a changed child
- A: changes in attributes
- a: is a new or changed attribute
- \*: is a subtype

### Structure

#### KnitClothOrder (AP)

@msgfunction [Optional] [Default= OR]

@version [Optional] [Default= 2018-1]

@useProfile [Optional]

@KCCOtype [Optional] (Na\*)

```
| KCCOheader 1-1 (P)
| | msgN 1-1
| | - choose -
| | msgID 0-1
| | - or -
| | docID 0-1
| | @numberingOrg [Optional]
| | - end choose -
| | msgDate 1-1
| | @dateForm [Optional]
| | season 0-1 (A)
| | @numberingOrg [Optional] (a)
| | @codeList [Optional] (a)
| | @listName [Optional] (a)
| | @listVersion [Optional] (a)
| | msgCurrency 0-1
| | validityStart 0-1 (p)
| | @dateForm [Optional]
| | validityEnd 0-1 (p)
| | @dateForm [Optional]
| | refDoc 0-9 (P)
| | @docType [Required]
| | | docID 1-2 (p)
| | | @numberingOrg [Optional]
| | | docDate 0-1
```

- | @dateForm [Optional]
- | season 0-1 (A)
- | @numberingOrg [Optional] (a)
- | @codeList [Optional] (a)
- | @listName [Optional] (a)
- | @listVersion [Optional] (a)
- | itemID 0-1 (U)
- | **attachment 0-1 (N)**
- | | @uid [Optional]
- | | | fileName 0-1 (N)
- | | | @numberingOrg [Optional]
- | | | binaryObject 0-1 (N)
- | | | @format [Optional] (N)
- | | | @mime [Optional] (N)
- | | | @encoding [Optional] (N)
- | | | @characterSet [Optional] (N)
- | | | **externalReference 0-99 (N)**
- | | | | uri 1-1 (N)
- | | | | @isURL [Optional] [Default= true] (Na)
- | | | | mimeTypeCode 0-1 (N)
- | | | | formatCode 0-1 (N)
- | | | | encodingCode 0-1 (N)
- | | | | characterSetCode 0-1 (N)
- | **buyer 1-1 (AP)**
- | | @logo [Optional]
- | | @sender [Optional] (a\*)
- | | | id 1-1 (p)
- | | | @numberingOrg [Optional]
- | | | additionalIdentifier 0-9 (N)
- | | | @numberingOrg [Optional] (a)
- | | | @idQualifier [Optional] (Na)
- | | | legalName 0-1 (U)
- | | | dept 0-1
- | | | subDept 0-1 (N)
- | | | person 0-1
- | | | | @email [Optional]
- | | | | @phone [Optional]
- | | | | @fax [Optional]
- | | | street 0-1
- | | | city 0-1
- | | | subCountry 0-1
- | | | country 0-1
- | | | postCode 0-1
- | **subContractor 1-1 (AP)**
- | | @sender [Optional] (a\*)
- | | | id 1-1
- | | | @numberingOrg [Optional]
- | | | legalName 0-1 (U)
- | | | dept 0-1
- | | | subDept 0-1 (N)
- | | | person 0-1
- | | | | @email [Optional]
- | | | | @phone [Optional]
- | | | | @fax [Optional]
- | | | street 0-1
- | | | city 0-1
- | | | subCountry 0-1
- | | | country 0-1
- | | | postCode 0-1
- | **thirdParty 0-5 (AP)**
- | | @VAT [Optional]

```

| | @role [Required]
| | @sender [Optional] (a*)
| | | id 1-1
| | | | @numberingOrg [Optional]
| | | | legalName 0-1 (U)
| | | | dept 0-1
| | | | subDept 0-1 (N)
| | | | person 0-1
| | | | | @email [Optional]
| | | | | @phone [Optional]
| | | | | @fax [Optional]
| | | | street 0-1
| | | | city 0-1
| | | | subCountry 0-1
| | | | country 0-1
| | | | postCode 0-1
| | | note 0-99
| | | @numberingOrg [Optional]
| | | @codeList [Optional]
| | | @noteLabel [Optional]
| | terms 0-1 (P)
| | | payment 0-5
| | | | @finDiscount [Optional]
| | | | @finSurcharge [Optional]
| | | | - choose -
| | | | | payTerm 1-1
| | | | | - or -
| | | | | payTermText 1-1 (U)
| | | | | - end choose -
| | | | | payMode 0-1
| | | | insPayment 0-5
| | | | | @part [Required]
| | | | | - choose -
| | | | | | payTerm 1-1
| | | | | | - or -
| | | | | | payTermText 1-1 (U)
| | | | | | - end choose -
| | | | | | payMode 0-1
| | | | trade 0-1
| | | | - choose -
| | | | | incoTermText 1-1 (U)
| | | | | - or -
| | | | | | incoTerm 1-1
| | | | | | - end choose -
| | | | | | location 0-1
| | | | | | | @LRI [Optional]
| | | | transInfo 0-5 (pAP)
| | | | | @transReason [Optional]
| | | | | @progr [Optional] (N)
| | | | | | transMode 1-1
| | | | | | carrier 0-1
| | | | | | | deliveryPlace 0-1 (U)
| | | | | | | grossWeight 0-1
| | | | | | | | @um [Required]
| | | | | | | | netWeight 0-1
| | | | | | | | | @um [Required]
| | | | | | | transMeans 0-1
| | | | | | | transCondition 0-3
| | | | | | | | transConditionText 0-1 (U)
| | | | | | | | | despatchPlace 0-1 (N)

```

| | | despatchDate 0-1 (N)  
 | | | @dateForm [Optional] (a)  
 | | | delEffectiveDate 0-1 (p)  
 | | | @dateForm [Optional]  
 | | **allowanceCharge 0-9 (A)**  
 | | | @um [Optional] (a)  
 | | | @VAT [Optional]  
 | | | @minQty [Optional] (a)  
 | | | @currency [Optional] (a)  
 | | | @maxQty [Optional] (N)  
 | | | @isCharge [Optional] (N)  
 | | | - choose -  
 | | | | AC\_category 1-1  
 | | | - or -  
 | | | | AC\_categoryText 1-1 (U)  
 | | | - end choose -  
 | | | - choose -  
 | | | | AC\_percent 1-1  
 | | | - or -  
 | | | | AC\_amount 1-1 (A)  
 | | | | @currency [Optional] (a)  
 | | | - end choose -  
 | | | **dtScheme 0-1 (P)**  
 | | | | @taxType [Required]  
 | | | | taxCategory 0-1  
 | | | | taxRate 0-1  
 | | | | legalRef 0-1 (A)  
 | | | | @numberingOrg [Optional]  
 | | | | @codeList [Optional]  
 | | | | @listName [Optional]  
 | | | | @listVersion [Optional]  
 | | | | note 0-99  
 | | | | @numberingOrg [Optional]  
 | | | | @codeList [Optional]  
 | | | | @noteLabel [Optional]

| | **garComInfo 0-1 (N\*)**  
 | | | @endUse [Optional] (a)  
 | | | season 0-1 (A)  
 | | | | @numberingOrg [Optional] (a)  
 | | | | @codeList [Optional] (a)  
 | | | | @listName [Optional] (a)  
 | | | | @listVersion [Optional] (a)  
 | | | brand 0-1 (N)  
 | | | | @numberingOrg [Optional] (a)  
 | | | | @codeList [Optional] (a)  
 | | | | @listName [Optional] (a)  
 | | | | @listVersion [Optional] (a)  
 | | | productLine 0-1 (N)  
 | | | | @numberingOrg [Optional] (a)  
 | | | | @codeList [Optional] (a)  
 | | | | @listName [Optional] (a)  
 | | | | @listVersion [Optional] (a)  
 | | | project 0-1 (U)  
 | | | operationalCode 0-19 (N)  
 | | | | @numberingOrg [Optional] (a)  
 | | | | @codeList [Optional] (a)  
 | | | | @listName [Optional] (a)  
 | | | | @listVersion [Optional] (a)  
 | | | | @codeQualifier [Optional] (Na)  
 | | | deliveryDate 0-1 (p)

```

| | @dateForm [Optional]
| | specDate 0-1 (p)
| | @dateForm [Optional]
- choose -
| | yarnPack 0-1 (p)
| | | yarnReel 1-1
| | | | @reelType [Required]
| | | | @reelMat [Optional]
| | | | | yarnReelD 0-1
| | | | | | @um [Required]
| | | | | | yarnReelH 0-1
| | | | | | | @um [Required]
| | | | | | | yarnConeAngle 0-1
| | | | | | | yarnReelQty 0-2
| | | | | | | | @um [Required]
| | | | | | | | label 0-1
| | | | | | | | labelWrit 0-1
| | | | yarnInWrap 0-1
| | | | | yarnReelWrap 1-1
| | | | | | label 0-1
| | | | | | labelWrit 0-1
| | | - choose -
| | | | yarnOutWrapText 0-1 (U)
| | | - or -
| | | | yarnOutWrap 0-1
| | | - end choose -
- or -
| | piecePack 0-1 (p)
| | | - choose -
| | | | piecePackText 1-1 (U)
| | | | - or -
| | | | | pieceInnWrap1 1-1
| | | | | pieceInnWrap2 0-1
| | | | | pieceOutWrap 0-1
| | | | - end choose -
- or -
| | acsPack 0-1 (U)
| | | - choose -
| | | | acsPackCode 1-1 (AU)
| | | | | @numberingOrg [Optional] (a)
| | | | | @codeList [Optional] (a)
| | | | | @listName [Optional] (a)
| | | | | @listVersion [Optional] (a)
| | | | - or -
| | | | | acsPackText 1-1 (U)
| | | | - end choose -
- or -
| | garPack 0-1 (N)
| | | - choose -
| | | | garPackCode 1-1 (N)
| | | | | @numberingOrg [Optional] (a)
| | | | | @codeList [Optional] (a)
| | | | | @listName [Optional] (a)
| | | | | @listVersion [Optional] (a)
| | | | - or -
| | | | | garPackText 1-1 (N)
| | | | - end choose -
- end choose -
| | note 0-99
| | | @numberingOrg [Optional]
| | | @codeList [Optional]

```



| | @noteLabel [Optional]

| **KCCObody 1-1**

| | **KCCOitem 1-unbounded (P)**  
| | @productLevel [Optional] [Default= END]

| | lineN 1-1  
| | @VAT [Optional]  
| | lineID 0-1 (N)  
| | priority 0-1 (N)

| | **apparelProd 1-1 (P)**  
| | - choose -

| | | **garmentPartCode 1-2 (P)**  
| | | @numberingOrg [Optional]  
| | | gPart 1-1  
| | | mod 1-1  
| | | @numberingOrg [Optional]  
| | | @codeList [Optional]  
| | | @listName [Optional]  
| | | @listVersion [Optional]  
| | | fabric 0-1  
| | | @numberingOrg [Optional]  
| | | @codeList [Optional]  
| | | @listName [Optional]  
| | | @listVersion [Optional]  
| | | color 0-1  
| | | @numberingOrg [Optional]  
| | | @codeList [Optional]  
| | | @listName [Optional]  
| | | @listVersion [Optional]  
| | | added 0-19  
| | | @numberingOrg [Optional]  
| | | @addType [Optional]  
| | | size 0-1 (A)  
| | | @numberingOrg [Optional] (a)  
| | | @codeList [Optional]  
| | | @listName [Optional] (a)  
| | | @listVersion [Optional] (a)  
| | | description 0-unbounded (AU)  
| | | @ln [Optional] (N)

| | - or -

| | | **garmentCode 1-2**  
| | | @numberingOrg [Optional]

| | - choose -

| | | **garmentCodeB 1-1 (P)**  
| | | @numberingOrg [Optional]  
| | | mod 1-1  
| | | @numberingOrg [Optional]  
| | | @codeList [Optional]  
| | | @listName [Optional]  
| | | @listVersion [Optional]  
| | | fabric 0-1  
| | | @numberingOrg [Optional]  
| | | @codeList [Optional]  
| | | @listName [Optional]  
| | | @listVersion [Optional]  
| | | color 0-1  
| | | @numberingOrg [Optional]  
| | | @codeList [Optional]  
| | | @listName [Optional]  
| | | @listVersion [Optional]

| | | **garmentVariant 0-9 (N)**

```

| | | | | variantType 1-1 (N)
| | | | | @numberingOrg [Optional] (a)
| | | | | @codeList [Optional] (a)
| | | | | @listName [Optional] (a)
| | | | | @listVersion [Optional] (a)
| | | | | variantCode 1-1 (N)
| | | | | @numberingOrg [Optional] (a)
| | | | | @codeList [Optional] (a)
| | | | | @listName [Optional] (a)
| | | | | @listVersion [Optional] (a)
| | | | | drop 0-1 (A)
| | | | | @numberingOrg [Optional] (a)
| | | | | @codeList [Optional]
| | | | | @listName [Optional] (a)
| | | | | @listVersion [Optional] (a)
| | | | | size 0-1 (A)
| | | | | @numberingOrg [Optional] (a)
| | | | | @codeList [Optional]
| | | | | @listName [Optional] (a)
| | | | | @listVersion [Optional] (a)
| | | | | artGroup 0-1
| | | | | @numberingOrg [Optional]
| | | | | @codeList [Optional]
| | | | | @listName [Optional]
| | | | | @listVersion [Optional]
| | | | | added 0-9
| | | | | @numberingOrg [Optional]
| | | | | @addType [Optional]
| | | | | description 0-unbounded (AU)
| | | | | @ln [Optional] (N)

```

- or -

```

| | | | | garmentCodeA 1-1 (P)
| | | | | art 1-1 (U)
| | | | | @numberingOrg [Optional]
| | | | | @codeList [Optional]
| | | | | @listName [Optional]
| | | | | @listVersion [Optional]
| | | | | description 0-unbounded (AU)
| | | | | @ln [Optional] (N)

```

- end choose -

- end choose -

```

| | | | | lotN 0-1
| | | | | @numberingOrg [Optional]
| | | | | dyeN 0-1
| | | | | @numberingOrg [Optional]
| | | | | qty 1-2
| | | | | @um [Required]
| | | | | csRange 0-99 (P)
| | | | | @numberingOrg [Optional]
| | | | | @sizeSystemNat [Optional]
| | | | | @sizeSystemSeg [Optional]
| | | | | @sizeSystemBase [Optional]
| | | | | @sizeSystemID [Optional]
| | | | | color 0-1
| | | | | @numberingOrg [Optional]
| | | | | @codeList [Optional]
| | | | | @listName [Optional]
| | | | | @listVersion [Optional]
| | | | | garmentVariant 0-9 (N)
| | | | | variantType 1-1 (N)
| | | | | @numberingOrg [Optional] (a)

```

```

| | | | | @codeList [Optional] (a)
| | | | | @listName [Optional] (a)
| | | | | @listVersion [Optional] (a)
| | | | | variantCode 1-1 (N)
| | | | | @numberingOrg [Optional] (a)
| | | | | @codeList [Optional] (a)
| | | | | @listName [Optional] (a)
| | | | | @listVersion [Optional] (a)
| | | | | drop 0-1 (A)
| | | | | @numberingOrg [Optional] (a)
| | | | | @codeList [Optional]
| | | | | @listName [Optional] (a)
| | | | | @listVersion [Optional] (a)
| | | | | sizeMatrix 1-1
| | | | | | sizeRow 1-99 (P)
| | | | | | | additionalComponentCode 0-9 (N)
| | | | | | | @numberingOrg [Optional] (a)
| | | | | | | @codeList [Optional] (a)
| | | | | | | @listName [Optional] (a)
| | | | | | | @listVersion [Optional] (a)
| | | | | | | drop 0-1 (A)
| | | | | | | @numberingOrg [Optional] (a)
| | | | | | | @codeList [Optional]
| | | | | | | @listName [Optional] (a)
| | | | | | | @listVersion [Optional] (a)
| | | | | | | size 1-1 (A)
| | | | | | | @numberingOrg [Optional] (a)
| | | | | | | @codeList [Optional]
| | | | | | | @listName [Optional] (a)
| | | | | | | @listVersion [Optional] (a)
| | | | | | | qty 0-1
| | | | | | | @um [Required]
| | | | | | | itemsList 0-1 (N)
| | | | | | | | qualityLevel 0-1 (N)
| | | | | | | | @numberingOrg [Optional] (a)
| | | | | | | | @codeList [Optional] (a)
| | | | | | | | @listName [Optional] (a)
| | | | | | | | @listVersion [Optional] (a)
| | | | | | | | itemIdentification 1-unbounded (N)
| | | | | | | | | serialN 1-9 (AU)
| | | | | | | | | @numberingOrg [Optional]
| | | | | | | | | @idQualifier [Optional] (N)
| | | | | note 0-99
| | | | | @numberingOrg [Optional]
| | | | | @codeList [Optional]
| | | | | @noteLabel [Optional]
| | | | | price 0-1 (AU)
| | | | | @um [Optional]
| | | | | @priceQualifier [Optional] [Default= NET]
| | | | | @currency [Optional] (a)
| | | | | deliveryDate 0-1
| | | | | @dateForm [Optional]
| | | | | thirdParty 0-5 (AP)
| | | | | @VAT [Optional]
| | | | | @role [Required]
| | | | | @sender [Optional] (a*)
| | | | | | id 1-1
| | | | | | @numberingOrg [Optional]
| | | | | | legalName 0-1 (U)
| | | | | | dept 0-1
| | | | | | subDept 0-1 (N)

```

```

| | | | person 0-1
| | | |   @email [Optional]
| | | |   @phone [Optional]
| | | |   @fax [Optional]
| | | | street 0-1
| | | | city 0-1
| | | | subCountry 0-1
| | | | country 0-1
| | | | postCode 0-1
| | | | garTecSheet 0-1
| | | |   garmentCode 1-2
| | | |     @numberingOrg [Optional]
| | | |   - choose -
| | | |     garmentCodeB 1-1 (P)
| | | |       @numberingOrg [Optional]
| | | |         mod 1-1
| | | |           @numberingOrg [Optional]
| | | |           @codeList [Optional]
| | | |           @listName [Optional]
| | | |           @listVersion [Optional]
| | | |         fabric 0-1
| | | |           @numberingOrg [Optional]
| | | |           @codeList [Optional]
| | | |           @listName [Optional]
| | | |           @listVersion [Optional]
| | | |         color 0-1
| | | |           @numberingOrg [Optional]
| | | |           @codeList [Optional]
| | | |           @listName [Optional]
| | | |           @listVersion [Optional]
| | | |       garmentVariant 0-9 (N)
| | | |         variantType 1-1 (N)
| | | |           @numberingOrg [Optional] (a)
| | | |           @codeList [Optional] (a)
| | | |           @listName [Optional] (a)
| | | |           @listVersion [Optional] (a)
| | | |         variantCode 1-1 (N)
| | | |           @numberingOrg [Optional] (a)
| | | |           @codeList [Optional] (a)
| | | |           @listName [Optional] (a)
| | | |           @listVersion [Optional] (a)
| | | |         drop 0-1 (A)
| | | |           @numberingOrg [Optional] (a)
| | | |           @codeList [Optional]
| | | |           @listName [Optional] (a)
| | | |           @listVersion [Optional] (a)
| | | |         size 0-1 (A)
| | | |           @numberingOrg [Optional] (a)
| | | |           @codeList [Optional]
| | | |           @listName [Optional] (a)
| | | |           @listVersion [Optional] (a)
| | | |         artGroup 0-1
| | | |           @numberingOrg [Optional]
| | | |           @codeList [Optional]
| | | |           @listName [Optional]
| | | |           @listVersion [Optional]
| | | |         added 0-9
| | | |           @numberingOrg [Optional]
| | | |           @addType [Optional]
| | | |         description 0-unbounded (AU)
| | | |           @ln [Optional] (N)

```

- or -

**garmentCodeA 1-1 (P)**  
| art 1-1 (U)  
| @numberingOrg [Optional]  
| @codeList [Optional]  
| @listName [Optional]  
| @listVersion [Optional]  
| description 0-unbounded (AU)  
| @ln [Optional] (N)

- end choose -

**refDoc 0-9 (P)**  
| @docType [Required]  
| docID 1-2  
| @numberingOrg [Optional]  
| docDate 0-1  
| @dateForm [Optional]  
| season 0-1 (A)  
| @numberingOrg [Optional] (a)  
| @codeList [Optional] (a)  
| @listName [Optional] (a)  
| @listVersion [Optional] (a)  
| itemID 0-1 (U)  
**attachment 0-1 (N)**  
| @uid [Optional]  
| fileName 0-1 (N)  
| @numberingOrg [Optional] (a)  
| binaryObject 0-1 (N)  
| @format [Optional] (Na)  
| @mime [Optional] (Na)  
| @encoding [Optional] (Na)  
| @characterSet [Optional] (Na)  
**externalReference 0-99 (N)**  
| uri 1-1 (N)  
| @isURL [Optional] [Default= true] (Na)  
| mimeTypeCode 0-1 (N)  
| formatCode 0-1 (N)  
| encodingCode 0-1 (N)  
| characterSetCode 0-1 (N)

**fabricCompos 0-1**  
| percCompos 1-9  
| @fibre [Required]  
customsStat 0-1  
grossWeight 0-1  
@um [Required]  
netWeight 0-1  
@um [Required]  
**garSizeSet 0-1 (A)**  
| @numberingOrg [Optional]  
| @sizeSystemNat [Optional]  
| @sizeSystemSeg [Optional]  
| @sizeSystemBase [Optional]  
| @sizeSystemID [Optional]  
| **garSizeTier 1-9**  
| | garSizeCode 1-1 (A)  
| | @numberingOrg [Optional] (a)  
| | @codeList [Optional] (a)  
| | @listName [Optional] (a)  
| | @listVersion [Optional] (a)  
| | sizeStart 1-1  
| | sizeEnd 0-1

**garMeaSet 0-99**

				garAttrib 1-1
				<b>garMea 1-9</b>
				size 0-1 (A)
				@numberingOrg [Optional] (a)
				@codeList [Optional]
				@listName [Optional] (a)
				@listVersion [Optional] (a)
				specValue 1-1
				@um [Optional]
				@source [Optional]
				@method [Optional]
				@application [Optional]
				@CV [Optional]
				<b>garConsumptionSet 0-99 (P)</b>
				- choose -
				<b>acsCode 1-1 (U)</b>
				@numberingOrg [Optional]
				art 1-1 (U)
				@numberingOrg [Optional]
				@codeList [Optional]
				@listName [Optional]
				@listVersion [Optional]
				pattern 0-1
				@numberingOrg [Optional]
				@codeList [Optional]
				@listName [Optional]
				@listVersion [Optional]
				color 0-1
				@numberingOrg [Optional]
				@codeList [Optional]
				@listName [Optional]
				@listVersion [Optional]
				added 0-9
				@numberingOrg [Optional]
				@addType [Optional]
				description 0-unbounded (AU)
				@ln [Optional] (N)
				- or -
				<b>texCode 1-1 (P)</b>
				@numberingOrg [Optional]
				art 1-1 (U)
				@numberingOrg [Optional]
				@codeList [Optional]
				@listName [Optional]
				@listVersion [Optional]
				pattern 0-1
				@numberingOrg [Optional]
				@codeList [Optional]
				@listName [Optional]
				@listVersion [Optional]
				color 0-1
				@numberingOrg [Optional]
				@codeList [Optional]
				@listName [Optional]
				@listVersion [Optional]
				added 0-9
				@numberingOrg [Optional]
				@addType [Optional]
				description 0-unbounded (pAU)
				@ln [Optional] (N)
				- or -

**yarnCode 1-1 (P)**  
 @numberingOrg [Optional] [Default= CL]  
 | art 1-1 (U)  
 | | @numberingOrg [Optional]  
 | | @codeList [Optional]  
 | | @listName [Optional]  
 | | @listVersion [Optional]  
 | color 0-1  
 | | @numberingOrg [Optional]  
 | | @codeList [Optional]  
 | | @listName [Optional]  
 | | @listVersion [Optional]  
 | added 0-9  
 | | @numberingOrg [Optional]  
 | | @addType [Optional]  
 | description 0-unbounded (AU)  
 | | @ln [Optional] (N)

- or -

**garmentPartCode 1-1 (P)**  
 @numberingOrg [Optional]  
 | gPart 1-1  
 | mod 1-1  
 | | @numberingOrg [Optional]  
 | | @codeList [Optional]  
 | | @listName [Optional]  
 | | @listVersion [Optional]  
 | fabric 0-1  
 | | @numberingOrg [Optional]  
 | | @codeList [Optional]  
 | | @listName [Optional]  
 | | @listVersion [Optional]  
 | color 0-1  
 | | @numberingOrg [Optional]  
 | | @codeList [Optional]  
 | | @listName [Optional]  
 | | @listVersion [Optional]  
 | added 0-19  
 | | @numberingOrg [Optional]  
 | | @addType [Optional]  
 | size 0-1 (A)  
 | | @numberingOrg [Optional] (a)  
 | | @codeList [Optional]  
 | | @listName [Optional] (a)  
 | | @listVersion [Optional] (a)  
 | description 0-unbounded (AU)  
 | | @ln [Optional] (N)

- or -

**garmentCode 1-1**  
 @numberingOrg [Optional]

- choose -

**garmentCodeB 1-1 (P)**  
 @numberingOrg [Optional]  
 | mod 1-1  
 | | @numberingOrg [Optional]  
 | | @codeList [Optional]  
 | | @listName [Optional]  
 | | @listVersion [Optional]  
 | fabric 0-1  
 | | @numberingOrg [Optional]  
 | | @codeList [Optional]  
 | | @listName [Optional]

```

| | | | | @listVersion [Optional]
| | | | | color 0-1
| | | | | @numberingOrg [Optional]
| | | | | @codeList [Optional]
| | | | | @listName [Optional]
| | | | | @listVersion [Optional]
| | | | | garmentVariant 0-9 (N)
| | | | | | variantType 1-1 (N)
| | | | | | | @numberingOrg [Optional] (a)
| | | | | | | @codeList [Optional] (a)
| | | | | | | @listName [Optional] (a)
| | | | | | | @listVersion [Optional] (a)
| | | | | | variantCode 1-1 (N)
| | | | | | | @numberingOrg [Optional] (a)
| | | | | | | @codeList [Optional] (a)
| | | | | | | @listName [Optional] (a)
| | | | | | | @listVersion [Optional] (a)
| | | | | drop 0-1 (A)
| | | | | | @numberingOrg [Optional] (a)
| | | | | | @codeList [Optional]
| | | | | | @listName [Optional] (a)
| | | | | | @listVersion [Optional] (a)
| | | | | size 0-1 (A)
| | | | | | @numberingOrg [Optional] (a)
| | | | | | @codeList [Optional]
| | | | | | @listName [Optional] (a)
| | | | | | @listVersion [Optional] (a)
| | | | | artGroup 0-1
| | | | | | @numberingOrg [Optional]
| | | | | | @codeList [Optional]
| | | | | | @listName [Optional]
| | | | | | @listVersion [Optional]
| | | | | added 0-9
| | | | | | @numberingOrg [Optional]
| | | | | | @addType [Optional]
| | | | | description 0-unbounded (AU)
| | | | | | @ln [Optional] (N)
- or -
| | | | | garmentCodeA 1-1 (P)
| | | | | | art 1-1 (U)
| | | | | | | @numberingOrg [Optional]
| | | | | | | @codeList [Optional]
| | | | | | | @listName [Optional]
| | | | | | | @listVersion [Optional]
| | | | | | description 0-unbounded (AU)
| | | | | | | @ln [Optional] (N)
- end choose -
- end choose -
| | | | | lotN 0-99
| | | | | | @numberingOrg [Optional]
| | | | | dyeN 0-99
| | | | | | @numberingOrg [Optional]
| | | | | garConsumption 1-9 (A)
| | | | | | @numberingOrg [Optional]
| | | | | | @consumptionType [Optional] (Na)
| | | | | | | garSizeCode 0-1 (A)
| | | | | | | | @numberingOrg [Optional] (a)
| | | | | | | | @codeList [Optional] (a)
| | | | | | | | @listName [Optional] (a)
| | | | | | | | @listVersion [Optional] (a)
| | | | | qty 1-1

```



```

| | | | | @um [Required]
| | | | | qtyVariance 0-1
| | | | | @um [Optional]
| | | | | @varReason [Optional]
| | | | | mnfrNote 0-99
| | | | | @subject [Optional]
| | | | | image 0-99 (U)
| | | | | @subject [Optional]
| | | | | progress 0-9 (P)
| | | | | qty 1-2 (p)
| | | | | @um [Required]
| | | | | deliveryDate 0-1
| | | | | @dateForm [Optional]
| | | | | delGrantedDate 0-1
| | | | | @dateForm [Optional]
| | | | | - choose -
| | | | | | mfrStatus 0-1
| | | | | - or -
| | | | | | mfrStatusText 0-1 (U)
| | | | | - end choose -
| | | | | itemsList 0-1 (N)
| | | | | | qualityLevel 0-1 (N)
| | | | | | | @numberingOrg [Optional] (a)
| | | | | | | @codeList [Optional] (a)
| | | | | | | @listName [Optional] (a)
| | | | | | | @listVersion [Optional] (a)
| | | | | | itemIdentification 1-unbounded (N)
| | | | | | | serialN 1-9 (AU)
| | | | | | | @numberingOrg [Optional]
| | | | | | | @idQualifier [Optional] (N)
| | | | | | qualityLevel 0-1 (N)
| | | | | | | @numberingOrg [Optional]
| | | | | | | @codeList [Optional]
| | | | | | | @listName [Optional]
| | | | | | | @listVersion [Optional]
| | | | | | statusReason 0-1 (N)
| | | | | apparelComponent 0-9
| | | | | | gPart 0-1
| | | | | | yarnComponent 0-9 (P)
| | | | | | | @CQQ [Optional]
| | | | | | | pcQty 0-1
| | | | | | | @um [Optional]
| | | | | | | yarnCode 1-1 (P)
| | | | | | | | @numberingOrg [Optional] [Default= CL]
| | | | | | | | | art 1-1 (U)
| | | | | | | | | @numberingOrg [Optional]
| | | | | | | | | @codeList [Optional]
| | | | | | | | | @listName [Optional]
| | | | | | | | | @listVersion [Optional]
| | | | | | | | color 0-1
| | | | | | | | | @numberingOrg [Optional]
| | | | | | | | | @codeList [Optional]
| | | | | | | | | @listName [Optional]
| | | | | | | | | @listVersion [Optional]
| | | | | | | | added 0-9
| | | | | | | | | @numberingOrg [Optional]
| | | | | | | | | @addType [Optional]
| | | | | | | | description 0-unbounded (AU)
| | | | | | | | | @ln [Optional] (N)
| | | | | | | lotN 0-1
| | | | | | | | @numberingOrg [Optional]

```

dyeN 0-1  
 | @numberingOrg [Optional]  
 qty 1-2  
 | @um [Required]  
**refDoc 0-9 (P)**  
 | @docType [Required]  
 | docID 1-2 (p)  
 | | @numberingOrg [Optional]  
 | docDate 0-1  
 | | @dateForm [Optional]  
 | season 0-1 (A)  
 | | @numberingOrg [Optional] (a)  
 | | @codeList [Optional] (a)  
 | | @listName [Optional] (a)  
 | | @listVersion [Optional] (a)  
 | itemID 0-1 (U)  
**attachment 0-1 (N)**  
 | @uid [Optional]  
 | | fileName 0-1 (N)  
 | | | @numberingOrg [Optional] (a)  
 | | binaryObject 0-1 (N)  
 | | | @format [Optional] (Na)  
 | | | @mime [Optional] (Na)  
 | | | @encoding [Optional] (Na)  
 | | | @characterSet [Optional] (Na)  
 | | **externalReference 0-99 (N)**  
 | | | uri 1-1 (N)  
 | | | | @isURL [Optional] [Default= true] (Na)  
 | | | | mimeTypeCode 0-1 (N)  
 | | | | formatCode 0-1 (N)  
 | | | | encodingCode 0-1 (N)  
 | | | | characterSetCode 0-1 (N)  
 location 0-1  
 | @LRI [Optional]  
 warpLetter 0-1  
 weftLetter 0-1  
 note 0-99  
 | @numberingOrg [Optional]  
 | @codeList [Optional]  
 | @noteLabel [Optional]  
**fabricComponent 0-9 (P)**  
**texCode 1-1 (P)**  
 | @numberingOrg [Optional]  
 | | art 1-1 (U)  
 | | | @numberingOrg [Optional]  
 | | | @codeList [Optional]  
 | | | @listName [Optional]  
 | | | @listVersion [Optional]  
 | pattern 0-1  
 | | @numberingOrg [Optional]  
 | | @codeList [Optional]  
 | | @listName [Optional]  
 | | @listVersion [Optional]  
 | color 0-1  
 | | @numberingOrg [Optional]  
 | | @codeList [Optional]  
 | | @listName [Optional]  
 | | @listVersion [Optional]  
 | added 0-9  
 | | @numberingOrg [Optional]  
 | | @addType [Optional]

```

| | | | | description 0-unbounded (pAU)
| | | | | @ln [Optional] (N)
| | | | | qty 1-3
| | | | | @um [Required]
| | | | | - choose -
| | | | | serialN 0-unbounded (AU)
| | | | | @numberingOrg [Optional]
| | | | | @idQualifier [Optional] (N)
| | | | | - or -
| | | | | itemsList 0-unbounded (N)
| | | | | | qualityLevel 0-1 (N)
| | | | | | @numberingOrg [Optional] (a)
| | | | | | @codeList [Optional] (a)
| | | | | | @listName [Optional] (a)
| | | | | | @listVersion [Optional] (a)
| | | | | | itemIdentification 1-unbounded (N)
| | | | | | | serialN 1-9 (AU)
| | | | | | | @numberingOrg [Optional]
| | | | | | | @idQualifier [Optional] (N)
| | | | | - end choose -
| | | | | refDoc 0-9 (P)
| | | | | | @docType [Required]
| | | | | | docID 1-2 (p)
| | | | | | | @numberingOrg [Optional]
| | | | | | docDate 0-1
| | | | | | | @dateForm [Optional]
| | | | | | season 0-1 (A)
| | | | | | | @numberingOrg [Optional] (a)
| | | | | | | @codeList [Optional] (a)
| | | | | | | @listName [Optional] (a)
| | | | | | | @listVersion [Optional] (a)
| | | | | | itemID 0-1 (U)
| | | | | | attachment 0-1 (N)
| | | | | | | @uid [Optional]
| | | | | | | | fileName 0-1 (N)
| | | | | | | | @numberingOrg [Optional] (a)
| | | | | | | | binaryObject 0-1 (N)
| | | | | | | | @format [Optional] (Na)
| | | | | | | | @mime [Optional] (Na)
| | | | | | | | @encoding [Optional] (Na)
| | | | | | | | @characterSet [Optional] (Na)
| | | | | | | externalReference 0-99 (N)
| | | | | | | | uri 1-1 (N)
| | | | | | | | | @isURL [Optional] [Default= true] (Na)
| | | | | | | | | mimeTypeCode 0-1 (N)
| | | | | | | | | formatCode 0-1 (N)
| | | | | | | | | encodingCode 0-1 (N)
| | | | | | | | | characterSetCode 0-1 (N)
| | | | | | location 0-1
| | | | | | | @LRI [Optional]
| | | | | | note 0-99
| | | | | | | @numberingOrg [Optional]
| | | | | | | @codeList [Optional]
| | | | | | | @noteLabel [Optional]
| | | | | garmentPartComponent 0-9 (P)
| | | | | | garmentPartCode 1-1 (P)
| | | | | | | @numberingOrg [Optional]
| | | | | | | | gPart 1-1
| | | | | | | | mod 1-1
| | | | | | | | @numberingOrg [Optional]
| | | | | | | | @codeList [Optional]

```

```

| @listName [Optional]
| @listVersion [Optional]
fabric 0-1
| @numberingOrg [Optional]
| @codeList [Optional]
| @listName [Optional]
| @listVersion [Optional]
color 0-1
| @numberingOrg [Optional]
| @codeList [Optional]
| @listName [Optional]
| @listVersion [Optional]
added 0-19
| @numberingOrg [Optional]
| @addType [Optional]
size 0-1 (A)
| @numberingOrg [Optional] (a)
| @codeList [Optional]
| @listName [Optional] (a)
| @listVersion [Optional] (a)
description 0-unbounded (AU)
| @ln [Optional] (N)
lotN 0-1
| @numberingOrg [Optional]
dyeN 0-1
| @numberingOrg [Optional]
qty 1-2
| @um [Required]
refDoc 0-9 (P)
| @docType [Required]
| docID 1-2 (p)
| @numberingOrg [Optional]
docDate 0-1
| @dateForm [Optional]
season 0-1 (A)
| @numberingOrg [Optional] (a)
| @codeList [Optional] (a)
| @listName [Optional] (a)
| @listVersion [Optional] (a)
itemID 0-1 (U)
| attachment 0-1 (N)
| @uid [Optional]
| fileName 0-1 (N)
| @numberingOrg [Optional] (a)
| binaryObject 0-1 (N)
| @format [Optional] (Na)
| @mime [Optional] (Na)
| @encoding [Optional] (Na)
| @characterSet [Optional] (Na)
| externalReference 0-99 (N)
| uri 1-1 (N)
| @isURL [Optional] [Default= true] (Na)
| mimeTypeCode 0-1 (N)
| formatCode 0-1 (N)
| encodingCode 0-1 (N)
| characterSetCode 0-1 (N)
location 0-1
| @LRI [Optional]
note 0-99
| @numberingOrg [Optional]
| @codeList [Optional]

```

```

| @noteLabel [Optional]
| acsComponent 0-99 (P)
|   acsCode 1-1 (U)
|     @numberingOrg [Optional]
|       art 1-1 (U)
|         @numberingOrg [Optional]
|         @codeList [Optional]
|         @listName [Optional]
|         @listVersion [Optional]
|       pattern 0-1
|         @numberingOrg [Optional]
|         @codeList [Optional]
|         @listName [Optional]
|         @listVersion [Optional]
|       color 0-1
|         @numberingOrg [Optional]
|         @codeList [Optional]
|         @listName [Optional]
|         @listVersion [Optional]
|       added 0-9
|         @numberingOrg [Optional]
|         @addType [Optional]
|       description 0-unbounded (AU)
|         @ln [Optional] (N)
|     lotN 0-1
|       @numberingOrg [Optional]
|     dyeN 0-1
|       @numberingOrg [Optional]
|     qty 1-2
|       @um [Required]
|     refDoc 0-9 (P)
|       @docType [Required]
|         docID 1-2 (p)
|           @numberingOrg [Optional]
|         docDate 0-1
|           @dateForm [Optional]
|         season 0-1 (A)
|           @numberingOrg [Optional] (a)
|           @codeList [Optional] (a)
|           @listName [Optional] (a)
|           @listVersion [Optional] (a)
|         itemID 0-1 (U)
|       attachment 0-1 (N)
|         @uid [Optional]
|           fileName 0-1 (N)
|             @numberingOrg [Optional] (a)
|           binaryObject 0-1 (N)
|             @format [Optional] (Na)
|             @mime [Optional] (Na)
|             @encoding [Optional] (Na)
|             @characterSet [Optional] (Na)
|           externalReference 0-99 (N)
|             uri 1-1 (N)
|               @isURL [Optional] [Default= true] (Na)
|             mimeTypeCode 0-1 (N)
|             formatCode 0-1 (N)
|             encodingCode 0-1 (N)
|             characterSetCode 0-1 (N)
|     location 0-1
|       @LRI [Optional]
|     note 0-99

```

```

| | | | @numberingOrg [Optional]
| | | | @codeList [Optional]
| | | | @noteLabel [Optional]
| | | appMnfrOperation 0-9 (P)
| | | - choose -
| | | | jobName 1-1
| | | - or -
| | | | appJob 1-1
| | | - end choose -
| | | | appJobTech 0-1
| | | | refDoc 0-9 (P)
| | | | @docType [Required]
| | | | | docID 1-2
| | | | | @numberingOrg [Optional]
| | | | | docDate 0-1
| | | | | @dateForm [Optional]
| | | | | season 0-1 (A)
| | | | | @numberingOrg [Optional] (a)
| | | | | @codeList [Optional] (a)
| | | | | @listName [Optional] (a)
| | | | | @listVersion [Optional] (a)
| | | | | itemID 0-1 (U)
| | | | | attachment 0-1 (N)
| | | | | | @uid [Optional]
| | | | | | | fileName 0-1 (N)
| | | | | | | @numberingOrg [Optional] (a)
| | | | | | | binaryObject 0-1 (N)
| | | | | | | @format [Optional] (Na)
| | | | | | | @mime [Optional] (Na)
| | | | | | | @encoding [Optional] (Na)
| | | | | | | @characterSet [Optional] (Na)
| | | | | | | externalReference 0-99 (N)
| | | | | | | | uri 1-1 (N)
| | | | | | | | @isURL [Optional] [Default= true] (Na)
| | | | | | | | mimeTypeCode 0-1 (N)
| | | | | | | | formatCode 0-1 (N)
| | | | | | | | encodingCode 0-1 (N)
| | | | | | | | characterSetCode 0-1 (N)
| | | | appMachine 0-1
| | | | note 0-99
| | | | @numberingOrg [Optional]
| | | | @codeList [Optional]
| | | | @noteLabel [Optional]
| | | phase 0-99 (N)
| | | @progr [Required] (Na)
| | | | phaseCode 1-1 (N)
| | | | @numberingOrg [Optional] (a)
| | | | @codeList [Optional] (a)
| | | | @listName [Optional] (a)
| | | | @listVersion [Optional] (a)
| | | | criticalityIndicator 0-1 (N)
| | | | finalIndicator 0-1 (N)
| | | | qty 0-2
| | | | @um [Required]
| | | | lotDetails 0-99 (N)
| | | | | lotN 1-1
| | | | | @numberingOrg [Optional]
| | | | | qty 0-1
| | | | | @um [Required]
| | | | | csRange 0-99 (P)
| | | | | @numberingOrg [Optional]

```

```

| @sizeSystemNat [Optional]
| @sizeSystemSeg [Optional]
| @sizeSystemBase [Optional]
| @sizeSystemID [Optional]
| color 0-1
| @numberingOrg [Optional]
| @codeList [Optional]
| @listName [Optional]
| @listVersion [Optional]
| garmentVariant 0-9 (N)
| | variantType 1-1 (N)
| | | @numberingOrg [Optional] (a)
| | | @codeList [Optional] (a)
| | | @listName [Optional] (a)
| | | @listVersion [Optional] (a)
| | variantCode 1-1 (N)
| | | @numberingOrg [Optional] (a)
| | | @codeList [Optional] (a)
| | | @listName [Optional] (a)
| | | @listVersion [Optional] (a)
| drop 0-1 (A)
| @numberingOrg [Optional] (a)
| @codeList [Optional]
| @listName [Optional] (a)
| @listVersion [Optional] (a)
| sizeMatrix 1-1
| | sizeRow 1-99 (P)
| | | additionalComponentCode 0-9 (N)
| | | | @numberingOrg [Optional] (a)
| | | | @codeList [Optional] (a)
| | | | @listName [Optional] (a)
| | | | @listVersion [Optional] (a)
| | | drop 0-1 (A)
| | | | @numberingOrg [Optional] (a)
| | | | @codeList [Optional]
| | | | @listName [Optional] (a)
| | | | @listVersion [Optional] (a)
| | | size 1-1 (A)
| | | | @numberingOrg [Optional] (a)
| | | | @codeList [Optional]
| | | | @listName [Optional] (a)
| | | | @listVersion [Optional] (a)
| | | qty 0-1
| | | | @um [Required]
| | | itemsList 0-1 (N)
| | | | qualityLevel 0-1 (N)
| | | | | @numberingOrg [Optional] (a)
| | | | | @codeList [Optional] (a)
| | | | | @listName [Optional] (a)
| | | | | @listVersion [Optional] (a)
| | | itemIdentification 1-unbounded (N)
| | | | serialN 1-9 (AU)
| | | | | @numberingOrg [Optional]
| | | | | @idQualifier [Optional] (N)
| refDoc 0-99 (P)
| @docType [Required]
| | docID 1-2 (p)
| | | @numberingOrg [Optional]
| | docDate 0-1
| | | @dateForm [Optional]
| | season 0-1 (A)

```

```

| | | | @numberingOrg [Optional]
| | | | @codeList [Optional]
| | | | @listName [Optional]
| | | | @listVersion [Optional]
| | | | itemID 0-1 (U)
| | | | attachment 0-1 (N)
| | | | | @uid [Optional]
| | | | | | fileName 0-1 (N)
| | | | | | @numberingOrg [Optional] (a)
| | | | | | binaryObject 0-1 (N)
| | | | | | @format [Optional] (Na)
| | | | | | @mime [Optional] (Na)
| | | | | | @encoding [Optional] (Na)
| | | | | | @characterSet [Optional] (Na)
| | | | | externalReference 0-99 (N)
| | | | | | uri 1-1 (N)
| | | | | | | @isURL [Optional] [Default= true] (Na)
| | | | | | | mimeTypeCode 0-1 (N)
| | | | | | | formatCode 0-1 (N)
| | | | | | | encodingCode 0-1 (N)
| | | | | | | characterSetCode 0-1 (N)
| | | | notBeforeDate 0-1 (p)
| | | | | @dateForm [Optional]
| | | | | deliveryDate 0-1
| | | | | | @dateForm [Optional]
| | | | | delGrantedDate 0-1 (p)
| | | | | | @dateForm [Optional]
| | | | | price 0-1 (AU)
| | | | | | @um [Optional]
| | | | | | @priceQualifier [Optional] [Default= NET]
| | | | | | @currency [Optional] (a)
| | | | | thirdParty 0-9 (AP)
| | | | | | @VAT [Optional]
| | | | | | @role [Required]
| | | | | | @sender [Optional] (a*)
| | | | | | | id 1-1
| | | | | | | @numberingOrg [Optional]
| | | | | | | legalName 0-1 (U)
| | | | | | | dept 0-1
| | | | | | | subDept 0-1 (N)
| | | | | | | person 0-1
| | | | | | | | @email [Optional]
| | | | | | | | @phone [Optional]
| | | | | | | | @fax [Optional]
| | | | | | | street 0-1
| | | | | | | city 0-1
| | | | | | | subCountry 0-1
| | | | | | | country 0-1
| | | | | | | postCode 0-1
| | | | | garConsumptionSet 0-99 (Pp)
| | | | | - choose -
| | | | | | acsCode 1-1 (U)
| | | | | | | @numberingOrg [Optional]
| | | | | | | | art 1-1 (U)
| | | | | | | | @numberingOrg [Optional]
| | | | | | | | @codeList [Optional]
| | | | | | | | @listName [Optional]
| | | | | | | | @listVersion [Optional]
| | | | | | | pattern 0-1
| | | | | | | @numberingOrg [Optional]
| | | | | | | @codeList [Optional]

```



| | | | | @listName [Optional]  
 | | | | | @listVersion [Optional]  
 | | | | | color 0-1  
 | | | | | @numberingOrg [Optional]  
 | | | | | @codeList [Optional]  
 | | | | | @listName [Optional]  
 | | | | | @listVersion [Optional]  
 | | | | | added 0-9  
 | | | | | @numberingOrg [Optional]  
 | | | | | @addType [Optional]  
 | | | | | description 0-unbounded (AU)  
 | | | | | @ln [Optional] (N)

- or -

| | | | | **texCode 1-1** (P)  
 | | | | | @numberingOrg [Optional]  
 | | | | | art 1-1 (U)  
 | | | | | @numberingOrg [Optional]  
 | | | | | @codeList [Optional]  
 | | | | | @listName [Optional]  
 | | | | | @listVersion [Optional]  
 | | | | | pattern 0-1  
 | | | | | @numberingOrg [Optional]  
 | | | | | @codeList [Optional]  
 | | | | | @listName [Optional]  
 | | | | | @listVersion [Optional]  
 | | | | | color 0-1  
 | | | | | @numberingOrg [Optional]  
 | | | | | @codeList [Optional]  
 | | | | | @listName [Optional]  
 | | | | | @listVersion [Optional]  
 | | | | | added 0-9  
 | | | | | @numberingOrg [Optional]  
 | | | | | @addType [Optional]  
 | | | | | description 0-unbounded (pAU)  
 | | | | | @ln [Optional] (N)

- or -

| | | | | **yarnCode 1-1** (P)  
 | | | | | @numberingOrg [Optional] [Default= CL]  
 | | | | | art 1-1 (U)  
 | | | | | @numberingOrg [Optional]  
 | | | | | @codeList [Optional]  
 | | | | | @listName [Optional]  
 | | | | | @listVersion [Optional]  
 | | | | | color 0-1  
 | | | | | @numberingOrg [Optional]  
 | | | | | @codeList [Optional]  
 | | | | | @listName [Optional]  
 | | | | | @listVersion [Optional]  
 | | | | | added 0-9  
 | | | | | @numberingOrg [Optional]  
 | | | | | @addType [Optional]  
 | | | | | description 0-unbounded (AU)  
 | | | | | @ln [Optional] (N)

- or -

| | | | | **garmentPartCode 1-1** (P)  
 | | | | | @numberingOrg [Optional]  
 | | | | | gPart 1-1  
 | | | | | mod 1-1  
 | | | | | @numberingOrg [Optional]  
 | | | | | @codeList [Optional]  
 | | | | | @listName [Optional]

```

| | | | @listVersion [Optional]
| | | | fabric 0-1
| | | | @numberingOrg [Optional]
| | | | @codeList [Optional]
| | | | @listName [Optional]
| | | | @listVersion [Optional]
| | | | color 0-1
| | | | @numberingOrg [Optional]
| | | | @codeList [Optional]
| | | | @listName [Optional]
| | | | @listVersion [Optional]
| | | | added 0-19
| | | | @numberingOrg [Optional]
| | | | @addType [Optional]
| | | | size 0-1 (A)
| | | | @numberingOrg [Optional] (a)
| | | | @codeList [Optional]
| | | | @listName [Optional] (a)
| | | | @listVersion [Optional] (a)
| | | | description 0-unbounded (AU)
| | | | @ln [Optional] (N)

```

- or -

```

| | | | garmentCode 1-1
| | | | @numberingOrg [Optional]

```

- choose -

```

| | | | garmentCodeB 1-1 (P)
| | | | @numberingOrg [Optional]
| | | | mod 1-1
| | | | @numberingOrg [Optional]
| | | | @codeList [Optional]
| | | | @listName [Optional]
| | | | @listVersion [Optional]
| | | | fabric 0-1
| | | | @numberingOrg [Optional]
| | | | @codeList [Optional]
| | | | @listName [Optional]
| | | | @listVersion [Optional]
| | | | color 0-1
| | | | @numberingOrg [Optional]
| | | | @codeList [Optional]
| | | | @listName [Optional]
| | | | @listVersion [Optional]
| | | | garmentVariant 0-9 (N)
| | | | variantType 1-1 (N)
| | | | @numberingOrg [Optional] (a)
| | | | @codeList [Optional] (a)
| | | | @listName [Optional] (a)
| | | | @listVersion [Optional] (a)
| | | | variantCode 1-1 (N)
| | | | @numberingOrg [Optional] (a)
| | | | @codeList [Optional] (a)
| | | | @listName [Optional] (a)
| | | | @listVersion [Optional] (a)
| | | | drop 0-1 (A)
| | | | @numberingOrg [Optional] (a)
| | | | @codeList [Optional]
| | | | @listName [Optional] (a)
| | | | @listVersion [Optional] (a)
| | | | size 0-1 (A)
| | | | @numberingOrg [Optional] (a)
| | | | @codeList [Optional]

```

```

| | | | | @listName [Optional] (a)
| | | | | @listVersion [Optional] (a)
| | | | | artGroup 0-1
| | | | | @numberingOrg [Optional]
| | | | | @codeList [Optional]
| | | | | @listName [Optional]
| | | | | @listVersion [Optional]
| | | | | added 0-9
| | | | | @numberingOrg [Optional]
| | | | | @addType [Optional]
| | | | | description 0-unbounded (AU)
| | | | | @ln [Optional] (N)
- or -
| | | | | garmentCodeA 1-1 (P)
| | | | | art 1-1 (U)
| | | | | @numberingOrg [Optional]
| | | | | @codeList [Optional]
| | | | | @listName [Optional]
| | | | | @listVersion [Optional]
| | | | | description 0-unbounded (AU)
| | | | | @ln [Optional] (N)
- end choose -
- end choose -
| | | | | lotN 0-99
| | | | | @numberingOrg [Optional]
| | | | | dyeN 0-99
| | | | | @numberingOrg [Optional]
| | | | | garConsumption 1-9 (A)
| | | | | @numberingOrg [Optional]
| | | | | @consumptionType [Optional] (Na)
| | | | | garSizeCode 0-1 (A)
| | | | | @numberingOrg [Optional] (a)
| | | | | @codeList [Optional] (a)
| | | | | @listName [Optional] (a)
| | | | | @listVersion [Optional] (a)
| | | | | qty 1-1
| | | | | @um [Required]
| | | | | qtyVariance 0-1
| | | | | @um [Optional]
| | | | | @varReason [Optional]
| | | | | packages 0-99 (P)
| | | | | @packageLevel [Optional]
- choose -
| | | | | packageText 1-1 (U)
- or -
| | | | | package 1-1
- end choose -
| | | | | packageModelCode 0-1 (N)
| | | | | @numberingOrg [Optional]
| | | | | description 0-unbounded (AU)
| | | | | @ln [Optional] (N)
| | | | | packageDim 0-1
| | | | | length 1-1
| | | | | @um [Required]
| | | | | width 0-1
| | | | | @um [Required]
| | | | | height 0-1
| | | | | @um [Required]
| | | | | handlingChar 0-1 (N)
- choose -
| | | | | yarnPack 0-1

```

```

| | | | | | | | yarnReel 1-1
| | | | | | | | @reelType [Required]
| | | | | | | | @reelMat [Optional]
| | | | | | | | | yarnReelD 0-1
| | | | | | | | | @um [Required]
| | | | | | | | | yarnReelH 0-1
| | | | | | | | | @um [Required]
| | | | | | | | | yarnConeAngle 0-1
| | | | | | | | | yarnReelQty 0-2
| | | | | | | | | @um [Required]
| | | | | | | | | label 0-1
| | | | | | | | | labelWrit 0-1
| | | | | | | | yarnInWrap 0-1
| | | | | | | | | yarnReelWrap 1-1
| | | | | | | | | label 0-1
| | | | | | | | | labelWrit 0-1
| | | | | | | | - choose -
| | | | | | | | | yarnOutWrapText 0-1 (U)
| | | | | | | | - or -
| | | | | | | | | yarnOutWrap 0-1
| | | | | | | | - end choose -
| | | | | | | | - or -
| | | | | | | | | piecePack 0-1
| | | | | | | | - choose -
| | | | | | | | | piecePackText 1-1 (U)
| | | | | | | | - or -
| | | | | | | | | pieceInnWrap1 1-1
| | | | | | | | | pieceInnWrap2 0-1
| | | | | | | | | pieceOutWrap 0-1
| | | | | | | | - end choose -
| | | | | | | | - or -
| | | | | | | | | acsPack 0-1 (U)
| | | | | | | | - choose -
| | | | | | | | | acsPackCode 1-1 (AU)
| | | | | | | | | @numberingOrg [Optional] (a)
| | | | | | | | | @codeList [Optional] (a)
| | | | | | | | | @listName [Optional] (a)
| | | | | | | | | @listVersion [Optional] (a)
| | | | | | | | - or -
| | | | | | | | | acsPackText 1-1 (U)
| | | | | | | | - end choose -
| | | | | | | | - or -
| | | | | | | | | garPack 0-1 (N)
| | | | | | | | - choose -
| | | | | | | | | garPackCode 1-1 (N)
| | | | | | | | | @numberingOrg [Optional] (a)
| | | | | | | | | @codeList [Optional] (a)
| | | | | | | | | @listName [Optional] (a)
| | | | | | | | | @listVersion [Optional] (a)
| | | | | | | | - or -
| | | | | | | | | garPackText 1-1 (N)
| | | | | | | | - end choose -
| | | | | | | | - end choose -
| | | | | | | | | sortableIndicator 0-1 (N)
| | | | | | | | | stackabilityLevel 0-1 (N)
| | | | | | | | | handlingType 0-1 (N)
| | | | | | | | | @ln [Optional] (Na)
| | | | | | | | | volume 0-1
| | | | | | | | | @um [Required]
| | | | | | | | | netWeight 0-1
| | | | | | | | | @um [Required]

```

grossWeight 0-1  
   @um [Required]  
 note 0-99  
   @numberingOrg [Optional]  
   @codeList [Optional]  
   @noteLabel [Optional]

itemsPerPackage 0-1 (N)  
   @um [Required]

minItemsPerPackage 0-1 (N)  
   @um [Required]

fillingCriterion 0-9 (N)  
   @progr [Optional] (N)

packageQty 0-1  
 packageN 0-unbounded (U)  
   @numberingOrg [Optional]  
   @packageContainerN [Optional]

**EPClist 0-1**  
   EPC 1-unbounded  
   @numberingOrg [Optional]  
   @TID [Optional]

note 0-99  
   @numberingOrg [Optional]  
   @codeList [Optional]  
   @noteLabel [Optional]

**garComInfo 0-1 (N\*)**  
 @endUse [Optional] (a)

season 0-1 (A)  
   @numberingOrg [Optional] (a)  
   @codeList [Optional] (a)  
   @listName [Optional] (a)  
   @listVersion [Optional] (a)

brand 0-1 (N)  
   @numberingOrg [Optional] (a)  
   @codeList [Optional] (a)  
   @listName [Optional] (a)  
   @listVersion [Optional] (a)

productLine 0-1 (N)  
   @numberingOrg [Optional]  
   @codeList [Optional]  
   @listName [Optional]  
   @listVersion [Optional]

project 0-1 (U)

operationalCode 0-19 (N)  
   @numberingOrg [Optional]  
   @codeList [Optional]  
   @listName [Optional]  
   @listVersion [Optional]  
   @codeQualifier [Optional] (N)

deliveryDate 0-1 (p)  
   @dateForm [Optional]

specDate 0-1 (p)  
   @dateForm [Optional]

- choose -

**yarnPack 0-1 (p)**  
   **yarnReel 1-1**  
     @reelType [Required]  
     @reelMat [Optional]

    yarnReelD 0-1  
       @um [Required]

    yarnReelH 0-1  
       @um [Required]

```

| | | | | yarnConeAngle 0-1
| | | | | yarnReelQty 0-2
| | | | |   @um [Required]
| | | | | label 0-1
| | | | | labelWrit 0-1
| | | | | | yarnInWrap 0-1
| | | | | |   yarnReelWrap 1-1
| | | | | |   label 0-1
| | | | | |   labelWrit 0-1
| | | | | - choose -
| | | | | | yarnOutWrapText 0-1 (U)
| | | | | - or -
| | | | | | yarnOutWrap 0-1
| | | | | - end choose -
| | | | | - or -
| | | | | | piecePack 0-1 (p)
| | | | | - choose -
| | | | | | piecePackText 1-1 (U)
| | | | | - or -
| | | | | | pieceInnWrap1 1-1
| | | | | | pieceInnWrap2 0-1
| | | | | | pieceOutWrap 0-1
| | | | | - end choose -
| | | | | - or -
| | | | | | acsPack 0-1 (U)
| | | | | - choose -
| | | | | | acsPackCode 1-1 (AU)
| | | | | |   @numberingOrg [Optional] (a)
| | | | | |   @codeList [Optional] (a)
| | | | | |   @listName [Optional] (a)
| | | | | |   @listVersion [Optional] (a)
| | | | | - or -
| | | | | | acsPackText 1-1 (U)
| | | | | - end choose -
| | | | | - or -
| | | | | | garPack 0-1 (N)
| | | | | - choose -
| | | | | | garPackCode 1-1 (N)
| | | | | |   @numberingOrg [Optional] (a)
| | | | | |   @codeList [Optional] (a)
| | | | | |   @listName [Optional] (a)
| | | | | |   @listVersion [Optional] (a)
| | | | | - or -
| | | | | | garPackText 1-1 (N)
| | | | | - end choose -
| | | | | - end choose -
| | | | | | note 0-99
| | | | | |   @numberingOrg [Optional]
| | | | | |   @codeList [Optional]
| | | | | |   @noteLabel [Optional]
| | | | | | endUseGroup 0-99 (N)
| | | | | |   endUseGroupID 1-1 (N)
| | | | | |   qty 0-1
| | | | | |   @um [Required]
| | | | | | | csRange 0-1 (P)
| | | | | | |   @numberingOrg [Optional]
| | | | | | |   @sizeSystemNat [Optional]
| | | | | | |   @sizeSystemSeg [Optional]
| | | | | | |   @sizeSystemBase [Optional]
| | | | | | |   @sizeSystemID [Optional]
| | | | | | |   color 0-1

```

```

| | | | @numberingOrg [Optional]
| | | | @codeList [Optional]
| | | | @listName [Optional]
| | | | @listVersion [Optional]
| | | | garmentVariant 0-9 (N)
| | | | | variantType 1-1 (N)
| | | | | | @numberingOrg [Optional] (a)
| | | | | | @codeList [Optional] (a)
| | | | | | @listName [Optional] (a)
| | | | | | @listVersion [Optional] (a)
| | | | | variantCode 1-1 (N)
| | | | | | @numberingOrg [Optional] (a)
| | | | | | @codeList [Optional] (a)
| | | | | | @listName [Optional] (a)
| | | | | | @listVersion [Optional] (a)
| | | | drop 0-1 (A)
| | | | | @numberingOrg [Optional] (a)
| | | | | @codeList [Optional]
| | | | | @listName [Optional] (a)
| | | | | @listVersion [Optional] (a)
| | | | sizeMatrix 1-1
| | | | | sizeRow 1-99 (P)
| | | | | | additionalComponentCode 0-9 (N)
| | | | | | | @numberingOrg [Optional] (a)
| | | | | | | @codeList [Optional] (a)
| | | | | | | @listName [Optional] (a)
| | | | | | | @listVersion [Optional] (a)
| | | | | | drop 0-1 (A)
| | | | | | | @numberingOrg [Optional] (a)
| | | | | | | @codeList [Optional]
| | | | | | | @listName [Optional] (a)
| | | | | | | @listVersion [Optional] (a)
| | | | | | size 1-1 (A)
| | | | | | | @numberingOrg [Optional] (a)
| | | | | | | @codeList [Optional]
| | | | | | | @listName [Optional] (a)
| | | | | | | @listVersion [Optional] (a)
| | | | | | qty 0-1
| | | | | | | @um [Required]
| | | | | | itemsList 0-1 (N)
| | | | | | | qualityLevel 0-1 (N)
| | | | | | | | @numberingOrg [Optional] (a)
| | | | | | | | @codeList [Optional] (a)
| | | | | | | | @listName [Optional] (a)
| | | | | | | | @listVersion [Optional] (a)
| | | | | | | itemIdentification 1-unbounded (N)
| | | | | | | | serialN 1-9 (AU)
| | | | | | | | | @numberingOrg [Optional]
| | | | | | | | | @idQualifier [Optional] (N)
| | | | packages 0-99 (Pp)
| | | | | @packageLevel [Optional]
| | | | - choose -
| | | | | packageText 1-1 (U)
| | | | - or -
| | | | | package 1-1
| | | | - end choose -
| | | | | packageModelCode 0-1 (N)
| | | | | | @numberingOrg [Optional]
| | | | | description 0-unbounded (AU)
| | | | | | @ln [Optional] (N)
| | | | | packageDim 0-1

```

```

| | | | | length 1-1
| | | | | @um [Required]
| | | | | width 0-1
| | | | | @um [Required]
| | | | | height 0-1
| | | | | @um [Required]
| | | | | handlingChar 0-1 (N)
- choose -
| | | | | yarnPack 0-1
| | | | | | yarnReel 1-1
| | | | | | | @reelType [Required]
| | | | | | | @reelMat [Optional]
| | | | | | | | yarnReelID 0-1
| | | | | | | | @um [Required]
| | | | | | | | yarnReelH 0-1
| | | | | | | | @um [Required]
| | | | | | | | yarnConeAngle 0-1
| | | | | | | | yarnReelQty 0-2
| | | | | | | | @um [Required]
| | | | | | | | label 0-1
| | | | | | | | labelWrit 0-1
| | | | | | | yarnInWrap 0-1
| | | | | | | | yarnReelWrap 1-1
| | | | | | | | label 0-1
| | | | | | | | labelWrit 0-1
- choose -
| | | | | | | yarnOutWrapText 0-1 (U)
- or -
| | | | | | | yarnOutWrap 0-1
- end choose -
- or -
| | | | | | | piecePack 0-1
- choose -
| | | | | | | | piecePackText 1-1 (U)
- or -
| | | | | | | | | pieceInnWrap1 1-1
| | | | | | | | | pieceInnWrap2 0-1
| | | | | | | | | pieceOutWrap 0-1
- end choose -
- or -
| | | | | | | acsPack 0-1 (U)
- choose -
| | | | | | | | | acsPackCode 1-1 (AU)
| | | | | | | | | @numberingOrg [Optional] (a)
| | | | | | | | | @codeList [Optional] (a)
| | | | | | | | | @listName [Optional] (a)
| | | | | | | | | @listVersion [Optional] (a)
- or -
| | | | | | | | | acsPackText 1-1 (U)
- end choose -
- or -
| | | | | | | | garPack 0-1 (N)
- choose -
| | | | | | | | | | garPackCode 1-1 (N)
| | | | | | | | | | @numberingOrg [Optional] (a)
| | | | | | | | | | @codeList [Optional] (a)
| | | | | | | | | | @listName [Optional] (a)
| | | | | | | | | | @listVersion [Optional] (a)
- or -
| | | | | | | | | | garPackText 1-1 (N)
- end choose -

```



- end choose -

| sortableIndicator 0-1 (N)  
| stackabilityLevel 0-1 (N)  
| handlingType 0-1 (N)  
| @In [Optional] (Na)  
| volume 0-1  
| @um [Required]  
| netWeight 0-1  
| @um [Required]  
| grossWeight 0-1  
| @um [Required]  
| note 0-99  
| @numberingOrg [Optional]  
| @codeList [Optional]  
| @noteLabel [Optional]  
| itemsPerPackage 0-1 (N)  
| @um [Required]  
| minItemsPerPackage 0-1 (N)  
| @um [Required]  
| fillingCriterion 0-9 (N)  
| @progr [Optional] (N)  
| packageQty 0-1  
| packageN 0-unbounded (U)  
| @numberingOrg [Optional]  
| @packageContainerN [Optional]  
| **EPCList 0-1**  
| EPC 1-unbounded  
| @numberingOrg [Optional]  
| @TID [Optional]

**dtScheme 0-1 (P)**  
| @taxType [Required]  
| taxCategory 0-1  
| taxRate 0-1  
| legalRef 0-1 (A)  
| @numberingOrg [Optional] (a)  
| @codeList [Optional] (a)  
| @listName [Optional] (a)  
| @listVersion [Optional] (a)  
| note 0-99  
| @numberingOrg [Optional]  
| @codeList [Optional]  
| @noteLabel [Optional]  
| note 0-99  
| @numberingOrg [Optional]  
| @codeList [Optional]  
| @noteLabel [Optional]

## 2.2 Detailed description of document elements

Following tables show all elements (complex and simple) used in this document. Description includes: 1) element's information: xml tag, name, brief description, data type and syntax constraints; 2) information about use of the element in a particular position in the document: xpath and possible associated notes.

### 2.2.1 Complex elements (Aggregate Business Information Entities)

Complex elements are those elements whose content is composed of other elements (childs).Complex elements are alphabetically ordered.

<b>acsCode</b>	full codification identifying an accessory product usually coupled with garment or other fashion product (XPath KnitClothOrder/KCCObody/KCCOitem/phase/garConsumptionSet/acsCode) 1-1 (U) (XPath KnitClothOrder/KCCObody/KCCOitem/garTecSheet/garConsumptionSet/acsCode) 1-1 (U) (XPath KnitClothOrder/KCCObody/KCCOitem/apparelComponent/acsComponent/acsCode) 1-1 (U)
<b>acsComponent</b>	identification details of a accessory used in a sub-contracted manufacturing operation (XPath KnitClothOrder/KCCObody/KCCOitem/apparelComponent/acsComponent) 0-99 (P)
<b>acsPack</b>	type of wrapping or packing of the accessory (XPath KnitClothOrder/KCCObody/KCCOitem/packages/handlingChar/acsPack) 0-1 (U) (XPath KnitClothOrder/KCCObody/KCCOitem/garComInfo/acsPack) 0-1 (U) (XPath KnitClothOrder/KCCObody/KCCOitem/phase/packages/handlingChar/acsPack) 0-1 (U) (XPath KnitClothOrder/garComInfo/acsPack) 0-1 (U)
<b>allowanceCharge</b>	Allowances and Charges related to an Order or a contract (XPath KnitClothOrder/terms/allowanceCharge) 0-9 (A)
<b>apparelComponent</b>	identification details of a component used in the sub-contracted production of an apparel article or of one of its part (XPath KnitClothOrder/KCCObody/KCCOitem/apparelComponent) 0-9
<b>apparelProd</b>	manufacturing specifications for a garment article to be obtained from an operation of sub-contracted production (XPath KnitClothOrder/KCCObody/KCCOitem/apparelProd) 1-1 (P)
<b>appMnfrOperation</b>	details of a manufacturing operation used for garment production (XPath KnitClothOrder/KCCObody/KCCOitem/appMnfrOperation) 0-9 (P)
<b>attachment</b>	an attached document. An attachment can refer to an external document or be included with the document being exchanged (XPath KnitClothOrder/KCCObody/KCCOitem/appMnfrOperation/refDoc/attachment) 0-1 (N) (XPath KnitClothOrder/KCCObody/KCCOitem/phase/refDoc/attachment) 0-1 (N) (XPath KnitClothOrder/KCCObody/KCCOitem/apparelComponent/acsComponent/refDoc/attachment) 0-1 (N) (XPath KnitClothOrder/KCCOheader/refDoc/attachment) 0-1 (N) (XPath KnitClothOrder/KCCObody/KCCOitem/apparelComponent/yarnComponent/refDoc/attachment) 0-1 (N) (XPath KnitClothOrder/KCCObody/KCCOitem/apparelComponent/fabricComponent/refDoc/attachment) 0-1 (N) (XPath KnitClothOrder/KCCObody/KCCOitem/apparelComponent/garmentPartComponent/refDoc/attachment) 0-1 (N) (XPath KnitClothOrder/KCCObody/KCCOitem/garTecSheet/refDoc/attachment) 0-1 (N)

<b>buyer</b>	<p>details of the Buyer (party that buys the good or service that is object of the current collaborative process)</p> <p>- base type: Nad, (XPath KnitClothOrder/KCCOheader/buyer) 1-1 (AP)</p>
<b>csRange</b>	<p>range of color-size for a fashion article</p> <p>(XPath KnitClothOrder/KCCObody/KCCOitem/apparelProd/csRange) 0-99 (P) (XPath KnitClothOrder/KCCObody/KCCOitem/phase/lotDetails/csRange) 0-99 (P) (XPath KnitClothOrder/KCCObody/KCCOitem/endUseGroup/csRange) 0-1 (P)</p>
<b>dtScheme</b>	<p>set of data usable to declare the duty or tax applied</p> <p>(XPath KnitClothOrder/terms/allowanceCharge/dtScheme) 0-1 (P) (XPath KnitClothOrder/KCCObody/KCCOitem/dtScheme) 0-1 (P)</p>
<b>endUseGroup</b>	<p>references that connect the instances of a product to a group of articles (such as a group of items used in a shop window) of which it will be part of.</p> <p>(XPath KnitClothOrder/KCCObody/KCCOitem/endUseGroup) 0-99 (N)</p>
<b>EPCList</b>	<p>list of identifiers used for tracing a physical item with RFID technology</p> <p>(XPath KnitClothOrder/KCCObody/KCCOitem/packages/EPCList) 0-1</p> <p>- note: <i>this element is DEPRECATED, please use the specific elements</i> (XPath KnitClothOrder/KCCObody/KCCOitem/phase/packages/EPCList) 0-1</p> <p>- note: <i>this element is DEPRECATED, please use the specific elements</i></p>
<b>externalReference</b>	<p>details about an external object, such as a document stored at a remote location</p> <p>(XPath KnitClothOrder/KCCObody/KCCOitem/apparelComponent/yarnComponent/refDoc/attachment/externalReference) 0-99 (N) (XPath KnitClothOrder/KCCObody/KCCOitem/apparelComponent/garmentPartComponent/refDoc/attachment/externalReference) 0-99 (N) (XPath KnitClothOrder/KCCObody/KCCOitem/apparelComponent/fabricComponent/refDoc/attachment/externalReference) 0-99 (N) (XPath KnitClothOrder/KCCOheader/refDoc/attachment/externalReference) 0-99 (N) (XPath KnitClothOrder/KCCObody/KCCOitem/phase/refDoc/attachment/externalReference) 0-99 (N) (XPath KnitClothOrder/KCCObody/KCCOitem/appMnfrOperation/refDoc/attachment/externalReference) 0-99 (N) (XPath KnitClothOrder/KCCObody/KCCOitem/apparelComponent/acsComponent/refDoc/attachment/externalReference) 0-99 (N) (XPath KnitClothOrder/KCCObody/KCCOitem/garTecSheet/refDoc/attachment/externalReference) 0-99 (N)</p>
<b>fabricComponent</b>	<p>identification details of a fabric used in a sub-contracted manufacturing operation</p> <p>(XPath KnitClothOrder/KCCObody/KCCOitem/apparelComponent/fabricComponent) 0-9 (P)</p>
<b>fabricCompos</b>	<p>composition of the fabric according to the Directory 97/37/CE</p> <p>(XPath KnitClothOrder/KCCObody/KCCOitem/garTecSheet/fabricCompos) 0-1</p>
<b>garComInfo</b>	<p>miscellaneous commercial information.</p> <p>(XPath KnitClothOrder/KCCObody/KCCOitem/garComInfo) 0-1 (N*)</p> <p>- note: <i>it should be used in this position instead of at document level only if the information apply only to the current line.</i> (XPath KnitClothOrder/garComInfo) 0-1 (N*)</p>
<b>garConsumption</b>	<p>consumption of the component for the given size range</p> <p>(XPath KnitClothOrder/KCCObody/KCCOitem/garTecSheet/garConsumptionSet/garConsumption) 1-9 (A) (XPath KnitClothOrder/KCCObody/KCCOitem/phase/garConsumptionSet/garConsumption) 1-9 (A)</p>
<b>garConsumptionSet</b>	<p>components and average prescribed or effective consumptions for a garment</p> <p>(XPath KnitClothOrder/KCCObody/KCCOitem/phase/garConsumptionSet) 0-99 (Pp) (XPath KnitClothOrder/KCCObody/KCCOitem/garTecSheet/garConsumptionSet) 0-99 (P)</p>

<b>garMea</b>	attribute's measure for the given size (XPath KnitClothOrder/KCCObody/KCCOitem/garTecSheet/ garMeaSet/garMea) 1-9
<b>garMeaSet</b>	physical measures of the set of sizes of a garment (XPath KnitClothOrder/KCCObody/KCCOitem/garTecSheet/garMeaSet) 0-99
<b>garmentCode</b>	codification of the garment product (XPath KnitClothOrder/KCCObody/KCCOitem/garTecSheet/garmentCode) 1-2 (XPath KnitClothOrder/KCCObody/KCCOitem/phase/garConsumptionSet/garmentCode) 1-1 (XPath KnitClothOrder/KCCObody/KCCOitem/apparelProd/garmentCode) 1-2 - note: <i>this element can have two instances only if the numbering organisations are different</i> (XPath KnitClothOrder/KCCObody/KCCOitem/garTecSheet/ garConsumptionSet/garmentCode) 1-1
<b>garmentCodeA</b>	codification of the garment product- type A (XPath KnitClothOrder/KCCObody/KCCOitem/garTecSheet/ garConsumptionSet/garmentCode/garmentCodeA) 1-1 (P) - note: <i>here the barcode EAN-13 or EAN-8 should be specified</i> (XPath KnitClothOrder/KCCObody/KCCOitem/garTecSheet/ garmentCode/garmentCodeA) 1-1 (P) - note: <i>here the barcode EAN-13 or EAN-8 should be specified</i> (XPath KnitClothOrder/KCCObody/KCCOitem/phase/garConsumptionSet/garmentCode/garmentCodeA) 1-1 (P) - note: <i>here the barcode EAN-13 or EAN-8 should be specified</i> (XPath KnitClothOrder/KCCObody/KCCOitem/apparelProd/ garmentCode/garmentCodeA) 1-1 (P) - note: <i>here the barcode EAN-13 or EAN-8 should be specified</i>
<b>garmentCodeB</b>	codification of the garment product - type B (XPath KnitClothOrder/KCCObody/KCCOitem/garTecSheet/ garConsumptionSet/garmentCode/garmentCodeB) 1-1 (P) (XPath KnitClothOrder/KCCObody/KCCOitem/apparelProd/ garmentCode/garmentCodeB) 1-1 (P) (XPath KnitClothOrder/KCCObody/KCCOitem/garTecSheet/ garmentCode/garmentCodeB) 1-1 (P) (XPath KnitClothOrder/KCCObody/KCCOitem/phase/garConsumptionSet/garmentCode/garmentCodeB) 1-1 (P)
<b>garmentPartCode</b>	codification of the component or part of a fashion article (XPath KnitClothOrder/KCCObody/KCCOitem/phase/garConsumptionSet/garmentPartCode) 1-1 (P) (XPath KnitClothOrder/KCCObody/KCCOitem/apparelComponent/ garmentPartComponent/garmentPartCode) 1-1 (P) (XPath KnitClothOrder/KCCObody/KCCOitem/apparelProd/garmentPartCode) 1-2 (P) - note: <i>this element can have two instances only if the numbering organisations are different</i> (XPath KnitClothOrder/KCCObody/KCCOitem/garTecSheet/ garConsumptionSet/garmentPartCode) 1-1 (P)
<b>garmentPartComponent</b>	identification details of a FASHION product part used in a sub-contracted manufacturing operation (XPath KnitClothOrder/KCCObody/KCCOitem/apparelComponent/garmentPartComponent) 0-9 (P) - note: <i>used only for components that are semifinished products with their own code</i>
<b>garmentVariant</b>	garment product variant (XPath KnitClothOrder/KCCObody/KCCOitem/phase/lotDetails/ csRange/garmentVariant) 0-9 (N)

	<p>- note: <i>used only if not already specified in the article code</i> (XPath KnitClothOrder/KCCObody/KCCOitem/phase/garConsumptionSet/garmentCode/garmentCodeB/garmentVariant) 0-9 (N) (XPath KnitClothOrder/KCCObody/KCCOitem/garTecSheet/garConsumptionSet/garmentCode/garmentCodeB/garmentVariant) 0-9 (N) (XPath KnitClothOrder/KCCObody/KCCOitem/endUseGroup/csRange/garmentVariant) 0-9 (N)</p> <p>- note: <i>used only if not already specified in the article code</i> (XPath KnitClothOrder/KCCObody/KCCOitem/apparelProd/csRange/garmentVariant) 0-9 (N)</p> <p>- note: <i>used only if not already specified in the article code</i> (XPath KnitClothOrder/KCCObody/KCCOitem/garTecSheet/garmentCode/garmentCodeB/garmentVariant) 0-9 (N) (XPath KnitClothOrder/KCCObody/KCCOitem/apparelProd/garmentCode/garmentCodeB/garmentVariant) 0-9 (N)</p>
<b>garPack</b>	<p>the packaging mode of the item or a part of it. (XPath KnitClothOrder/garComInfo/garPack) 0-1 (N) (XPath KnitClothOrder/KCCObody/KCCOitem/garComInfo/garPack) 0-1 (N) (XPath KnitClothOrder/KCCObody/KCCOitem/packages/handlingChar/garPack) 0-1 (N) (XPath KnitClothOrder/KCCObody/KCCOitem/phase/packages/handlingChar/garPack) 0-1 (N)</p>
<b>garSizeSet</b>	<p>size table for a garment (XPath KnitClothOrder/KCCObody/KCCOitem/garTecSheet/garSizeSet) 0-1 (A)</p>
<b>garSizeTier</b>	<p>definition of the range of sizes associated with a given code (XPath KnitClothOrder/KCCObody/KCCOitem/garTecSheet/garSizeSet/garSizeTier) 1-9</p>
<b>garTecSheet</b>	<p>garment technical sheet (XPath KnitClothOrder/KCCObody/KCCOitem/garTecSheet) 0-1</p>
<b>handlingChar</b>	<p>features of an item (item or package) useful for its transport and warehouse management. (XPath KnitClothOrder/KCCObody/KCCOitem/packages/handlingChar) 0-1 (N) - note: <i>in this case the characteristics are related to the package.</i> (XPath KnitClothOrder/KCCObody/KCCOitem/phase/packages/handlingChar) 0-1 (N) - note: <i>in this case the characteristics are related to the package.</i></p>
<b>insPayment</b>	<p>payment details for payment by installments (XPath KnitClothOrder/terms/insPayment) 0-5 - note: <i>excluded the case of offers, this set of data is alternative to payment set and must be iterated for each payment installment</i></p>
<b>itemIdentification</b>	<p>serial identification of a product unit (XPath KnitClothOrder/KCCObody/KCCOitem/endUseGroup/csRange/sizeMatrix/sizeRow/itemsList/itemIdentification) 1-unbounded (N) - note: <i>identification of the single product unit contained in the list</i> (XPath KnitClothOrder/KCCObody/KCCOitem/phase/lotDetails/csRange/sizeMatrix/sizeRow/itemsList/itemIdentification) 1-unbounded (N) - note: <i>identification of the single product unit contained in the list</i> (XPath KnitClothOrder/KCCObody/KCCOitem/apparelComponent/fabricComponent/itemsList/itemIdentification) 1-unbounded (N) - note: <i>identification of the single product unit contained in the list</i> (XPath KnitClothOrder/KCCObody/KCCOitem/apparelProd/csRange/sizeMatrix/sizeRow/itemsList/itemIdentification) 1-unbounded (N) - note: <i>identification of the single product unit contained in the list</i> (XPath KnitClothOrder/KCCObody/KCCOitem/progress/itemsList/itemIdentification) 1-unbounded (N) - note: <i>identification of the single product unit contained in the list</i></p>
<b>itemsList</b>	<p>list of the single product units</p>

	<p>(XPath KnitClothOrder/KCCObody/KCCOitem/endUseGroup/csRange/sizeMatrix/sizeRow/itemsList) 0-1 (N)</p> <p>- note: <i>the usage in this position is alternative to its usage within the document line element</i></p> <p>(XPath KnitClothOrder/KCCObody/KCCOitem/apparelComponent/fabricComponent/itemsList) 0-unbounded (N)</p> <p>- note: <i>it may be used to identify the pieces/chains that the Subcontractor must use for the commissioned work with multiple serial Ids for each one</i></p> <p>(XPath KnitClothOrder/KCCObody/KCCOitem/phase/lotDetails/csRange/sizeMatrix/sizeRow/itemsList) 0-1 (N)</p> <p>- note: <i>the usage in this position is alternative to its usage within the document line element</i></p> <p>(XPath KnitClothOrder/KCCObody/KCCOitem/apparelProd/csRange/sizeMatrix/sizeRow/itemsList) 0-1 (N)</p> <p>- note: <i>the usage in this position is alternative to its usage within the document line element</i></p> <p>(XPath KnitClothOrder/KCCObody/KCCOitem/progress/itemsList) 0-1 (N)</p>
<b>KCCObody</b>	<p>body of the document FASHION COMMISSION ORDER (ex GARMENT COMMISSION ORDER)</p> <p>(XPath KnitClothOrder/KCCObody) 1-1</p>
<b>KCCOheader</b>	<p>header of the document FASHION COMMISSION ORDER</p> <p>(XPath KnitClothOrder/KCCOheader) 1-1 (P)</p>
<b>KCCOitem</b>	<p>line of the document GARMENT COMMISSION ORDER</p> <p>(XPath KnitClothOrder/KCCObody/KCCOitem) 1-unbounded (P)</p>
<b>lotDetails</b>	<p>details about the lot to be assigned to a group of items.</p> <p>(XPath KnitClothOrder/KCCObody/KCCOitem/phase/lotDetails) 0-99 (N)</p>
<b>packageDim</b>	<p>dimensions of a transport package</p> <p>(XPath KnitClothOrder/KCCObody/KCCOitem/phase/packages/packageDim) 0-1</p> <p>(XPath KnitClothOrder/KCCObody/KCCOitem/packages/packageDim) 0-1</p>
<b>packages</b>	<p>describes the composition of the transport packaging. Each element corresponds to a type of package: type, quantity, hierarchic level, list of identifiers of the single packages</p> <p>(XPath KnitClothOrder/KCCObody/KCCOitem/phase/packages) 0-99 (P)</p> <p>(XPath KnitClothOrder/KCCObody/KCCOitem/packages) 0-99 (Pp)</p>
<b>payment</b>	<p>payment details for payment all in one</p> <p>(XPath KnitClothOrder/terms/payment) 0-5</p> <p>- note: <i>excluded the case of offers, this set of data is alternative to insPayment, it can be iterated to specify alternative terms of payment (e.g.: 60 days or 30 days with 3% discount)</i></p>
<b>phase</b>	<p>a production phase of a fashion product.</p> <p>(XPath KnitClothOrder/KCCObody/KCCOitem/phase) 0-99 (N)</p>
<b>piecePack</b>	<p>type of wrapping or packing of the fabric pieces</p> <p>(XPath KnitClothOrder/garComInfo/piecePack) 0-1 (p)</p> <p>(XPath KnitClothOrder/KCCObody/KCCOitem/garComInfo/piecePack) 0-1 (p)</p> <p>(XPath KnitClothOrder/KCCObody/KCCOitem/phase/packages/handlingChar/piecePack) 0-1</p> <p>(XPath KnitClothOrder/KCCObody/KCCOitem/packages/handlingChar/piecePack) 0-1</p>
<b>progress</b>	<p>description of the progress of a production lot in a manufacturing process</p> <p>(XPath KnitClothOrder/KCCObody/KCCOitem/progress) 0-9 (P)</p> <p>- note: <i>In this case the progress element states an expected date for the production steps.</i></p>
<b>refDoc</b>	<p>identification of a document and of an item thereof, to which the message makes reference</p> <p>(XPath KnitClothOrder/KCCObody/KCCOitem/appMnfrOperation/refDoc) 0-9 (P)</p>



	<p>(XPath KnitClothOrder/KCCObody/KCCOitem/apparelComponent/garmentPartComponent/refDoc) 0-9 (P)</p> <p>(XPath KnitClothOrder/KCCObody/KCCOitem/phase/refDoc) 0-99 (P)</p> <p>(XPath KnitClothOrder/KCCObody/KCCOitem/apparelComponent/yarnComponent/refDoc) 0-9 (P)</p> <p>- note: <i>here the delivery document can be specified</i></p> <p>(XPath KnitClothOrder/KCCObody/KCCOitem/apparelComponent/acsComponent/refDoc) 0-9 (P)</p> <p>(XPath KnitClothOrder/KCCObody/KCCOitem/apparelComponent/fabricComponent/refDoc) 0-9 (P)</p> <p>- note: <i>here the delivery documents can be specified</i></p> <p>(XPath KnitClothOrder/KCCOheader/refDoc) 0-9 (P)</p> <p>(XPath KnitClothOrder/KCCObody/KCCOitem/garTecSheet/refDoc) 0-9 (P)</p>
<b>sizeMatrix</b>	<p>size matrix of an apparel product</p> <p>(XPath KnitClothOrder/KCCObody/KCCOitem/endUseGroup/csRange/sizeMatrix) 1-1</p> <p>(XPath KnitClothOrder/KCCObody/KCCOitem/phase/lotDetails/csRange/sizeMatrix) 1-1</p> <p>(XPath KnitClothOrder/KCCObody/KCCOitem/apparelProd/csRange/sizeMatrix) 1-1</p>
<b>sizeRow</b>	<p>size matrix row of an apparel product</p> <p>(XPath KnitClothOrder/KCCObody/KCCOitem/apparelProd/csRange/sizeMatrix/sizeRow) 1-99 (P)</p> <p>(XPath KnitClothOrder/KCCObody/KCCOitem/phase/lotDetails/csRange/sizeMatrix/sizeRow) 1-99 (P)</p> <p>(XPath KnitClothOrder/KCCObody/KCCOitem/endUseGroup/csRange/sizeMatrix/sizeRow) 1-99 (P)</p>
<b>subContractor</b>	<p>details of the Sub-contractor</p> <p>- base type: Nad,</p> <p>(XPath KnitClothOrder/KCCOheader/subContractor) 1-1 (AP)</p>
<b>terms</b>	<p>details of the commercial obligations for payment and delivery</p> <p>(XPath KnitClothOrder/terms) 0-1 (P)</p>
<b>texCode</b>	<p>full codification of the textile product</p> <p>(XPath KnitClothOrder/KCCObody/KCCOitem/phase/garConsumptionSet/texCode) 1-1 (P)</p> <p>(XPath KnitClothOrder/KCCObody/KCCOitem/garTecSheet/garConsumptionSet/texCode) 1-1 (P)</p> <p>(XPath KnitClothOrder/KCCObody/KCCOitem/apparelComponent/fabricComponent/texCode) 1-1 (P)</p>
<b>thirdParty</b>	<p>details of the Third Party, different from Sender and Receiver of the document</p> <p>- base type: Nad,</p> <p>(XPath KnitClothOrder/KCCObody/KCCOitem/phase/thirdParty) 0-9 (AP)</p> <p>(XPath KnitClothOrder/KCCObody/KCCOitem/thirdParty) 0-5 (AP)</p> <p>(XPath KnitClothOrder/KCCOheader/thirdParty) 0-5 (AP)</p> <p>- note: <i>here the Party to whom the Subcontractor must send the semi-finished products for subsequent operations can be specified</i></p>
<b>trade</b>	<p>general terms of trade for the specified supply</p> <p>(XPath KnitClothOrder/terms/trade) 0-1</p>
<b>transInfo</b>	<p>details of transport: mode, carrier and delivery place</p> <p>(XPath KnitClothOrder/terms/transInfo) 0-5 (pAP)</p>
<b>yarnCode</b>	<p>full codification of a yarn product</p> <p>(XPath KnitClothOrder/KCCObody/KCCOitem/apparelComponent/yarnComponent/yarnCode) 1-1 (P)</p> <p>- note: <i>here is the code of the component used in the yarn manufacturing operation</i></p>

	(XPath KnitClothOrder/KCCObody/KCCOitem/phase/garConsumptionSet/yarnCode) 1-1 (P) (XPath KnitClothOrder/KCCObody/KCCOitem/garTecSheet/garConsumptionSet/yarnCode) 1-1 (P)
<b>yarnComponent</b>	identification details of a yarn used in a sub-contracted manufacturing operation (XPath KnitClothOrder/KCCObody/KCCOitem/apparelComponent/yarnComponent) 0-9 (P)
<b>yarnInWrap</b>	details specifying the inner wrapping of a yarn product (XPath KnitClothOrder/garComInfo/yarnPack/yarnInWrap) 0-1 (XPath KnitClothOrder/KCCObody/KCCOitem/phase/packages/handlingChar/yarnPack/yarnInWrap) 0-1 (XPath KnitClothOrder/KCCObody/KCCOitem/packages/handlingChar/yarnPack/yarnInWrap) 0-1 (XPath KnitClothOrder/KCCObody/KCCOitem/garComInfo/yarnPack/yarnInWrap) 0-1
<b>yarnPack</b>	details of type of presentation used for the yarn (XPath KnitClothOrder/KCCObody/KCCOitem/garComInfo/yarnPack) 0-1 (p) (XPath KnitClothOrder/KCCObody/KCCOitem/phase/packages/handlingChar/yarnPack) 0-1 (XPath KnitClothOrder/garComInfo/yarnPack) 0-1 (p) (XPath KnitClothOrder/KCCObody/KCCOitem/packages/handlingChar/yarnPack) 0-1
<b>yarnReel</b>	details of the packaging of a yarn product (bobbin and reel,...) (XPath KnitClothOrder/KCCObody/KCCOitem/phase/packages/handlingChar/yarnPack/yarnReel) 1-1 (XPath KnitClothOrder/KCCObody/KCCOitem/garComInfo/yarnPack/yarnReel) 1-1 (XPath KnitClothOrder/garComInfo/yarnPack/yarnReel) 1-1 (XPath KnitClothOrder/KCCObody/KCCOitem/packages/handlingChar/yarnPack/yarnReel) 1-1

## 2.2.2 Simple elements (Basic Business Information Entities)

Simple elements are those elements whose content is characterized by a data type plus a domain of possible values. Simple elements are alphabetically ordered.

AC_amount	amount of an Allowance or Charge - base type: decimal, fraction digits: 2, (XPath KnitClothOrder/terms/allowanceCharge/AC_amount) 1-1 (A)
AC_category	coded specification of an Allowance or Charge - base type: string, cod. table: T41 <a href="http://www.ebiz.enea.it/moda-ml/repository/codelist/v2018-1/gc_T41.xml">http://www.ebiz.enea.it/moda-ml/repository/codelist/v2018-1/gc_T41.xml</a> (XPath KnitClothOrder/terms/allowanceCharge/AC_category) 1-1
AC_categoryText	free text description of an Allowance or Charge - base type: string, max length: 250, (XPath KnitClothOrder/terms/allowanceCharge/AC_categoryText) 1-1 (U)
AC_percent	amount of an Allowance or Charge as a percentage (always non negative value) - base type: decimal, max inclusive: 100, fraction digits: 2, (XPath KnitClothOrder/terms/allowanceCharge/AC_percent) 1-1
acsPackCode	code specifying the type of wrapping or packing used for the accessory - base type: string, (XPath KnitClothOrder/KCCObody/KCCOitem/packages/handlingChar/acsPack/acsPackCode) 1-1 (AU)



	<p>(XPath KnitClothOrder/KCCObody/KCCOitem/garComInfo/acsPack/acsPackCode) 1-1 (AU)</p> <p>(XPath KnitClothOrder/garComInfo/acsPack/acsPackCode) 1-1 (AU)</p> <p>(XPath KnitClothOrder/KCCObody/KCCOitem/phase/packages/handlingChar/acsPack/acsPackCode) 1-1 (AU)</p>
acsPackText	<p>free text specifying the type of wrapping or packing used for the accessory</p> <p>- base type: string, max length: 250,</p> <p>(XPath KnitClothOrder/KCCObody/KCCOitem/garComInfo/acsPack/acsPackText) 1-1 (U)</p> <p>(XPath KnitClothOrder/garComInfo/acsPack/acsPackText) 1-1 (U)</p> <p>(XPath KnitClothOrder/KCCObody/KCCOitem/phase/packages/handlingChar/acsPack/acsPackText) 1-1 (U)</p> <p>(XPath KnitClothOrder/KCCObody/KCCOitem/packages/handlingChar/acsPack/acsPackText) 1-1 (U)</p>
added	<p>additional code of the product (complementing the formers)</p> <p>- base type: string, max length: 80,</p> <p>(XPath KnitClothOrder/KCCObody/KCCOitem/apparelComponent/fabricComponent/texCode/added) 0-9</p> <p>- note: <i>here an additional codification (see table T44) can be specified</i></p> <p>(XPath KnitClothOrder/KCCObody/KCCOitem/garTecSheet/garConsumptionSet/acsCode/added) 0-9</p> <p>- note: <i>here an additional codification (see table T44) can be specified</i></p> <p>(XPath KnitClothOrder/KCCObody/KCCOitem/phase/garConsumptionSet/garmentPartCode/added) 0-19</p> <p>(XPath KnitClothOrder/KCCObody/KCCOitem/phase/garConsumptionSet/yarnCode/added) 0-9</p> <p>- note: <i>here an additional codification (see table T44) can be specified</i></p> <p>(XPath KnitClothOrder/KCCObody/KCCOitem/phase/garConsumptionSet/garmentCode/garmentCodeB/added) 0-9</p> <p>(XPath KnitClothOrder/KCCObody/KCCOitem/apparelComponent/acsCode/added) 0-9</p> <p>- note: <i>here an additional codification (see table T44) can be specified</i></p> <p>(XPath KnitClothOrder/KCCObody/KCCOitem/apparelProd/garmentPartCode/added) 0-19</p> <p>(XPath KnitClothOrder/KCCObody/KCCOitem/garTecSheet/garConsumptionSet/yarnCode/added) 0-9</p> <p>- note: <i>here an additional codification (see table T44) can be specified</i></p> <p>(XPath KnitClothOrder/KCCObody/KCCOitem/garTecSheet/garConsumptionSet/garmentPartCode/added) 0-19</p> <p>(XPath KnitClothOrder/KCCObody/KCCOitem/apparelComponent/garmentPartComponent/garmentPartCode/added) 0-19</p> <p>(XPath KnitClothOrder/KCCObody/KCCOitem/apparelComponent/yarnComponent/yarnCode/added) 0-9</p> <p>- note: <i>here an additional codification (see table T44) can be specified</i></p> <p>(XPath KnitClothOrder/KCCObody/KCCOitem/apparelProd/garmentCode/garmentCodeB/added) 0-9</p> <p>(XPath KnitClothOrder/KCCObody/KCCOitem/phase/garConsumptionSet/acsCode/added) 0-9</p> <p>- note: <i>here an additional codification (see table T44) can be specified</i></p> <p>(XPath KnitClothOrder/KCCObody/KCCOitem/phase/garConsumptionSet/texCode/added) 0-9</p> <p>- note: <i>here an additional codification (see table T44) can be specified</i></p> <p>(XPath KnitClothOrder/KCCObody/KCCOitem/garTecSheet/garConsumptionSet/texCode/added) 0-9</p> <p>- note: <i>here an additional codification (see table T44) can be specified</i></p> <p>(XPath KnitClothOrder/KCCObody/KCCOitem/garTecSheet/garConsumptionSet/garmentCode/garmentCodeB/added) 0-9</p> <p>(XPath KnitClothOrder/KCCObody/KCCOitem/garTecSheet/garmentCode/garmentCodeB/added) 0-9</p>

additionalComponentCode	<p>an additional code to identify a fashion product or a part of it (it is a way to codify the item, but it is not one of the codes to identify it). It is not a serial identifier.</p> <p>- base type: string,  (XPath KnitClothOrder/KCCObody/KCCOitem/endUseGroup/csRange/sizeMatrix/sizeRow/additionalComponentCode) 0-9 (N)  (XPath KnitClothOrder/KCCObody/KCCOitem/phase/lotDetails/csRange/sizeMatrix/sizeRow/additionalComponentCode) 0-9 (N)  (XPath KnitClothOrder/KCCObody/KCCOitem/apparelProd/csRange/sizeMatrix/sizeRow/additionalComponentCode) 0-9 (N)</p>
additionalIdentifier	<p>additional identification code of a Party, for example customs registries or others</p> <p>- base type: string, max length: 15,  (XPath KnitClothOrder/KCCOheader/buyer/additionalIdentifier) 0-9 (N)  - note: <i>identifiers for example for exports, such as MID (Manufacturer Identification Code), EORI (E.O.R.I. - Economic Operator Registration and Identification)</i></p>
@addType	<p>qualifier of the additional coding of a product</p> <p>- base type: string, cod. table: T44  <a href="http://www.ebiz.enea.it/moda-ml/repository/codelist/v2018-1/gc_T44.xml">http://www.ebiz.enea.it/moda-ml/repository/codelist/v2018-1/gc_T44.xml</a>  (XPath KnitClothOrder/KCCObody/KCCOitem/apparelComponent/fabricComponent/texCode/added/@addType) [Optional]  - nota: <i>addType allows the clarification of the meaning of the added element content; it is strongly suggested to use it always.</i>  (XPath KnitClothOrder/KCCObody/KCCOitem/apparelProd/garmentCode/garmentCodeB/added/@addType) [Optional]  - nota: <i>addType allows the clarification of the meaning of the added element content; it is strongly suggested to use it always.</i>  (XPath KnitClothOrder/KCCObody/KCCOitem/phase/garConsumptionSet/yarnCode/added/@addType) [Optional]  - nota: <i>addType allows the clarification of the meaning of the added element content; it is strongly suggested to use it always.</i>  (XPath KnitClothOrder/KCCObody/KCCOitem/phase/garConsumptionSet/garmentPartCode/added/@addType) [Optional]  - nota: <i>addType allows the clarification of the meaning of the added element content; it is strongly suggested to use it always.</i>  (XPath KnitClothOrder/KCCObody/KCCOitem/apparelProd/garmentPartCode/added/@addType) [Optional]  - nota: <i>addType allows the clarification of the meaning of the added element content; it is strongly suggested to use it always.</i>  (XPath KnitClothOrder/KCCObody/KCCOitem/garTecSheet/garmentCode/garmentCodeB/added/@addType) [Optional]  - nota: <i>addType allows the clarification of the meaning of the added element content; it is strongly suggested to use it always.</i>  (XPath KnitClothOrder/KCCObody/KCCOitem/apparelComponent/garmentPartComponent/garmentPartCode/added/@addType) [Optional]  - nota: <i>addType allows the clarification of the meaning of the added element content; it is strongly suggested to use it always.</i>  (XPath KnitClothOrder/KCCObody/KCCOitem/garTecSheet/garConsumptionSet/garmentCode/garmentCodeB/added/@addType) [Optional]  - nota: <i>addType allows the clarification of the meaning of the added element content; it is strongly suggested to use it always.</i>  (XPath KnitClothOrder/KCCObody/KCCOitem/phase/garConsumptionSet/garmentCode/garmentCodeB/added/@addType) [Optional]  - nota: <i>addType allows the clarification of the meaning of the added element content; it is strongly suggested to use it always.</i>  (XPath KnitClothOrder/KCCObody/KCCOitem/garTecSheet/garConsumptionSet/texCode/added/@addType) [Optional]</p>

	<p>- nota: <i>addType</i> allows the clarification of the meaning of the added element content; it is strongly suggested to use it always. (XPath KnitClothOrder/KCCObody/KCCOitem/apparelComponent/acsComponent/acsCode/added/@addType) [Optional]</p> <p>- nota: <i>addType</i> allows the clarification of the meaning of the added element content; it is strongly suggested to use it always. (XPath KnitClothOrder/KCCObody/KCCOitem/phase/garConsumptionSet/texCode/added/@addType) [Optional]</p> <p>- nota: <i>addType</i> allows the clarification of the meaning of the added element content; it is strongly suggested to use it always. (XPath KnitClothOrder/KCCObody/KCCOitem/garTecSheet/garConsumptionSet/acsCode/added/@addType) [Optional]</p> <p>- nota: <i>addType</i> allows the clarification of the meaning of the added element content; it is strongly suggested to use it always. (XPath KnitClothOrder/KCCObody/KCCOitem/apparelComponent/yarnComponent/yarnCode/added/@addType) [Optional]</p> <p>- nota: <i>addType</i> allows the clarification of the meaning of the added element content; it is strongly suggested to use it always. (XPath KnitClothOrder/KCCObody/KCCOitem/phase/garConsumptionSet/acsCode/added/@addType) [Optional]</p> <p>- nota: <i>addType</i> allows the clarification of the meaning of the added element content; it is strongly suggested to use it always. (XPath KnitClothOrder/KCCObody/KCCOitem/garTecSheet/garConsumptionSet/yarnCode/added/@addType) [Optional]</p> <p>- nota: <i>addType</i> allows the clarification of the meaning of the added element content; it is strongly suggested to use it always. (XPath KnitClothOrder/KCCObody/KCCOitem/garTecSheet/garConsumptionSet/garmentPartCode/added/@addType) [Optional]</p> <p>- nota: <i>addType</i> allows the clarification of the meaning of the added element content; it is strongly suggested to use it always.</p>
appJob	<p>operation of a work cycle for garment manufacturing</p> <p>- base type: string, cod. table: T205 <a href="http://www.ebiz.enea.it/moda-ml/repository/codelist/v2018-1/gc_T205.xml">http://www.ebiz.enea.it/moda-ml/repository/codelist/v2018-1/gc_T205.xml</a> (XPath KnitClothOrder/KCCObody/KCCOitem/appMnfrOperation/appJob) 1-1</p>
appJobTech	<p>operation technology for garment production</p> <p>- base type: string, cod. table: T265 <a href="http://www.ebiz.enea.it/moda-ml/repository/codelist/v2018-1/gc_T265.xml">http://www.ebiz.enea.it/moda-ml/repository/codelist/v2018-1/gc_T265.xml</a> (XPath KnitClothOrder/KCCObody/KCCOitem/appMnfrOperation/appJobTech) 0-1</p>
@application	<p>force or similar condition (e.g. no. of revolutions) applied in a test as specified within the standard</p> <p>- base type: string, max length: 15, (XPath KnitClothOrder/KCCObody/KCCOitem/garTecSheet/garMeaSet/garMea/specValue/@application) [Optional]</p>
appMachine	<p>machine used in an operation of a work cycle for garment production</p> <p>- base type: string, cod. table: T275 <a href="http://www.ebiz.enea.it/moda-ml/repository/codelist/v2018-1/gc_T275.xml">http://www.ebiz.enea.it/moda-ml/repository/codelist/v2018-1/gc_T275.xml</a> (XPath KnitClothOrder/KCCObody/KCCOitem/appMnfrOperation/appMachine) 0-1</p>
art	<p>article number of the product</p> <p>- base type: string, max length: 80, (XPath KnitClothOrder/KCCObody/KCCOitem/phase/garConsumptionSet/yarnCode/art) 1-1 (U) (XPath KnitClothOrder/KCCObody/KCCOitem/apparelProd/garmentCode/garmentCodeA/art) 1-1 (U) (XPath KnitClothOrder/KCCObody/KCCOitem/garTecSheet/garConsumptionSet/texCode/art) 1-1 (U)</p> <p>- note: can be used either for the base-article (excluding pattern/colour) or for the SKU</p>

	<p>(XPath KnitClothOrder/KCCObody/KCCOitem/phase/garConsumptionSet/acsCode/art) 1-1 (U)</p> <p>(XPath KnitClothOrder/KCCObody/KCCOitem/garTecSheet/garConsumptionSet/garmentCode/garmentCodeA/art) 1-1 (U)</p> <p>(XPath KnitClothOrder/KCCObody/KCCOitem/garTecSheet/garConsumptionSet/yarnCode/art) 1-1 (U)</p> <p>(XPath KnitClothOrder/KCCObody/KCCOitem/garTecSheet/garmentCode/garmentCodeA/art) 1-1 (U)</p> <p>(XPath KnitClothOrder/KCCObody/KCCOitem/phase/garConsumptionSet/texCode/art) 1-1 (U)</p> <p>- note: can be used either for the base-article (excluding pattern/colour) or for the SKU</p> <p>(XPath KnitClothOrder/KCCObody/KCCOitem/phase/garConsumptionSet/garmentCode/garmentCodeA/art) 1-1 (U)</p> <p>(XPath KnitClothOrder/KCCObody/KCCOitem/apparelComponent/yarnComponent/yarnCode/art) 1-1 (U)</p> <p>(XPath KnitClothOrder/KCCObody/KCCOitem/apparelComponent/acsComponent/acsCode/art) 1-1 (U)</p> <p>(XPath KnitClothOrder/KCCObody/KCCOitem/apparelComponent/fabricComponent/texCode/art) 1-1 (U)</p> <p>- note: can be used either for the base-article (excluding pattern/colour) or for the SKU</p> <p>(XPath KnitClothOrder/KCCObody/KCCOitem/garTecSheet/garConsumptionSet/acsCode/art) 1-1 (U)</p>
artGroup	<p>code identifying a class of products</p> <p>- base type: string, max length: 40,</p> <p>(XPath KnitClothOrder/KCCObody/KCCOitem/phase/garConsumptionSet/garmentCode/garmentCodeB/artGroup) 0-1</p> <p>(XPath KnitClothOrder/KCCObody/KCCOitem/garTecSheet/garmentCode/garmentCodeB/artGroup) 0-1</p> <p>(XPath KnitClothOrder/KCCObody/KCCOitem/apparelProd/garmentCode/garmentCodeB/artGroup) 0-1</p> <p>(XPath KnitClothOrder/KCCObody/KCCOitem/garTecSheet/garConsumptionSet/garmentCode/garmentCodeB/artGroup) 0-1</p>
binaryObject	<p>a binary large object containing an attached document, Coding 'base64Binary' is recommended.</p> <p>- base type: base64Binary,</p> <p>(XPath KnitClothOrder/KCCObody/KCCOitem/phase/refDoc/attachment/binaryObject) 0-1 (N)</p> <p>(XPath KnitClothOrder/KCCObody/KCCOitem/apparelComponent/acsComponent/refDoc/attachment/binaryObject) 0-1 (N)</p> <p>(XPath KnitClothOrder/KCCObody/KCCOitem/appMnfrOperation/refDoc/attachment/binaryObject) 0-1 (N)</p> <p>(XPath KnitClothOrder/KCCObody/KCCOitem/apparelComponent/yarnComponent/refDoc/attachment/binaryObject) 0-1 (N)</p> <p>(XPath KnitClothOrder/KCCObody/KCCOitem/garTecSheet/refDoc/attachment/binaryObject) 0-1 (N)</p> <p>(XPath KnitClothOrder/KCCObody/KCCOitem/apparelComponent/fabricComponent/refDoc/attachment/binaryObject) 0-1 (N)</p> <p>(XPath KnitClothOrder/KCCOheader/refDoc/attachment/binaryObject) 0-1 (N)</p> <p>(XPath KnitClothOrder/KCCObody/KCCOitem/apparelComponent/garmentPartComponent/refDoc/attachment/binaryObject) 0-1 (N)</p>
brand	<p>A brand name.</p> <p>- base type: string,</p> <p>(XPath KnitClothOrder/garComInfo/brand) 0-1 (N)</p> <p>(XPath KnitClothOrder/KCCObody/KCCOitem/garComInfo/brand) 0-1 (N)</p>
carrier	<p>identification of the transport carrier</p> <p>- base type: string, max length: 40,</p> <p>(XPath KnitClothOrder/terms/transInfo/carrier) 0-1</p>

<p>@characterSet</p>	<p>the character set of the binary object (examples UTF-8, UTF-16, Windows-1252, ISO-8859-7,..)</p> <p>- base type: normalizedString,</p> <p>(XPath KnitClothOrder/KCCObody/KCCOitem/phase/refDoc/attachment/binaryObject/@characterSet) [Optional] (Na)</p> <p>(XPath KnitClothOrder/KCCObody/KCCOitem/apparelComponent/garmentPartComponent/refDoc/attachment/binaryObject/@characterSet) [Optional] (Na)</p> <p>(XPath KnitClothOrder/KCCOheader/refDoc/attachment/binaryObject/@characterSet) [Optional] (N)</p> <p>(XPath KnitClothOrder/KCCObody/KCCOitem/apparelComponent/fabricComponent/refDoc/attachment/binaryObject/@characterSet) [Optional] (Na)</p> <p>(XPath KnitClothOrder/KCCObody/KCCOitem/apparelComponent/acsComponent/refDoc/attachment/binaryObject/@characterSet) [Optional] (Na)</p> <p>(XPath KnitClothOrder/KCCObody/KCCOitem/appMnfrOperation/refDoc/attachment/binaryObject/@characterSet) [Optional] (Na)</p> <p>(XPath KnitClothOrder/KCCObody/KCCOitem/garTecSheet/refDoc/attachment/binaryObject/@characterSet) [Optional] (Na)</p> <p>(XPath KnitClothOrder/KCCObody/KCCOitem/apparelComponent/yarnComponent/refDoc/attachment/binaryObject/@characterSet) [Optional] (Na)</p>
<p>characterSetCode</p>	<p>the character set of an external document (examples UTF-8, UTF-16, Windows-1252, ISO-8859-7,..)</p> <p>- base type: normalizedString,</p> <p>(XPath KnitClothOrder/KCCObody/KCCOitem/garTecSheet/refDoc/attachment/externalReference/characterSetCode) 0-1 (N)</p> <p>(XPath KnitClothOrder/KCCObody/KCCOitem/apparelComponent/acsComponent/refDoc/attachment/externalReference/characterSetCode) 0-1 (N)</p> <p>(XPath KnitClothOrder/KCCObody/KCCOitem/appMnfrOperation/refDoc/attachment/externalReference/characterSetCode) 0-1 (N)</p> <p>(XPath KnitClothOrder/KCCObody/KCCOitem/phase/refDoc/attachment/externalReference/characterSetCode) 0-1 (N)</p> <p>(XPath KnitClothOrder/KCCObody/KCCOitem/apparelComponent/garmentPartComponent/refDoc/attachment/externalReference/characterSetCode) 0-1 (N)</p> <p>(XPath KnitClothOrder/KCCObody/KCCOitem/apparelComponent/yarnComponent/refDoc/attachment/externalReference/characterSetCode) 0-1 (N)</p> <p>(XPath KnitClothOrder/KCCObody/KCCOitem/apparelComponent/fabricComponent/refDoc/attachment/externalReference/characterSetCode) 0-1 (N)</p> <p>(XPath KnitClothOrder/KCCOheader/refDoc/attachment/externalReference/characterSetCode) 0-1 (N)</p>
<p>city</p>	<p>name of the city (town, village)</p> <p>- base type: string, max length: 40,</p> <p>(XPath KnitClothOrder/KCCOheader/buyer/city) 0-1</p> <p>(XPath KnitClothOrder/KCCOheader/thirdParty/city) 0-1</p> <p>(XPath KnitClothOrder/KCCObody/KCCOitem/thirdParty/city) 0-1</p> <p>(XPath KnitClothOrder/KCCOheader/subContractor/city) 0-1</p> <p>(XPath KnitClothOrder/KCCObody/KCCOitem/phase/thirdParty/city) 0-1</p>
<p>@codeList</p>	<p>it specifies the URL where the list of codes used to make an instance of the element can be found</p> <p>- base type: string, max length: 255,</p> <p>(XPath KnitClothOrder/KCCObody/KCCOitem/garTecSheet/garConsumptionSet/garmentPartCode/fabric/@codeList) [Optional]</p> <p>- nota: <i>at least one out of this attribute and "numberingOrg" should be set</i></p> <p>(XPath KnitClothOrder/KCCObody/KCCOitem/phase/lotDetails/csRange/sizeMatrix/sizeRow/itemsList/qualityLevel/@codeList) [Optional] (a)</p> <p>- nota: <i>at least one out of this attribute and "numberingOrg" should be set</i></p>

(XPath  
 KnitClothOrder/KCCObody/KCCOitem/phase/garConsumptionSet/garmentCode/garmentCodeB/artGroup/@codeList) [Optional]  
 - nota: *at least one out of this attribute and "numberingOrg" should be set*  
 (XPath KnitClothOrder/KCCObody/KCCOitem/appMnfrOperation/note/@codeList) [Optional]  
 - nota: *must be used to provide (URL) the list of codes used in "noteLabel"*  
 (XPath KnitClothOrder/KCCObody/KCCOitem/garTecSheet/garConsumptionSet/garmentPartCode/color/@codeList) [Optional]  
 - nota: *this attribute should be used either single or coupled with "listName" and "listVersion"*  
 (XPath  
 KnitClothOrder/KCCObody/KCCOitem/phase/garConsumptionSet/garmentCode/garmentCodeA/art/@codeList) [Optional]  
 - nota: *at least one out of this attribute and "numberingOrg" should be set*  
 (XPath  
 KnitClothOrder/KCCObody/KCCOitem/phase/garConsumptionSet/garmentCode/garmentCodeB/size/@codeList) [Optional]  
 (XPath KnitClothOrder/KCCObody/KCCOitem/apparelProd/note/@codeList) [Optional]  
 - nota: *must be used to provide (URL) the list of codes used in "noteLabel"*  
 (XPath KnitClothOrder/KCCObody/KCCOitem/phase/phaseCode/@codeList) [Optional] (a)  
 - nota: *at least one out of this attribute and "numberingOrg" should be set*  
 (XPath  
 KnitClothOrder/KCCObody/KCCOitem/phase/garConsumptionSet/texCode/art/@codeList) [Optional]  
 - nota: *at least one out of this attribute and "numberingOrg" should be set*  
 (XPath KnitClothOrder/KCCObody/KCCOitem/apparelProd/csRange/garmentVariant/variantCode/@codeList) [Optional] (a)  
 - nota: *at least one out of this attribute and "numberingOrg" should be set*  
 (XPath KnitClothOrder/KCCObody/KCCOitem/garTecSheet/garConsumptionSet/garmentCode/garmentCodeB/color/@codeList) [Optional]  
 - nota: *this attribute should be used either single or coupled with "listName" and "listVersion"*  
 (XPath KnitClothOrder/KCCObody/KCCOitem/apparelComponent/garmentPartComponent/garmentPartCode/fabric/@codeList) [Optional]  
 - nota: *at least one out of this attribute and "numberingOrg" should be set*  
 (XPath  
 KnitClothOrder/KCCObody/KCCOitem/phase/garConsumptionSet/acsCode/color/@codeList) [Optional]  
 - nota: *this attribute should be used either single or coupled with "listName" and "listVersion"*  
 (XPath KnitClothOrder/KCCObody/KCCOitem/apparelProd/csRange/drop/@codeList) [Optional]  
 (XPath KnitClothOrder/KCCObody/KCCOitem/apparelComponent/garmentPartComponent/garmentPartCode/mod/@codeList) [Optional]  
 - nota: *at least one out of this attribute and "numberingOrg" should be set*  
 (XPath KnitClothOrder/KCCObody/KCCOitem/apparelProd/csRange/color/@codeList) [Optional]  
 - nota: *this attribute should be used either single or coupled with "listName" and "listVersion"*  
 (XPath KnitClothOrder/KCCObody/KCCOitem/apparelComponent/yarnComponent/yarnCode/art/@codeList) [Optional]  
 - nota: *at least one out of this attribute and "numberingOrg" should be set*  
 (XPath KnitClothOrder/KCCObody/KCCOitem/garTecSheet/garConsumptionSet/garmentCode/garmentCodeB/garmentVariant/variantType/@codeList) [Optional] (a)  
 - nota: *always at least one out of this attribute and "numberingOrg" should be set*  
 (XPath KnitClothOrder/KCCObody/KCCOitem/apparelProd/csRange/garmentVariant/variantType/@codeList) [Optional] (a)  
 - nota: *always at least one out of this attribute and "numberingOrg" should be set*



(XPath KnitClothOrder/KCCObody/KCCOitem/phase/refDoc/season/@codeList) [Optional]

- nota: *this attribute should be used either single or coupled with "listName" and "listVersion"*

(XPath KnitClothOrder/KCCObody/KCCOitem/progress/itemsList/qualityLevel/@codeList) [Optional] (a)

- nota: *at least one out of this attribute and "numberingOrg" should be set*

(XPath KnitClothOrder/KCCObody/KCCOitem/apparelProd/csRange/sizeMatrix/sizeRow/drop/@codeList) [Optional]

(XPath KnitClothOrder/KCCObody/KCCOitem/phase/garConsumptionSet/garConsumption/garSizeCode/@codeList) [Optional] (a)

- nota: *at least one out of this attribute and "numberingOrg" should be set*

(XPath KnitClothOrder/KCCObody/KCCOitem/packages/handlingChar/note/@codeList) [Optional]

- nota: *must be used to provide (URL) the list of codes used in "noteLabel"*

(XPath KnitClothOrder/KCCObody/KCCOitem/apparelProd/csRange/sizeMatrix/sizeRow/itemsList/qualityLevel/@codeList) [Optional] (a)

- nota: *at least one out of this attribute and "numberingOrg" should be set*

(XPath KnitClothOrder/KCCObody/KCCOitem/apparelComponent/fabricComponent/note/@codeList) [Optional]

- nota: *must be used to provide (URL) the list of codes used in "noteLabel"*

(XPath KnitClothOrder/KCCObody/KCCOitem/apparelProd/csRange/sizeMatrix/sizeRow/size/@codeList) [Optional]

(XPath KnitClothOrder/KCCObody/KCCOitem/phase/garConsumptionSet/acsCode/pattern/@codeList) [Optional]

- nota: *at least one out of this attribute and "numberingOrg" should be set*

(XPath KnitClothOrder/KCCObody/KCCOitem/garTecSheet/garConsumptionSet/garmentCode/garmentCodeB/fabric/@codeList) [Optional]

- nota: *at least one out of this attribute and "numberingOrg" should be set*

(XPath KnitClothOrder/KCCObody/KCCOitem/apparelComponent/yarnComponent/yarnCode/color/@codeList) [Optional]

- nota: *this attribute should be used either single or coupled with "listName" and "listVersion"*

(XPath KnitClothOrder/KCCObody/KCCOitem/apparelProd/csRange/sizeMatrix/sizeRow/additionalComponentCode/@codeList) [Optional] (a)

- nota: *at least one out of this attribute and "numberingOrg" should be set*

(XPath KnitClothOrder/KCCObody/KCCOitem/garTecSheet/garConsumptionSet/garmentPartCode/size/@codeList) [Optional]

(XPath KnitClothOrder/KCCObody/KCCOitem/garTecSheet/garConsumptionSet/garmentCode/garmentCodeB/mod/@codeList) [Optional]

- nota: *at least one out of this attribute and "numberingOrg" should be set*

(XPath KnitClothOrder/KCCObody/KCCOitem/garTecSheet/garConsumptionSet/garConsumption/garSizeCode/@codeList) [Optional] (a)

- nota: *at least one out of this attribute and "numberingOrg" should be set*

(XPath KnitClothOrder/KCCObody/KCCOitem/phase/garConsumptionSet/yarnCode/art/@codeList) [Optional]

- nota: *at least one out of this attribute and "numberingOrg" should be set*

(XPath KnitClothOrder/KCCObody/KCCOitem/garTecSheet/garConsumptionSet/texCode/art/@codeList) [Optional]

- nota: *at least one out of this attribute and "numberingOrg" should be set*

(XPath KnitClothOrder/KCCObody/KCCOitem/phase/garConsumptionSet/garmentPartCode/size/@codeList) [Optional]

(XPath KnitClothOrder/KCCObody/KCCOitem/apparelComponent/fabricComponent/texCode/pattern/@codeList) [Optional]

- nota: *at least one out of this attribute and "numberingOrg" should be set*

(XPath KnitClothOrder/KCCObody/KCCOitem/garTecSheet/garConsumptionSet/garmentCode/garmentCodeB/size/@codeList) [Optional]

(XPath KnitClothOrder/KCCObody/KCCOitem/phase/lotDetails/csRange/drop/@codeList) [Optional]

	<p>(XPath  KnitClothOrder/KCCObody/KCCOitem/phase/garConsumptionSet/garmentP  artCode/color/@codeList) [Optional]  - nota: <i>this attribute should be used either single or coupled with "listName"  and "listVersion"</i></p> <p>(XPath KnitClothOrder/KCCObody/KCCOitem/garTecSheet/  refDoc/season/@codeList) [Optional] (a)  - nota: <i>this attribute should be used either single or coupled with "listName"  and "listVersion"</i></p> <p>(XPath  KnitClothOrder/KCCObody/KCCOitem/phase/garConsumptionSet/garmentC  ode/garmentCodeB/mod/@codeList) [Optional]  - nota: <i>at least one out of this attribute and "numberingOrg" should be set</i>  (XPath KnitClothOrder/KCCObody/KCCOitem/progress/  qualityLevel/@codeList) [Optional]  - nota: <i>at least one out of this attribute and "numberingOrg" should be set</i>  (XPath KnitClothOrder/KCCObody/KCCOitem/garTecSheet/  garConsumptionSet/texCode/color/@codeList) [Optional]  - nota: <i>this attribute should be used either single or coupled with "listName"  and "listVersion"</i></p> <p>(XPath KnitClothOrder/KCCObody/KCCOitem/garTecSheet/  garConsumptionSet/texCode/pattern/@codeList) [Optional]  - nota: <i>at least one out of this attribute and "numberingOrg" should be set</i>  (XPath KnitClothOrder/KCCObody/KCCOitem/garTecSheet/  garConsumptionSet/garmentCode/garmentCodeB/artGroup/@codeList) [Opti  onal]  - nota: <i>at least one out of this attribute and "numberingOrg" should be set</i>  (XPath KnitClothOrder/KCCObody/KCCOitem/apparelComponent/  fabricComponent/texCode/color/@codeList) [Optional]  - nota: <i>this attribute should be used either single or coupled with "listName"  and "listVersion"</i></p> <p>(XPath  KnitClothOrder/KCCObody/KCCOitem/phase/garConsumptionSet/garmentP  artCode/fabric/@codeList) [Optional]  - nota: <i>at least one out of this attribute and "numberingOrg" should be set</i>  (XPath KnitClothOrder/KCCObody/KCCOitem/garTecSheet/  garConsumptionSet/acsCode/pattern/@codeList) [Optional]  - nota: <i>at least one out of this attribute and "numberingOrg" should be set</i>  (XPath  KnitClothOrder/KCCObody/KCCOitem/phase/garConsumptionSet/yarnCode/  color/@codeList) [Optional]  - nota: <i>this attribute should be used either single or coupled with "listName"  and "listVersion"</i></p> <p>(XPath KnitClothOrder/KCCObody/KCCOitem/garTecSheet/  garConsumptionSet/acsCode/color/@codeList) [Optional]  - nota: <i>this attribute should be used either single or coupled with "listName"  and "listVersion"</i></p> <p>(XPath KnitClothOrder/KCCObody/KCCOitem/apparelComponent/  yarnComponent/note/@codeList) [Optional]  - nota: <i>must be used to provide (URL) the list of codes used in "noteLabel"</i>  (XPath KnitClothOrder/KCCObody/KCCOitem/garTecSheet/  garConsumptionSet/acsCode/art/@codeList) [Optional]  - nota: <i>at least one out of this attribute and "numberingOrg" should be set</i>  (XPath KnitClothOrder/KCCObody/KCCOitem/garTecSheet/  garConsumptionSet/garmentCode/garmentCodeB/drop/@codeList) [Optional  ]  (XPath KnitClothOrder/KCCObody/KCCOitem/phase/lotDetails/  csRange/sizeMatrix/sizeRow/additionalComponentCode/@codeList) [Option  al] (a)  - nota: <i>at least one out of this attribute and "numberingOrg" should be set</i>  (XPath KnitClothOrder/KCCObody/KCCOitem/apparelComponent/  fabricComponent/texCode/art/@codeList) [Optional]  - nota: <i>at least one out of this attribute and "numberingOrg" should be set</i>  (XPath KnitClothOrder/KCCObody/KCCOitem/phase/lotDetails/  csRange/sizeMatrix/sizeRow/drop/@codeList) [Optional]</p>
--	---



(XPath KnitClothOrder/KCCObody/KCCOitem/garTecSheet/garSizeSet/garSizeTier/garSizeCode/@codeList) [Optional] (a)

- nota: *at least one out of this attribute and "numberingOrg" should be set*

(XPath KnitClothOrder/KCCOheader/refDoc/season/@codeList) [Optional] (a)

- nota: *this attribute should be used either single or coupled with "listName" and "listVersion"*

(XPath KnitClothOrder/KCCObody/KCCOitem/phase/garConsumptionSet/acsCode/art/@codeList) [Optional]

- nota: *at least one out of this attribute and "numberingOrg" should be set*

(XPath KnitClothOrder/KCCObody/KCCOitem/garTecSheet/garMeaSet/garMea/size/@codeList) [Optional]

(XPath KnitClothOrder/KCCObody/KCCOitem/phase/garConsumptionSet/garmentPartCode/mod/@codeList) [Optional]

- nota: *at least one out of this attribute and "numberingOrg" should be set*

(XPath KnitClothOrder/KCCObody/KCCOitem/garTecSheet/garConsumptionSet/garmentPartCode/mod/@codeList) [Optional]

- nota: *at least one out of this attribute and "numberingOrg" should be set*

(XPath KnitClothOrder/KCCObody/KCCOitem/garTecSheet/garmentCode/garmentCodeB/garmentVariant/variantType/@codeList) [Optional] (a)

- nota: *always at least one out of this attribute and "numberingOrg" should be set*

(XPath KnitClothOrder/KCCObody/KCCOitem/phase/garConsumptionSet/garmentCode/garmentCodeB/garmentVariant/variantType/@codeList) [Optional] (a)

- nota: *always at least one out of this attribute and "numberingOrg" should be set*

(XPath KnitClothOrder/KCCObody/KCCOitem/phase/garConsumptionSet/texCode/pattern/@codeList) [Optional]

- nota: *at least one out of this attribute and "numberingOrg" should be set*

(XPath KnitClothOrder/KCCObody/KCCOitem/phase/garConsumptionSet/texCode/color/@codeList) [Optional]

- nota: *this attribute should be used either single or coupled with "listName" and "listVersion"*

(XPath KnitClothOrder/KCCObody/KCCOitem/garTecSheet/garmentCode/garmentCodeB/garmentVariant/variantCode/@codeList) [Optional] (a)

- nota: *at least one out of this attribute and "numberingOrg" should be set*

(XPath KnitClothOrder/KCCOheader/season/@codeList) [Optional] (a)

- nota: *this attribute should be used either single or coupled with "listName" and "listVersion"*

(XPath KnitClothOrder/KCCObody/KCCOitem/phase/garConsumptionSet/garmentCode/garmentCodeB/garmentVariant/variantCode/@codeList) [Optional] (a)

- nota: *at least one out of this attribute and "numberingOrg" should be set*

(XPath KnitClothOrder/KCCObody/KCCOitem/garTecSheet/garmentCode/garmentCodeB/mod/@codeList) [Optional]

- nota: *at least one out of this attribute and "numberingOrg" should be set*

(XPath KnitClothOrder/KCCObody/KCCOitem/phase/garConsumptionSet/garmentCode/garmentCodeB/drop/@codeList) [Optional]

(XPath KnitClothOrder/KCCObody/KCCOitem/garTecSheet/garmentCode/garmentCodeB/fabric/@codeList) [Optional]

- nota: *at least one out of this attribute and "numberingOrg" should be set*

(XPath KnitClothOrder/KCCObody/KCCOitem/garTecSheet/garConsumptionSet/garmentCode/garmentCodeA/art/@codeList) [Optional]

- nota: *at least one out of this attribute and "numberingOrg" should be set*

(XPath KnitClothOrder/KCCObody/KCCOitem/apparelComponent/fabricComponent/refDoc/season/@codeList) [Optional] (a)

- nota: *this attribute should be used either single or coupled with "listName" and "listVersion"*

(XPath KnitClothOrder/KCCObody/KCCOitem/garTecSheet/  
garmentCode/garmentCodeB/color/@codeList) [Optional]  
- nota: *this attribute should be used either single or coupled with "listName" and "listVersion"*

(XPath KnitClothOrder/KCCObody/KCCOitem/garTecSheet/  
garConsumptionSet/garmentCode/garmentCodeB/garmentVariant/variantCode/@codeList) [Optional] (a)  
- nota: *at least one out of this attribute and "numberingOrg" should be set*

(XPath KnitClothOrder/KCCObody/KCCOitem/phase/garConsumptionSet/garmentCode/garmentCodeB/fabric/@codeList) [Optional]  
- nota: *at least one out of this attribute and "numberingOrg" should be set*

(XPath KnitClothOrder/KCCObody/KCCOitem/garTecSheet/  
garConsumptionSet/yarnCode/art/@codeList) [Optional]  
- nota: *at least one out of this attribute and "numberingOrg" should be set*

(XPath KnitClothOrder/KCCObody/KCCOitem/garTecSheet/  
garConsumptionSet/yarnCode/color/@codeList) [Optional]  
- nota: *this attribute should be used either single or coupled with "listName" and "listVersion"*

(XPath KnitClothOrder/KCCObody/KCCOitem/garTecSheet/  
garmentCode/garmentCodeA/art/@codeList) [Optional]  
- nota: *at least one out of this attribute and "numberingOrg" should be set*

(XPath KnitClothOrder/KCCObody/KCCOitem/phase/lotDetails/  
csRange/sizeMatrix/sizeRow/size/@codeList) [Optional]  
(XPath KnitClothOrder/KCCObody/KCCOitem/phase/lotDetails/  
csRange/garmentVariant/variantCode/@codeList) [Optional] (a)  
- nota: *at least one out of this attribute and "numberingOrg" should be set*

(XPath KnitClothOrder/KCCObody/KCCOitem/phase/lotDetails/  
csRange/garmentVariant/variantType/@codeList) [Optional] (a)  
- nota: *always at least one out of this attribute and "numberingOrg" should be set*

(XPath KnitClothOrder/KCCObody/KCCOitem/garTecSheet/  
garmentCode/garmentCodeB/size/@codeList) [Optional]  
(XPath KnitClothOrder/KCCObody/KCCOitem/phase/garConsumptionSet/garmentCode/garmentCodeB/color/@codeList) [Optional]  
- nota: *this attribute should be used either single or coupled with "listName" and "listVersion"*

(XPath KnitClothOrder/KCCObody/KCCOitem/garTecSheet/  
garmentCode/garmentCodeB/drop/@codeList) [Optional]  
(XPath KnitClothOrder/KCCObody/KCCOitem/phase/lotDetails/  
csRange/color/@codeList) [Optional]  
- nota: *this attribute should be used either single or coupled with "listName" and "listVersion"*

(XPath KnitClothOrder/KCCObody/KCCOitem/apparelComponent/  
yarnComponent/refDoc/season/@codeList) [Optional] (a)  
- nota: *this attribute should be used either single or coupled with "listName" and "listVersion"*

(XPath KnitClothOrder/KCCObody/KCCOitem/apparelComponent/  
fabricComponent/itemsList/qualityLevel/@codeList) [Optional] (a)  
- nota: *at least one out of this attribute and "numberingOrg" should be set*

(XPath KnitClothOrder/KCCObody/KCCOitem/garTecSheet/  
garmentCode/garmentCodeB/artGroup/@codeList) [Optional]  
- nota: *at least one out of this attribute and "numberingOrg" should be set*

(XPath KnitClothOrder/KCCObody/KCCOitem/endUseGroup/  
csRange/sizeMatrix/sizeRow/additionalComponentCode/@codeList) [Optional] (a)  
- nota: *at least one out of this attribute and "numberingOrg" should be set*

(XPath KnitClothOrder/KCCObody/KCCOitem/apparelProd/  
garmentPartCode/color/@codeList) [Optional]  
- nota: *this attribute should be used either single or coupled with "listName" and "listVersion"*

(XPath KnitClothOrder/KCCObody/KCCOitem/phase/note/@codeList) [Optional]  
- nota: *must be used to provide (URL) the list of codes used in "noteLabel"*

	<p>(XPath KnitClothOrder/KCCObody/KCCOitem/apparelComponent/garmentPartComponent/refDoc/season/@codeList) [Optional] (a)</p> <p>- nota: <i>this attribute should be used either single or coupled with "listName" and "listVersion"</i></p> <p>(XPath KnitClothOrder/KCCObody/KCCOitem/apparelProd/garmentPartCode/size/@codeList) [Optional]</p> <p>(XPath KnitClothOrder/KCCObody/KCCOitem/dtScheme/legalRef/@codeList) [Optional] (a)</p> <p>(XPath KnitClothOrder/KCCObody/KCCOitem/garComInfo/brand/@codeList) [Optional] (a)</p> <p>- nota: <i>at least one out of this attribute and "numberingOrg" should be set</i></p> <p>(XPath KnitClothOrder/KCCObody/KCCOitem/garComInfo/productLine/@codeList) [Optional]</p> <p>- nota: <i>at least one out of this attribute and "numberingOrg" should be set</i></p> <p>(XPath KnitClothOrder/KCCObody/KCCOitem/apparelProd/garmentPartCode/mod/@codeList) [Optional]</p> <p>- nota: <i>at least one out of this attribute and "numberingOrg" should be set</i></p> <p>(XPath KnitClothOrder/KCCObody/KCCOitem/apparelProd/garmentPartCode/fabric/@codeList) [Optional]</p> <p>- nota: <i>at least one out of this attribute and "numberingOrg" should be set</i></p> <p>(XPath KnitClothOrder/KCCObody/KCCOitem/garComInfo/season/@codeList) [Optional] (a)</p> <p>- nota: <i>this attribute should be used either single or coupled with "listName" and "listVersion"</i></p> <p>(XPath KnitClothOrder/KCCObody/KCCOitem/endUseGroup/csRange/sizeMatrix/sizeRow/drop/@codeList) [Optional]</p> <p>(XPath KnitClothOrder/KCCObody/KCCOitem/apparelProd/garmentCode/garmentCodeB/garmentVariant/variantType/@codeList) [Optional] (a)</p> <p>- nota: <i>always at least one out of this attribute and "numberingOrg" should be set</i></p> <p>(XPath KnitClothOrder/KCCOheader/note/@codeList) [Optional]</p> <p>- nota: <i>must be used to provide (URL) the list of codes used in "noteLabel"</i></p> <p>(XPath KnitClothOrder/KCCObody/KCCOitem/appMnfrOperation/refDoc/season/@codeList) [Optional] (a)</p> <p>- nota: <i>this attribute should be used either single or coupled with "listName" and "listVersion"</i></p> <p>(XPath KnitClothOrder/KCCObody/KCCOitem/apparelProd/garmentCode/garmentCodeB/garmentVariant/variantCode/@codeList) [Optional] (a)</p> <p>- nota: <i>at least one out of this attribute and "numberingOrg" should be set</i></p> <p>(XPath KnitClothOrder/KCCObody/KCCOitem/phase/packages/handlingChar/garPack/garPackCode/@codeList) [Optional] (a)</p> <p>- nota: <i>at least one out of this attribute and "numberingOrg" should be set</i></p> <p>(XPath KnitClothOrder/KCCObody/KCCOitem/apparelProd/garmentCode/garmentCodeB/color/@codeList) [Optional]</p> <p>- nota: <i>this attribute should be used either single or coupled with "listName" and "listVersion"</i></p> <p>(XPath KnitClothOrder/KCCObody/KCCOitem/phase/packages/handlingChar/note/@codeList) [Optional]</p> <p>- nota: <i>must be used to provide (URL) the list of codes used in "noteLabel"</i></p> <p>(XPath KnitClothOrder/KCCObody/KCCOitem/apparelComponent/acsComponent/refDoc/season/@codeList) [Optional] (a)</p> <p>- nota: <i>this attribute should be used either single or coupled with "listName" and "listVersion"</i></p> <p>(XPath KnitClothOrder/KCCObody/KCCOitem/apparelProd/garmentCode/garmentCodeB/mod/@codeList) [Optional]</p> <p>- nota: <i>at least one out of this attribute and "numberingOrg" should be set</i></p> <p>(XPath KnitClothOrder/KCCObody/KCCOitem/endUseGroup/csRange/sizeMatrix/sizeRow/size/@codeList) [Optional]</p> <p>(XPath KnitClothOrder/KCCObody/KCCOitem/apparelProd/garmentCode/garmentCodeB/fabric/@codeList) [Optional]</p> <p>- nota: <i>at least one out of this attribute and "numberingOrg" should be set</i></p> <p>(XPath KnitClothOrder/KCCObody/KCCOitem/endUseGroup/csRange/drop/@codeList) [Optional]</p>
--	---

(XPath KnitClothOrder/terms/allowanceCharge/dtScheme/legalRef/@codeList) [Optional]

(XPath KnitClothOrder/KCCObody/KCCOitem/dtScheme/note/@codeList) [Optional]

- nota: *must be used to provide (URL) the list of codes used in "noteLabel"*

(XPath KnitClothOrder/KCCObody/KCCOitem/garComInfo/garPack/garPackCode/@codeList) [Optional] (a)

- nota: *at least one out of this attribute and "numberingOrg" should be set*

(XPath KnitClothOrder/KCCObody/KCCOitem/apparelComponent/garmentPartComponent/note/@codeList) [Optional]

- nota: *must be used to provide (URL) the list of codes used in "noteLabel"*

(XPath KnitClothOrder/garComInfo/productLine/@codeList) [Optional] (a)

- nota: *at least one out of this attribute and "numberingOrg" should be set*

(XPath KnitClothOrder/garComInfo/brand/@codeList) [Optional] (a)

- nota: *at least one out of this attribute and "numberingOrg" should be set*

(XPath KnitClothOrder/KCCObody/KCCOitem/garComInfo/note/@codeList) [Optional]

- nota: *must be used to provide (URL) the list of codes used in "noteLabel"*

(XPath KnitClothOrder/terms/allowanceCharge/dtScheme/note/@codeList) [Optional]

- nota: *must be used to provide (URL) the list of codes used in "noteLabel"*

(XPath KnitClothOrder/garComInfo/season/@codeList) [Optional] (a)

- nota: *this attribute should be used either single or coupled with "listName" and "listVersion"*

(XPath KnitClothOrder/KCCObody/KCCOitem/apparelComponent/acsComponent/acsCode/art/@codeList) [Optional]

- nota: *at least one out of this attribute and "numberingOrg" should be set*

(XPath KnitClothOrder/KCCObody/KCCOitem/apparelComponent/acsComponent/acsCode/pattern/@codeList) [Optional]

- nota: *at least one out of this attribute and "numberingOrg" should be set*

(XPath KnitClothOrder/garComInfo/operationalCode/@codeList) [Optional] (a)

- nota: *at least one out of this attribute and "numberingOrg" should be set*

(XPath KnitClothOrder/garComInfo/garPack/garPackCode/@codeList) [Optional] (a)

- nota: *at least one out of this attribute and "numberingOrg" should be set*

(XPath KnitClothOrder/KCCObody/KCCOitem/garComInfo/operationalCode/@codeList) [Optional]

- nota: *at least one out of this attribute and "numberingOrg" should be set*

(XPath KnitClothOrder/KCCObody/KCCOitem/endUseGroup/csRange/garmentVariant/variantCode/@codeList) [Optional] (a)

- nota: *at least one out of this attribute and "numberingOrg" should be set*

(XPath KnitClothOrder/garComInfo/note/@codeList) [Optional]

- nota: *must be used to provide (URL) the list of codes used in "noteLabel"*

(XPath KnitClothOrder/KCCObody/KCCOitem/note/@codeList) [Optional]

- nota: *must be used to provide (URL) the list of codes used in "noteLabel"*

(XPath KnitClothOrder/KCCObody/KCCOitem/apparelComponent/acsComponent/note/@codeList) [Optional]

- nota: *must be used to provide (URL) the list of codes used in "noteLabel"*

(XPath KnitClothOrder/KCCObody/KCCOitem/endUseGroup/csRange/color/@codeList) [Optional]

- nota: *this attribute should be used either single or coupled with "listName" and "listVersion"*

(XPath KnitClothOrder/KCCObody/KCCOitem/garComInfo/acsPack/acsPackCode/@codeList) [Optional] (a)

- nota: *at least one out of this attribute and "numberingOrg" should be set*

(XPath KnitClothOrder/KCCObody/KCCOitem/endUseGroup/csRange/garmentVariant/variantType/@codeList) [Optional] (a)

- nota: *always at least one out of this attribute and "numberingOrg" should be set*

(XPath KnitClothOrder/garComInfo/acsPack/acsPackCode/@codeList) [Optional] (a)

- nota: *at least one out of this attribute and "numberingOrg" should be set*

(XPath KnitClothOrder/KCCObody/KCCOitem/apparelComponent/acsComponent/acsCode/color/@codeList) [Optional]

- nota: *this attribute should be used either single or coupled with "listName" and "listVersion"*

(XPath KnitClothOrder/KCCObody/KCCOitem/phase/packages/handlingChar/acsPack/acsPackCode/@codeList) [Optional] (a)

	<p>- nota: <i>at least one out of this attribute and "numberingOrg" should be set</i> (XPath KnitClothOrder/KCCObody/KCCOitem/apparelProd/ garmentCode/garmentCodeA/art/@codeList) [Optional]</p> <p>- nota: <i>at least one out of this attribute and "numberingOrg" should be set</i> (XPath KnitClothOrder/KCCObody/KCCOitem/apparelProd/ garmentCode/garmentCodeB/size/@codeList) [Optional]</p> <p>(XPath KnitClothOrder/KCCObody/KCCOitem/apparelComponent/ garmentPartComponent/garmentPartCode/color/@codeList) [Optional]</p> <p>- nota: <i>this attribute should be used either single or coupled with "listName" and "listVersion"</i> (XPath KnitClothOrder/KCCObody/KCCOitem/apparelProd/ garmentCode/garmentCodeB/drop/@codeList) [Optional]</p> <p>(XPath KnitClothOrder/KCCObody/KCCOitem/endUseGroup/ csRange/sizeMatrix/sizeRow/itemsList/qualityLevel/@codeList) [Optional] (a)</p> <p>- nota: <i>at least one out of this attribute and "numberingOrg" should be set</i> (XPath KnitClothOrder/KCCObody/KCCOitem/packages/ handlingChar/acsPack/acsPackCode/@codeList) [Optional] (a)</p> <p>- nota: <i>at least one out of this attribute and "numberingOrg" should be set</i> (XPath KnitClothOrder/KCCObody/KCCOitem/apparelComponent/ garmentPartComponent/garmentPartCode/size/@codeList) [Optional]</p> <p>(XPath KnitClothOrder/KCCObody/KCCOitem/packages/ handlingChar/garPack/garPackCode/@codeList) [Optional] (a)</p> <p>- nota: <i>at least one out of this attribute and "numberingOrg" should be set</i> (XPath KnitClothOrder/KCCObody/KCCOitem/apparelProd/ garmentCode/garmentCodeB/artGroup/@codeList) [Optional]</p> <p>- nota: <i>at least one out of this attribute and "numberingOrg" should be set</i></p>
@codeQualifier	<p>operational code qualifier: it states if the code is related to a project, an event, an initiative, a sales channel, a management type (eg CITES), .....</p> <p>- base type: string, cod. table: NT43 <a href="http://www.ebiz.enea.it/moda-ml/repository/codelist/v2018-1/gc_NT43.xml">http://www.ebiz.enea.it/moda-ml/repository/codelist/v2018-1/gc_NT43.xml</a></p> <p>(XPath KnitClothOrder/garComInfo/operationalCode/@codeQualifier) [Optional] (Na)</p> <p>(XPath KnitClothOrder/KCCObody/KCCOitem/garComInfo/ operationalCode/@codeQualifier) [Optional] (N)</p>
color	<p>colour number of the product, when not included in the model or fabric code</p> <p>- base type: string, max length: 15, (XPath KnitClothOrder/KCCObody/KCCOitem/garTecSheet/ garConsumptionSet/garmentCode/garmentCodeB/color) 0-1</p> <p>(XPath KnitClothOrder/KCCObody/KCCOitem/apparelProd/ csRange/color) 0-1</p> <p>- note: <i>used only if not already specified in the article code</i> (XPath KnitClothOrder/KCCObody/KCCOitem/apparelComponent/ yarnComponent/yarnCode/color) 0-1</p> <p>(XPath KnitClothOrder/KCCObody/KCCOitem/apparelComponent/ acsComponent/acsCode/color) 0-1</p> <p>(XPath KnitClothOrder/KCCObody/KCCOitem/garTecSheet/ garConsumptionSet/texCode/color) 0-1</p> <p>(XPath KnitClothOrder/KCCObody/KCCOitem/garTecSheet/ garConsumptionSet/yarnCode/color) 0-1</p> <p>(XPath KnitClothOrder/KCCObody/KCCOitem/garTecSheet/ garConsumptionSet/acsCode/color) 0-1</p> <p>(XPath KnitClothOrder/KCCObody/KCCOitem/phase/garConsumptionSet/garmentCode/garmentCodeB/color) 0-1</p> <p>(XPath KnitClothOrder/KCCObody/KCCOitem/phase/lotDetails/ csRange/color) 0-1</p> <p>- note: <i>used only if not already specified in the article code</i> (XPath KnitClothOrder/KCCObody/KCCOitem/apparelComponent/ fabricComponent/texCode/color) 0-1</p> <p>(XPath KnitClothOrder/KCCObody/KCCOitem/apparelProd/ garmentPartCode/color) 0-1</p> <p>- note: <i>when a garment component, it should be the code assigned to the garment article</i> (XPath KnitClothOrder/KCCObody/KCCOitem/phase/garConsumptionSet/garmentPartCode/color) 0-1</p>



	<p>- note: <i>when a garment component, it should be the code assigned to the garment article</i>  (XPath KnitClothOrder/KCCObody/KCCOitem/phase/garConsumptionSet/texCode/color) 0-1  (XPath KnitClothOrder/KCCObody/KCCOitem/garTecSheet/garmentCode/garmentCodeB/color) 0-1  (XPath KnitClothOrder/KCCObody/KCCOitem/phase/garConsumptionSet/yarnCode/color) 0-1  (XPath KnitClothOrder/KCCObody/KCCOitem/apparelComponent/garmentPartComponent/garmentPartCode/color) 0-1</p> <p>- note: <i>when a garment component, it should be the code assigned to the garment article</i>  (XPath KnitClothOrder/KCCObody/KCCOitem/apparelProd/garmentCode/garmentCodeB/color) 0-1  (XPath KnitClothOrder/KCCObody/KCCOitem/garTecSheet/garConsumptionSet/garmentPartCode/color) 0-1</p> <p>- note: <i>when a garment component, it should be the code assigned to the garment article</i>  (XPath KnitClothOrder/KCCObody/KCCOitem/phase/garConsumptionSet/acsCode/color) 0-1  (XPath KnitClothOrder/KCCObody/KCCOitem/endUseGroup/csRange/color) 0-1</p> <p>- note: <i>used only if not already specified in the article code</i></p>
@consumptionType	<p>indicates what the indicated quantity is referred to (for example, required quantity for unit of product -BoM- or required quantity to obtain the indicated total amount of product -BoL-)  - base type: string, cod. table: NT39  <a href="http://www.ebiz.enea.it/moda-ml/repository/codelist/v2018-1/gc_NT39.xml">http://www.ebiz.enea.it/moda-ml/repository/codelist/v2018-1/gc_NT39.xml</a>  (XPath KnitClothOrder/KCCObody/KCCOitem/phase/garConsumptionSet/garConsumption/@consumptionType) [Optional] (Na)  (XPath KnitClothOrder/KCCObody/KCCOitem/garTecSheet/garConsumptionSet/garConsumption/@consumptionType) [Optional] (Na)</p>
country	<p>code of the nation  - base type: string, cod. table: T10  <a href="http://www.ebiz.enea.it/moda-ml/repository/codelist/v2018-1/gc_T10.xml">http://www.ebiz.enea.it/moda-ml/repository/codelist/v2018-1/gc_T10.xml</a>  (XPath KnitClothOrder/KCCObody/KCCOitem/phase/thirdParty/country) 0-1  (XPath KnitClothOrder/KCCObody/KCCOitem/thirdParty/country) 0-1  (XPath KnitClothOrder/KCCOheader/thirdParty/country) 0-1  (XPath KnitClothOrder/KCCOheader/buyer/country) 0-1  (XPath KnitClothOrder/KCCOheader/subContractor/country) 0-1</p>
@CQQ	<p>specifies if the committed quantity can or can not include the loss in weight  - base type: string, cod. table: NT37  <a href="http://www.ebiz.enea.it/moda-ml/repository/codelist/v2018-1/gc_NT37.xml">http://www.ebiz.enea.it/moda-ml/repository/codelist/v2018-1/gc_NT37.xml</a>  (XPath KnitClothOrder/KCCObody/KCCOitem/apparelComponent/yarnComponent/@CQQ) [Optional]</p>
criticalityIndicator	<p>criticality indicator (it can be "true" or "false": true = criticality, false = non criticality)  - base type: boolean,  (XPath KnitClothOrder/KCCObody/KCCOitem/phase/criticalityIndicator) 0-1 (N)</p>
@currency	<p>currency in which a specified monetary data is expressed  - base type: string, cod. table: T9  <a href="http://www.ebiz.enea.it/moda-ml/repository/codelist/v2018-1/gc_T9.xml">http://www.ebiz.enea.it/moda-ml/repository/codelist/v2018-1/gc_T9.xml</a>  (XPath KnitClothOrder/terms/allowanceCharge/@currency) [Optional] (a)  (XPath KnitClothOrder/KCCObody/KCCOitem/phase/price/@currency) [Optional] (a)  - nota: <i>Currency referred by the price.</i>  (XPath KnitClothOrder/KCCObody/KCCOitem/price/@currency) [Optional] (a)  - nota: <i>Currency referred by the price.</i></p>

	(XPath KnitClothOrder/terms/allowanceCharge/AC_amount/@currency) [Optional] (a)
customsStat	statistic code assigned by Customs to a specified product - base type: string, max length: 15, (XPath KnitClothOrder/KCCObody/KCCOitem/garTecSheet/customsStat) 0-1
@CV	coefficient of variation (CV) of a measurement - base type: decimal, (XPath KnitClothOrder/KCCObody/KCCOitem/garTecSheet/garMeaSet/garMea/specValue/@CV) [Optional]
@dateForm	format used for the date - base type: string, cod. table: NT29 <a href="http://www.ebiz.enea.it/moda-ml/repository/codelist/v2018-1/gc_NT29.xml">http://www.ebiz.enea.it/moda-ml/repository/codelist/v2018-1/gc_NT29.xml</a> (XPath KnitClothOrder/KCCObody/KCCOitem/apparelComponent/yarnComponent/refDoc/docDate/@dateForm) [Optional] (XPath KnitClothOrder/KCCObody/KCCOitem/phase/notBeforeDate/@dateForm) [Optional] (XPath KnitClothOrder/KCCObody/KCCOitem/garComInfo/specDate/@dateForm) [Optional] (XPath KnitClothOrder/garComInfo/deliveryDate/@dateForm) [Optional] (XPath KnitClothOrder/KCCOheader/refDoc/docDate/@dateForm) [Optional] (XPath KnitClothOrder/KCCObody/KCCOitem/garTecSheet/refDoc/docDate/@dateForm) [Optional] (XPath KnitClothOrder/terms/transInfo/despatchDate/@dateForm) [Optional] (a) (XPath KnitClothOrder/KCCObody/KCCOitem/garComInfo/deliveryDate/@dateForm) [Optional] (XPath KnitClothOrder/KCCObody/KCCOitem/phase/refDoc/docDate/@dateForm) [Optional] (XPath KnitClothOrder/KCCObody/KCCOitem/appMnfrOperation/refDoc/docDate/@dateForm) [Optional] (XPath KnitClothOrder/KCCObody/KCCOitem/progress/deliveryDate/@dateForm) [Optional] (XPath KnitClothOrder/KCCObody/KCCOitem/progress/delGrantedDate/@dateForm) [Optional] (XPath KnitClothOrder/garComInfo/specDate/@dateForm) [Optional] (XPath KnitClothOrder/KCCOheader/msgDate/@dateForm) [Optional] (XPath KnitClothOrder/KCCOheader/validityStart/@dateForm) [Optional] (XPath KnitClothOrder/KCCOheader/validityEnd/@dateForm) [Optional] (XPath KnitClothOrder/KCCObody/KCCOitem/apparelComponent/garmentPartComponent/refDoc/docDate/@dateForm) [Optional] (XPath KnitClothOrder/terms/transInfo/delEffectiveDate/@dateForm) [Optional] (XPath KnitClothOrder/KCCObody/KCCOitem/apparelComponent/acsComponent/refDoc/docDate/@dateForm) [Optional] (XPath KnitClothOrder/KCCObody/KCCOitem/apparelComponent/fabricComponent/refDoc/docDate/@dateForm) [Optional] (XPath KnitClothOrder/KCCObody/KCCOitem/deliveryDate/@dateForm) [Optional] (XPath KnitClothOrder/KCCObody/KCCOitem/phase/delGrantedDate/@dateForm) [Optional] (XPath KnitClothOrder/KCCObody/KCCOitem/phase/deliveryDate/@dateForm) [Optional]
delEffectiveDate	effective date of delivery of goods (declared in Despatch), according to one of the patterns YYYY-MM-DD, YYYY-MM-DD:HH-MM or YYYY-WW. - base type: string, (XPath KnitClothOrder/terms/transInfo/delEffectiveDate) 0-1 (p)
delGrantedDate	effective granted date of delivery of goods; in case of doubt delivery must be understood as the event when the ownership of goods is transferred, according to one of the patterns YYYY-MM-DD, YYYY-MM-DD:HH-MM or YYYY-WW. - base type: string, (XPath KnitClothOrder/KCCObody/KCCOitem/phase/delGrantedDate) 0-1 (p)

	(XPath KnitClothOrder/KCCObody/KCCOitem/progress/delGrantedDate) 0-1
deliveryDate	<p>date of delivery of goods, requested or promised in the purchase process, according to one of the patterns YYYY-MM-DD, YYYY-MM-DD:HH-MM or YY YY-WW.</p> <p>- base type: string,</p> <p>(XPath KnitClothOrder/KCCObody/KCCOitem/garComInfo/deliveryDate) 0-1 (p)</p> <p>(XPath KnitClothOrder/KCCObody/KCCOitem/phase/deliveryDate) 0-1</p> <p>(XPath KnitClothOrder/KCCObody/KCCOitem/progress/deliveryDate) 0-1</p> <p>(XPath KnitClothOrder/garComInfo/deliveryDate) 0-1 (p)</p> <p>(XPath KnitClothOrder/KCCObody/KCCOitem/deliveryDate) 0-1</p> <p>- note: <i>Delivery date should not be used here when the garComInfo.element is used.</i></p>
deliveryPlace	<p>place of delivery of goods, ultimate or related to a given leg</p> <p>- base type: string, max length: 250,</p> <p>(XPath KnitClothOrder/terms/transInfo/deliveryPlace) 0-1 (U)</p>
dept	<p>name or code of a contact department within a Party</p> <p>- base type: string, max length: 40,</p> <p>(XPath KnitClothOrder/KCCOheader/subContractor/dept) 0-1</p> <p>(XPath KnitClothOrder/KCCObody/KCCOitem/thirdParty/dept) 0-1</p> <p>(XPath KnitClothOrder/KCCOheader/thirdParty/dept) 0-1</p> <p>(XPath KnitClothOrder/KCCOheader/buyer/dept) 0-1</p> <p>(XPath KnitClothOrder/KCCObody/KCCOitem/phase/thirdParty/dept) 0-1</p>
description	<p>free text description. The content of the element must be unique, it might be translated and repeated into more languages (thus no more than one instance for each language).</p> <p>- base type: string, max length: 250,</p> <p>(XPath KnitClothOrder/KCCObody/KCCOitem/phase/garConsumptionSet/garmentPartCode/description) 0-unbounded (AU)</p> <p>- note: <i>Product part description</i></p> <p>(XPath KnitClothOrder/KCCObody/KCCOitem/garTecSheet/garmentCode/garmentCodeA/description) 0-unbounded (AU)</p> <p>- note: <i>Product description</i></p> <p>(XPath KnitClothOrder/KCCObody/KCCOitem/phase/garConsumptionSet/texCode/description) 0-unbounded (pAU)</p> <p>- note: <i>Product description</i></p> <p>(XPath KnitClothOrder/KCCObody/KCCOitem/apparelProd/garmentCode/garmentCodeB/description) 0-unbounded (AU)</p> <p>- note: <i>Product description</i></p> <p>(XPath KnitClothOrder/KCCObody/KCCOitem/apparelComponent/fabricComponent/texCode/description) 0-unbounded (pAU)</p> <p>- note: <i>Product description</i></p> <p>(XPath KnitClothOrder/KCCObody/KCCOitem/apparelProd/garmentCode/garmentCodeA/description) 0-unbounded (AU)</p> <p>- note: <i>Product description</i></p> <p>(XPath KnitClothOrder/KCCObody/KCCOitem/apparelComponent/garmentPartComponent/garmentPartCode/description) 0-unbounded (AU)</p> <p>- note: <i>Product part description</i></p> <p>(XPath KnitClothOrder/KCCObody/KCCOitem/garTecSheet/garConsumptionSet/texCode/description) 0-unbounded (pAU)</p> <p>- note: <i>Product description</i></p> <p>(XPath KnitClothOrder/KCCObody/KCCOitem/garTecSheet/garConsumptionSet/acsCode/description) 0-unbounded (AU)</p> <p>- note: <i>Product description</i></p> <p>(XPath KnitClothOrder/KCCObody/KCCOitem/garTecSheet/garConsumptionSet/yarnCode/description) 0-unbounded (AU)</p> <p>- note: <i>Product description</i></p> <p>(XPath KnitClothOrder/KCCObody/KCCOitem/phase/garConsumptionSet/garmentCode/garmentCodeB/description) 0-unbounded (AU)</p> <p>- note: <i>Product description</i></p>



	<p>(XPath KnitClothOrder/KCCObody/KCCOitem/phase/garConsumptionSet/garmentCode/garmentCodeA/description) 0-unbounded (AU)  - note: <i>Product description</i></p> <p>(XPath KnitClothOrder/KCCObody/KCCOitem/phase/garConsumptionSet/yarnCode/description) 0-unbounded (AU)  - note: <i>Product description</i></p> <p>(XPath KnitClothOrder/KCCObody/KCCOitem/garTecSheet/garConsumptionSet/garmentCode/garmentCodeA/description) 0-unbounded (AU)  - note: <i>Product description</i></p> <p>(XPath KnitClothOrder/KCCObody/KCCOitem/phase/packages/description) 0-unbounded (AU)  (XPath KnitClothOrder/KCCObody/KCCOitem/garTecSheet/garmentCode/garmentCodeB/description) 0-unbounded (AU)  - note: <i>Product description</i></p> <p>(XPath KnitClothOrder/KCCObody/KCCOitem/phase/garConsumptionSet/acsCode/description) 0-unbounded (AU)  - note: <i>Product description</i></p> <p>(XPath KnitClothOrder/KCCObody/KCCOitem/apparelComponent/yarnComponent/yarnCode/description) 0-unbounded (AU)  - note: <i>Product description</i></p> <p>(XPath KnitClothOrder/KCCObody/KCCOitem/apparelComponent/acsComponent/acsCode/description) 0-unbounded (AU)  - note: <i>Product description</i></p> <p>(XPath KnitClothOrder/KCCObody/KCCOitem/garTecSheet/garConsumptionSet/garmentPartCode/description) 0-unbounded (AU)  - note: <i>Product part description</i></p> <p>(XPath KnitClothOrder/KCCObody/KCCOitem/packages/description) 0-unbounded (AU)  (XPath KnitClothOrder/KCCObody/KCCOitem/garTecSheet/garConsumptionSet/garmentCode/garmentCodeB/description) 0-unbounded (AU)  - note: <i>Product description</i></p> <p>(XPath KnitClothOrder/KCCObody/KCCOitem/apparelProd/garmentPartCode/description) 0-unbounded (AU)  - note: <i>Product part description</i></p>
despatchDate	<p>date of despatch of goods, requested or promised in the purchase process, according to one of the patterns YYYY-MM-DD, YYYY-MM-DD:HH-MM or YYY-WW.  - base type: string,  (XPath KnitClothOrder/terms/transInfo/despatchDate) 0-1 (N)</p>
despatchPlace	<p>place of despatch of goods, origin or related to a given leg  - base type: string, max length: 250,  (XPath KnitClothOrder/terms/transInfo/despatchPlace) 0-1 (N)</p>
docDate	<p>date of issue of the referenced document, according to one of the patterns YYYY-MM-DD, YYYY-MM-DD:HH-MM or YYYY-WW.  - base type: string,  (XPath KnitClothOrder/KCCObody/KCCOitem/apparelComponent/yarnComponent/refDoc/docDate) 0-1  (XPath KnitClothOrder/KCCOheader/refDoc/docDate) 0-1  (XPath KnitClothOrder/KCCObody/KCCOitem/apparelComponent/garmentPartComponent/refDoc/docDate) 0-1  (XPath KnitClothOrder/KCCObody/KCCOitem/garTecSheet/refDoc/docDate) 0-1  (XPath KnitClothOrder/KCCObody/KCCOitem/apparelComponent/fabricComponent/refDoc/docDate) 0-1  (XPath KnitClothOrder/KCCObody/KCCOitem/apparelComponent/acsComponent/refDoc/docDate) 0-1  (XPath KnitClothOrder/KCCObody/KCCOitem/appMnfrOperation/refDoc/docDate) 0-1</p>

	(XPath KnitClothOrder/KCCObody/KCCOitem/phase/refDoc/docDate) 0-1
docID	<p>identification number of the referenced document SINCE 2008-1 ITS USE I N THE HEADER IS DISCOURAGED (REPLACED BY msgID)</p> <p>- base type: string, max length: 80, (XPath KnitClothOrder/KCCOheader/docID) 0-1 (XPath KnitClothOrder/KCCObody/KCCOitem/phase/refDoc/docID) 1-2 (p)</p> <hr/> <p>AAAA-WARNING! - text not AVAILABLE n. 245 - In=en (XPath KnitClothOrder/KCCObody/KCCOitem/apparelComponent/acsComponent/refDoc/docID) 1-2 (p)</p> <hr/> <p>AAAA-WARNING! - text not AVAILABLE n. 245 - In=en (XPath KnitClothOrder/KCCObody/KCCOitem/apparelComponent/fabricComponent/refDoc/docID) 1-2 (p)</p> <hr/> <p>AAAA-WARNING! - text not AVAILABLE n. 245 - In=en (XPath KnitClothOrder/KCCObody/KCCOitem/appMnfrOperation/refDoc/docID) 1-2</p> <hr/> <p>AAAA-WARNING! - text not AVAILABLE n. 245 - In=en (XPath KnitClothOrder/KCCObody/KCCOitem/apparelComponent/garmentPartComponent/refDoc/docID) 1-2 (p)</p> <hr/> <p>AAAA-WARNING! - text not AVAILABLE n. 245 - In=en (XPath KnitClothOrder/KCCOheader/refDoc/docID) 1-2 (p)</p> <hr/> <p>AAAA-WARNING! - text not AVAILABLE n. 245 - In=en (XPath KnitClothOrder/KCCObody/KCCOitem/garTecSheet/refDoc/docID) 1-2</p> <hr/> <p>AAAA-WARNING! - text not AVAILABLE n. 245 - In=en (XPath KnitClothOrder/KCCObody/KCCOitem/apparelComponent/yarnComponent/refDoc/docID) 1-2 (p)</p> <hr/> <p>AAAA-WARNING! - text not AVAILABLE n. 245 - In=en</p>
@docType	<p>type or class to which the referenced document belongs</p> <p>- base type: string, cod. table: T21 <a href="http://www.ebiz.enea.it/moda-ml/repository/codelist/v2018-1/gc_T21.xml">http://www.ebiz.enea.it/moda-ml/repository/codelist/v2018-1/gc_T21.xml</a></p> <p>(XPath KnitClothOrder/KCCObody/KCCOitem/apparelComponent/acsComponent/refDoc/@docType) [Required] (XPath KnitClothOrder/KCCObody/KCCOitem/apparelComponent/fabricComponent/refDoc/@docType) [Required] (XPath KnitClothOrder/KCCObody/KCCOitem/apparelComponent/garmentPartComponent/refDoc/@docType) [Required] (XPath KnitClothOrder/KCCOheader/refDoc/@docType) [Required] (XPath KnitClothOrder/KCCObody/KCCOitem/appMnfrOperation/refDoc/@docType) [Required] (XPath KnitClothOrder/KCCObody/KCCOitem/phase/refDoc/@docType) [Required] (XPath KnitClothOrder/KCCObody/KCCOitem/garTecSheet/refDoc/@docType) [Required] (XPath KnitClothOrder/KCCObody/KCCOitem/apparelComponent/yarnComponent/refDoc/@docType) [Required]</p>
drop	<p>drop number of the garment</p> <p>- base type: string, max length: 15, (XPath KnitClothOrder/KCCObody/KCCOitem/garTecSheet/garmentCode/garmentCodeB/drop) 0-1 (A)</p> <p>- note: <i>Fill this element if the drop is the same for all the sizes of the model. Otherway specify it within the csRange element</i> (XPath KnitClothOrder/KCCObody/KCCOitem/endUseGroup/csRange/drop) 0-1 (A)</p> <p>- note: <i>used only if not already specified in the article code</i> (XPath KnitClothOrder/KCCObody/KCCOitem/phase/garConsumptionSet/garmentCode/garmentCodeB/drop) 0-1 (A)</p> <p>- note: <i>Fill this element if the drop is the same for all the sizes of the model. Otherway specify it within the csRange element</i> (XPath KnitClothOrder/KCCObody/KCCOitem/phase/lotDetails/csRange/drop) 0-1 (A)</p>

	<p>- note: <i>used only if not already specified in the article code</i> (XPath KnitClothOrder/KCCObody/KCCOitem/apparelProd/ csRange/drop) 0-1 (A)</p> <p>- note: <i>used only if not already specified in the article code</i> (XPath KnitClothOrder/KCCObody/KCCOitem/apparelProd/ garmentCode/garmentCodeB/drop) 0-1 (A)</p> <p>- note: <i>Fill this element if the drop is the same for all the sizes of the model. Otherway specify it within the csRange element</i> (XPath KnitClothOrder/KCCObody/KCCOitem/endUseGroup/ csRange/sizeMatrix/sizeRow/drop) 0-1 (A)</p> <p>- note: <i>DEPRECATED, anyhow it is used only if not already specified in the article code or csRange</i> (XPath KnitClothOrder/KCCObody/KCCOitem/garTecSheet/ garConsumptionSet/garmentCode/garmentCodeB/drop) 0-1 (A)</p> <p>- note: <i>Fill this element if the drop is the same for all the sizes of the model. Otherway specify it within the csRange element</i> (XPath KnitClothOrder/KCCObody/KCCOitem/phase/lotDetails/ csRange/sizeMatrix/sizeRow/drop) 0-1 (A)</p> <p>- note: <i>DEPRECATED, anyhow it is used only if not already specified in the article code or csRange</i> (XPath KnitClothOrder/KCCObody/KCCOitem/apparelProd/ csRange/sizeMatrix/sizeRow/drop) 0-1 (A)</p> <p>- note: <i>DEPRECATED, anyhow it is used only if not already specified in the article code or csRange</i></p>
dyeN	<p>number of the dying batch of a textile product</p> <p>- base type: string, max length: 15, (XPath KnitClothOrder/KCCObody/KCCOitem/apparelComponent/ acsComponent/dyeN) 0-1 (XPath KnitClothOrder/KCCObody/KCCOitem/apparelProd/dyeN) 0-1 (XPath KnitClothOrder/KCCObody/KCCOitem/apparelComponent/ yarnComponent/dyeN) 0-1 (XPath KnitClothOrder/KCCObody/KCCOitem/garTecSheet/ garConsumptionSet/dyeN) 0-99 (XPath KnitClothOrder/KCCObody/KCCOitem/apparelComponent/ garmentPartComponent/dyeN) 0-1 (XPath KnitClothOrder/KCCObody/KCCOitem/phase/garConsumptionSet/dyeN) 0-99</p>
@email	<p>electronic mail address of the contact person within a Party</p> <p>- base type: string, max length: 250, (XPath KnitClothOrder/KCCObody/KCCOitem/thirdParty/person/@email) [Optional] (XPath KnitClothOrder/KCCOheader/buyer/person/@email) [Optional] (XPath KnitClothOrder/KCCOheader/subContractor/person/@email) [Optional] (XPath KnitClothOrder/KCCOheader/thirdParty/person/@email) [Optional] (XPath KnitClothOrder/KCCObody/KCCOitem/phase/thirdParty/ person/@email) [Optional]</p>
@encoding	<p>specifies the decoding algorithm of the binary object</p> <p>- base type: normalizedString, (XPath KnitClothOrder/KCCObody/KCCOitem/apparelComponent/ yarnComponent/refDoc/attachment/binaryObject/@encoding) [Optional] (Na) (XPath KnitClothOrder/KCCObody/KCCOitem/apparelComponent/ acsComponent/refDoc/attachment/binaryObject/@encoding) [Optional] (Na) (XPath KnitClothOrder/KCCObody/KCCOitem/phase/refDoc/ attachment/binaryObject/@encoding) [Optional] (Na) (XPath KnitClothOrder/KCCObody/KCCOitem/appMnfrOperation/ refDoc/attachment/binaryObject/@encoding) [Optional] (Na) (XPath KnitClothOrder/KCCObody/KCCOitem/apparelComponent/ fabricComponent/refDoc/attachment/binaryObject/@encoding) [Optional] (Na) ) (XPath KnitClothOrder/KCCObody/KCCOitem/garTecSheet/ refDoc/attachment/binaryObject/@encoding) [Optional] (Na)</p>

	<p>(XPath KnitClothOrder/KCCObody/KCCOitem/apparelComponent/garmentPartComponent/refDoc/attachment/binaryObject/@encoding) [Optional] (Na)</p> <p>(XPath KnitClothOrder/KCCOheader/refDoc/attachment/binaryObject/@encoding) [Optional] (N)</p>
encodingCode	<p>the encoding/decoding algorithm used with the external object (example is 'base64Binary')</p> <p>- base type: normalizedString,</p> <p>(XPath KnitClothOrder/KCCObody/KCCOitem/appMnfrOperation/refDoc/attachment/externalReference/encodingCode) 0-1 (N)</p> <p>(XPath KnitClothOrder/KCCOheader/refDoc/attachment/externalReference/encodingCode) 0-1 (N)</p> <p>(XPath KnitClothOrder/KCCObody/KCCOitem/apparelComponent/yarnComponent/refDoc/attachment/externalReference/encodingCode) 0-1 (N)</p> <p>(XPath KnitClothOrder/KCCObody/KCCOitem/phase/refDoc/attachment/externalReference/encodingCode) 0-1 (N)</p> <p>(XPath KnitClothOrder/KCCObody/KCCOitem/apparelComponent/acsComponent/refDoc/attachment/externalReference/encodingCode) 0-1 (N)</p> <p>(XPath KnitClothOrder/KCCObody/KCCOitem/garTecSheet/refDoc/attachment/externalReference/encodingCode) 0-1 (N)</p> <p>(XPath KnitClothOrder/KCCObody/KCCOitem/apparelComponent/garmentPartComponent/refDoc/attachment/externalReference/encodingCode) 0-1 (N)</p> <p>(XPath KnitClothOrder/KCCObody/KCCOitem/apparelComponent/fabricComponent/refDoc/attachment/externalReference/encodingCode) 0-1 (N)</p>
@endUse	<p>specifies the final use of the fabric</p> <p>- base type: string, cod. table: NT4</p> <p><a href="http://www.ebiz.enea.it/moda-ml/repository/codelist/v2018-1/gc_NT4.xml">http://www.ebiz.enea.it/moda-ml/repository/codelist/v2018-1/gc_NT4.xml</a></p> <p>(XPath KnitClothOrder/KCCObody/KCCOitem/garComInfo/@endUse) [Optional] (a)</p> <p>- nota: <i>When used for garments, use only PR: Production or SA: Sample codes.</i></p> <p>(XPath KnitClothOrder/garComInfo/@endUse) [Optional] (a)</p> <p>- nota: <i>When used for garments, use only PR: Production or SA: Sample codes.</i></p>
endUseGroupld	<p>group identifier.</p> <p>- base type: string,</p> <p>(XPath KnitClothOrder/KCCObody/KCCOitem/endUseGroup/endUseGroupld) 1-1 (N)</p>
EPC	<p>serial identifier used for tracing a physical item with RFID technology</p> <p>- base type: string,</p> <p>(XPath KnitClothOrder/KCCObody/KCCOitem/packages/EPCList/EPC) 1-unbounded</p> <p>(XPath KnitClothOrder/KCCObody/KCCOitem/phase/packages/EPCList/EPC) 1-unbounded</p>
fabric	<p>fabric number of the garment</p> <p>- base type: string, max length: 15,</p> <p>(XPath KnitClothOrder/KCCObody/KCCOitem/apparelProd/garmentCode/garmentCodeB/fabric) 0-1</p> <p>(XPath KnitClothOrder/KCCObody/KCCOitem/phase/garConsumptionSet/garmentCode/garmentCodeB/fabric) 0-1</p> <p>(XPath KnitClothOrder/KCCObody/KCCOitem/garTecSheet/garConsumptionSet/garmentPartCode/fabric) 0-1</p> <p>- note: <i>when a garment component, it should be the code assigned to the garment article</i></p> <p>(XPath KnitClothOrder/KCCObody/KCCOitem/apparelComponent/garmentPartComponent/garmentPartCode/fabric) 0-1</p> <p>- note: <i>when a garment component, it should be the code assigned to the garment article</i></p>

	<p>(XPath KnitClothOrder/KCCObody/KCCOitem/phase/garConsumptionSet/garmentPartCode/fabric) 0-1  - note: when a garment component, it should be the code assigned to the garment article</p> <p>(XPath KnitClothOrder/KCCObody/KCCOitem/apparelProd/garmentPartCode/fabric) 0-1  - note: when a garment component, it should be the code assigned to the garment article</p> <p>(XPath KnitClothOrder/KCCObody/KCCOitem/garTecSheet/garConsumptionSet/garmentCode/garmentCodeB/fabric) 0-1</p> <p>(XPath KnitClothOrder/KCCObody/KCCOitem/garTecSheet/garmentCode/garmentCodeB/fabric) 0-1</p>
@fax	<p>fax number of the contact person within a Party</p> <p>- base type: string, max length: 35,</p> <p>(XPath KnitClothOrder/KCCOheader/thirdParty/person/@fax) [Optional]</p> <p>(XPath KnitClothOrder/KCCObody/KCCOitem/thirdParty/person/@fax) [Optional]</p> <p>(XPath KnitClothOrder/KCCObody/KCCOitem/phase/thirdParty/person/@fax) [Optional]</p> <p>(XPath KnitClothOrder/KCCOheader/subContractor/person/@fax) [Optional]</p> <p>(XPath KnitClothOrder/KCCOheader/buyer/person/@fax) [Optional]</p>
@fibre	<p>type of fibre used in a textile product</p> <p>- base type: string, cod. table: T19</p> <p><a href="http://www.ebiz.enea.it/moda-ml/repository/codelist/v2018-1/gc_T19.xml">http://www.ebiz.enea.it/moda-ml/repository/codelist/v2018-1/gc_T19.xml</a></p> <p>(XPath KnitClothOrder/KCCObody/KCCOitem/garTecSheet/fabricCompos/percCompos/@fibre) [Required]</p>
fileName	<p>unique identifier (name) of the file</p> <p>- base type: string, max length: 255,</p> <p>(XPath KnitClothOrder/KCCObody/KCCOitem/phase/refDoc/attachment/fileName) 0-1 (N)</p> <p>(XPath KnitClothOrder/KCCObody/KCCOitem/appMnfrOperation/refDoc/attachment/fileName) 0-1 (N)</p> <p>(XPath KnitClothOrder/KCCObody/KCCOitem/apparelComponent/fabricComponent/refDoc/attachment/fileName) 0-1 (N)</p> <p>(XPath KnitClothOrder/KCCObody/KCCOitem/apparelComponent/acsComponent/refDoc/attachment/fileName) 0-1 (N)</p> <p>(XPath KnitClothOrder/KCCObody/KCCOitem/apparelComponent/yarnComponent/refDoc/attachment/fileName) 0-1 (N)</p> <p>(XPath KnitClothOrder/KCCObody/KCCOitem/garTecSheet/refDoc/attachment/fileName) 0-1 (N)</p> <p>(XPath KnitClothOrder/KCCOheader/refDoc/attachment/fileName) 0-1 (N)</p> <p>(XPath KnitClothOrder/KCCObody/KCCOitem/apparelComponent/garmentPartComponent/refDoc/attachment/fileName) 0-1 (N)</p>
fillingCriterion	<p>the assortment criterion to fill the specified kind of package: it states the homogeneity criterion (eg: "model", "color", "size").</p> <p>- base type: string, cod. table: NT51</p> <p><a href="http://www.ebiz.enea.it/moda-ml/repository/codelist/v2018-1/gc_NT51.xml">http://www.ebiz.enea.it/moda-ml/repository/codelist/v2018-1/gc_NT51.xml</a></p> <p>(XPath KnitClothOrder/KCCObody/KCCOitem/phase/packages/fillingCriterion) 0-9 (N)</p> <p>(XPath KnitClothOrder/KCCObody/KCCOitem/packages/fillingCriterion) 0-9 (N)</p>
finalIndicator	<p>final phase indicator.</p> <p>- base type: boolean,</p> <p>(XPath KnitClothOrder/KCCObody/KCCOitem/phase/finalIndicator) 0-1 (N)</p>
@finDiscount	<p>financial discount rate applied for payment by the date specified</p> <p>- base type: decimal, min inclusive: 0, max inclusive: 100, fraction digits: 2,</p> <p>(XPath KnitClothOrder/terms/payment/@finDiscount) [Optional]</p>
@finSurcharge	<p>financial surcharge rate applied for payment after the date specified</p> <p>- base type: decimal, min inclusive: 0, max inclusive: 100, fraction digits: 2,</p> <p>(XPath KnitClothOrder/terms/payment/@finSurcharge) [Optional]</p>

<b>@format</b>	<p>the format of the binary content (examples xml, pdf, doc,...)</p> <p>- base type: string,</p> <p>(XPath KnitClothOrder/KCCObody/KCCOitem/appMnfrOperation/refDoc/attachment/binaryObject/@format) [Optional] (Na)</p> <p>(XPath KnitClothOrder/KCCObody/KCCOitem/apparelComponent/acsComponent/refDoc/attachment/binaryObject/@format) [Optional] (Na)</p> <p>(XPath KnitClothOrder/KCCObody/KCCOitem/garTecSheet/refDoc/attachment/binaryObject/@format) [Optional] (Na)</p> <p>(XPath KnitClothOrder/KCCObody/KCCOitem/apparelComponent/garmentPartComponent/refDoc/attachment/binaryObject/@format) [Optional] (Na)</p> <p>(XPath KnitClothOrder/KCCObody/KCCOitem/apparelComponent/yarnComponent/refDoc/attachment/binaryObject/@format) [Optional] (Na)</p> <p>(XPath KnitClothOrder/KCCOheader/refDoc/attachment/binaryObject/@format) [Optional] (N)</p> <p>(XPath KnitClothOrder/KCCObody/KCCOitem/phase/refDoc/attachment/binaryObject/@format) [Optional] (Na)</p> <p>(XPath KnitClothOrder/KCCObody/KCCOitem/apparelComponent/fabricComponent/refDoc/attachment/binaryObject/@format) [Optional] (Na)</p>
<b>formatCode</b>	<p>the format of the external object (examples xml, pdf, doc,...)</p> <p>- base type: normalizedString,</p> <p>(XPath KnitClothOrder/KCCObody/KCCOitem/apparelComponent/yarnComponent/refDoc/attachment/externalReference/formatCode) 0-1 (N)</p> <p>(XPath KnitClothOrder/KCCObody/KCCOitem/garTecSheet/refDoc/attachment/externalReference/formatCode) 0-1 (N)</p> <p>(XPath KnitClothOrder/KCCObody/KCCOitem/apparelComponent/fabricComponent/refDoc/attachment/externalReference/formatCode) 0-1 (N)</p> <p>(XPath KnitClothOrder/KCCObody/KCCOitem/apparelComponent/garmentPartComponent/refDoc/attachment/externalReference/formatCode) 0-1 (N)</p> <p>(XPath KnitClothOrder/KCCObody/KCCOitem/phase/refDoc/attachment/externalReference/formatCode) 0-1 (N)</p> <p>(XPath KnitClothOrder/KCCObody/KCCOitem/apparelComponent/acsComponent/refDoc/attachment/externalReference/formatCode) 0-1 (N)</p> <p>(XPath KnitClothOrder/KCCOheader/refDoc/attachment/externalReference/formatCode) 0-1 (N)</p> <p>(XPath KnitClothOrder/KCCObody/KCCOitem/appMnfrOperation/refDoc/attachment/externalReference/formatCode) 0-1 (N)</p>
<b>garAttrib</b>	<p>garment's attribute to which the measures are referred</p> <p>- base type: string, cod. table: NT41</p> <p><a href="http://www.ebiz.enea.it/moda-ml/repository/codelist/v2018-1/gc_NT41.xml">http://www.ebiz.enea.it/moda-ml/repository/codelist/v2018-1/gc_NT41.xml</a></p> <p>(XPath KnitClothOrder/KCCObody/KCCOitem/garTecSheet/garMeaSet/garAttrib) 1-1</p>
<b>garPackCode</b>	<p>a code specifying the type of packaging used for the item.</p> <p>- base type: string,</p> <p>(XPath KnitClothOrder/KCCObody/KCCOitem/phase/packages/handlingChar/garPack/garPackCode) 1-1 (N)</p> <p>(XPath KnitClothOrder/garComInfo/garPack/garPackCode) 1-1 (N)</p> <p>(XPath KnitClothOrder/KCCObody/KCCOitem/packages/handlingChar/garPack/garPackCode) 1-1 (N)</p> <p>(XPath KnitClothOrder/KCCObody/KCCOitem/garComInfo/garPack/garPackCode) 1-1 (N)</p>
<b>garPackText</b>	<p>a free text specifying the type of packaging used for the item.</p> <p>- base type: string,</p> <p>(XPath KnitClothOrder/KCCObody/KCCOitem/packages/handlingChar/garPack/garPackText) 1-1 (N)</p> <p>(XPath KnitClothOrder/garComInfo/garPack/garPackText) 1-1 (N)</p> <p>(XPath KnitClothOrder/KCCObody/KCCOitem/garComInfo/garPack/garPackText) 1-1 (N)</p> <p>(XPath KnitClothOrder/KCCObody/KCCOitem/phase/packages/handlingChar/garPack/garPackText) 1-1 (N)</p>
<b>garSizeCode</b>	<p>code of a range of sizes</p> <p>- base type: string, max length: 15,</p>



	<p>(XPath  KnitClothOrder/KCCObody/KCCOitem/phase/garConsumptionSet/garConsumption/garSizeCode) 0-1 (A)</p> <p>(XPath KnitClothOrder/KCCObody/KCCOitem/garTecSheet/garSizeSet/garSizeTier/garSizeCode) 1-1 (A)</p> <p>(XPath KnitClothOrder/KCCObody/KCCOitem/garTecSheet/garConsumptionSet/garConsumption/garSizeCode) 0-1 (A)</p>
gPart	<p>code specifying the type of component or part of a fashion product (sleeve, neck, ...)</p> <p>- base type: string, cod. table: T48  <a href="http://www.ebiz.enea.it/moda-ml/repository/codelist/v2018-1/gc_T48.xml">http://www.ebiz.enea.it/moda-ml/repository/codelist/v2018-1/gc_T48.xml</a></p> <p>(XPath  KnitClothOrder/KCCObody/KCCOitem/phase/garConsumptionSet/garmentPartCode/gPart) 1-1</p> <p>(XPath KnitClothOrder/KCCObody/KCCOitem/apparelComponent/gPart) 0-1</p> <p>(XPath KnitClothOrder/KCCObody/KCCOitem/garTecSheet/garConsumptionSet/garmentPartCode/gPart) 1-1</p> <p>(XPath KnitClothOrder/KCCObody/KCCOitem/apparelComponent/garmentPartComponent/garmentPartCode/gPart) 1-1</p> <p>(XPath KnitClothOrder/KCCObody/KCCOitem/apparelProd/garmentPartCode/gPart) 1-1</p>
grossWeight	<p>the gross weight, declared for transport or customs purpose</p> <p>- base type: decimal, min inclusive: 0, fraction digits: 2,</p> <p>(XPath KnitClothOrder/KCCObody/KCCOitem/packages/handlingChar/grossWeight) 0-1</p> <p>(XPath KnitClothOrder/KCCObody/KCCOitem/phase/packages/handlingChar/grossWeight) 0-1</p> <p>(XPath KnitClothOrder/KCCObody/KCCOitem/garTecSheet/grossWeight) 0-1</p> <p>(XPath KnitClothOrder/terms/transInfo/grossWeight) 0-1</p>
handlingType	<p>information to handle the item (eg "breakable").</p> <p>- base type: string,</p> <p>(XPath KnitClothOrder/KCCObody/KCCOitem/packages/handlingChar/handlingType) 0-1 (N)</p> <p>(XPath KnitClothOrder/KCCObody/KCCOitem/phase/packages/handlingChar/handlingType) 0-1 (N)</p>
height	<p>effective height of a specified object</p> <p>- base type: decimal, min inclusive: 0, fraction digits: 2,</p> <p>(XPath KnitClothOrder/KCCObody/KCCOitem/packages/packageDim/height) 0-1</p> <p>(XPath KnitClothOrder/KCCObody/KCCOitem/phase/packages/packageDim/height) 0-1</p>
id	<p>primary identification code of a Party; it is recommended the format: nation code (ISO 3166) + VAT identification number (11 crt), with the qualifier "numberingOrg"= MF</p> <p>- base type: string, max length: 15,</p> <p>(XPath KnitClothOrder/KCCOheader/thirdParty/id) 1-1</p> <p>(XPath KnitClothOrder/KCCOheader/buyer/id) 1-1 (p)</p> <p>(XPath KnitClothOrder/KCCObody/KCCOitem/phase/thirdParty/id) 1-1</p> <p>(XPath KnitClothOrder/KCCOheader/subContractor/id) 1-1</p> <p>(XPath KnitClothOrder/KCCObody/KCCOitem/thirdParty/id) 1-1</p>
@idQualifier	<p>Qualification of the identifier.</p> <p>- base type: string,</p> <p>(XPath KnitClothOrder/KCCObody/KCCOitem/apparelComponent/fabricComponent/serialN/@idQualifier) [Optional] (N)</p> <p>- nota: <i>this attribute should be used when the numberingOrg attribute is not enough to declare the type of serial identifier</i></p> <p>(XPath KnitClothOrder/KCCObody/KCCOitem/apparelProdcRange/sizeMatrix/sizeRow/itemsList/itemIdentification/serialN/@idQualifier) [Optional] (N)</p> <p>- nota: <i>this attribute should be used when the numberingOrg attribute is not enough to declare the type of serial identifier</i></p>

	<p>(XPath KnitClothOrder/KCCObody/KCCOitem/phase/lotDetails/csRange/sizeMatrix/sizeRow/itemsList/itemIdentification/serialN/@idQualifier) [Optional] (N)</p> <p>- nota: <i>this attribute should be used when the numberingOrg attribute is not enough to declare the type of serial identifier</i></p> <p>(XPath KnitClothOrder/KCCObody/KCCOitem/endUseGroup/csRange/sizeMatrix/sizeRow/itemsList/itemIdentification/serialN/@idQualifier) [Optional] (N)</p> <p>- nota: <i>this attribute should be used when the numberingOrg attribute is not enough to declare the type of serial identifier</i></p> <p>(XPath KnitClothOrder/KCCObody/KCCOitem/progress/itemsList/itemIdentification/serialN/@idQualifier) [Optional] (N)</p> <p>- nota: <i>this attribute should be used when the numberingOrg attribute is not enough to declare the type of serial identifier</i></p> <p>(XPath KnitClothOrder/KCCOheader/buyer/additionalIdentifier/@idQualifier) [Optional] (Na)</p> <p>- nota: <i>this attribute should be used when the numberingOrg attribute is not enough to declare the type of identifier</i></p> <p>(XPath KnitClothOrder/KCCObody/KCCOitem/apparelComponent/fabricComponent/itemsList/itemIdentification/serialN/@idQualifier) [Optional] (N)</p> <p>- nota: <i>this attribute should be used when the numberingOrg attribute is not enough to declare the type of serial identifier</i></p>
image	<p>URL address of an annexed image</p> <p>- base type: string, max length: 255,</p> <p>(XPath KnitClothOrder/KCCObody/KCCOitem/garTecSheet/image) 0-99 (U)</p>
incoTerm	<p>specification of the terms of trade (INCOTERMS)</p> <p>- base type: string, cod. table: T3</p> <p><a href="http://www.ebiz.enea.it/moda-ml/repository/codelist/v2018-1/gc_T3.xml">http://www.ebiz.enea.it/moda-ml/repository/codelist/v2018-1/gc_T3.xml</a></p> <p>(XPath KnitClothOrder/terms/trade/incoTerm) 1-1</p>
incoTermText	<p>free text specifying the terms of trade (incoterm, location)</p> <p>- base type: string, max length: 250,</p> <p>(XPath KnitClothOrder/terms/trade/incoTermText) 1-1 (U)</p>
@isCharge	<p>Indicates if the element to which it refers is a charge (true = charge, false = allowance)</p> <p>- base type: boolean, min length: 0,</p> <p>(XPath KnitClothOrder/terms/allowanceCharge/@isCharge) [Optional] (N)</p>
@isURL	<p>it indicates if the referred element is an URL (true) or not (false)</p> <p>- base type: boolean,</p> <p>(XPath KnitClothOrder/KCCObody/KCCOitem/phase/refDoc/attachment/externalReference/uri/@isURL) [Optional] [Default= true] (Na)</p> <p>- nota: <i>usage of URLs is recommended</i></p> <p>(XPath KnitClothOrder/KCCObody/KCCOitem/apparelComponent/garmentPartComponent/refDoc/attachment/externalReference/uri/@isURL) [Optional] [Default= true] (Na)</p> <p>- nota: <i>usage of URLs is recommended</i></p> <p>(XPath KnitClothOrder/KCCObody/KCCOitem/appMnfrOperation/refDoc/attachment/externalReference/uri/@isURL) [Optional] [Default= true] (Na)</p> <p>- nota: <i>usage of URLs is recommended</i></p> <p>(XPath KnitClothOrder/KCCOheader/refDoc/attachment/externalReference/uri/@isURL) [Optional] [Default= true] (Na)</p> <p>- nota: <i>usage of URLs is recommended</i></p> <p>(XPath KnitClothOrder/KCCObody/KCCOitem/garTecSheet/refDoc/attachment/externalReference/uri/@isURL) [Optional] [Default= true] (Na)</p> <p>- nota: <i>usage of URLs is recommended</i></p> <p>(XPath KnitClothOrder/KCCObody/KCCOitem/apparelComponent/acsComponent/refDoc/attachment/externalReference/uri/@isURL) [Optional] [Default= true] (Na)</p>



	<p>- nota: <i>usage of URLs is recommended</i>  (XPath KnitClothOrder/KCCObody/KCCOitem/apparelComponent/fabricComponent/refDoc/attachment/externalReference/uri/@isURL) [Optional] [Default= true] (Na)</p> <p>- nota: <i>usage of URLs is recommended</i>  (XPath KnitClothOrder/KCCObody/KCCOitem/apparelComponent/yarnComponent/refDoc/attachment/externalReference/uri/@isURL) [Optional] [Default= true] (Na)</p> <p>- nota: <i>usage of URLs is recommended</i></p>
itemID	<p>number of the line/item of the referenced document</p> <p>- base type: string, max length: 40,  (XPath KnitClothOrder/KCCObody/KCCOitem/apparelComponent/yarnComponent/refDoc/itemID) 0-1 (U)  (XPath KnitClothOrder/KCCObody/KCCOitem/apparelComponent/garmentPartComponent/refDoc/itemID) 0-1 (U)  (XPath KnitClothOrder/KCCObody/KCCOitem/apparelComponent/fabricComponent/refDoc/itemID) 0-1 (U)  (XPath KnitClothOrder/KCCObody/KCCOitem/apparelComponent/acsComponent/refDoc/itemID) 0-1 (U)  (XPath KnitClothOrder/KCCObody/KCCOitem/garTecSheet/refDoc/itemID) 0-1 (U)  (XPath KnitClothOrder/KCCOheader/refDoc/itemID) 0-1 (U)  (XPath KnitClothOrder/KCCObody/KCCOitem/phase/refDoc/itemID) 0-1 (U)  (XPath KnitClothOrder/KCCObody/KCCOitem/appMnfrOperation/refDoc/itemID) 0-1 (U)</p>
itemsPerPackage	<p>the quantity of items that can be contained in a package.</p> <p>- base type: decimal,  (XPath KnitClothOrder/KCCObody/KCCOitem/phase/packages/itemsPerPackage) 0-1 (N)  (XPath KnitClothOrder/KCCObody/KCCOitem/packages/itemsPerPackage) 0-1 (N)</p>
jobName	<p>description of the elementary job</p> <p>- base type: string, max length: 40,  (XPath KnitClothOrder/KCCObody/KCCOitem/appMnfrOperation/jobName) 1-1</p>
@KCCOtype	<p>type of Order.</p> <p>- base type: string, cod. table: NT1  <a href="http://www.ebiz.enea.it/moda-ml/repository/codelist/v2018-1/gc_NT1.xml">http://www.ebiz.enea.it/moda-ml/repository/codelist/v2018-1/gc_NT1.xml</a>  (XPath KnitClothOrder/@KCCOtype) [Optional] (Na*)</p>
label	<p>indicates if the physical object specified has to be labelled</p> <p>- base type: boolean,  (XPath KnitClothOrder/KCCObody/KCCOitem/phase/packages/handlingChar/yarnPack/yarnReel/label) 0-1  (XPath KnitClothOrder/KCCObody/KCCOitem/phase/packages/handlingChar/yarnPack/yarnInWrap/label) 0-1  (XPath KnitClothOrder/KCCObody/KCCOitem/garComInfo/yarnPack/yarnInWrap/label) 0-1  (XPath KnitClothOrder/KCCObody/KCCOitem/packages/handlingChar/yarnPack/yarnReel/label) 0-1  (XPath KnitClothOrder/garComInfo/yarnPack/yarnInWrap/label) 0-1  (XPath KnitClothOrder/garComInfo/yarnPack/yarnReel/label) 0-1  (XPath KnitClothOrder/KCCObody/KCCOitem/garComInfo/yarnPack/yarnReel/label) 0-1  (XPath KnitClothOrder/KCCObody/KCCOitem/packages/handlingChar/yarnPack/yarnInWrap/label) 0-1</p>
labelWrit	<p>text that must be written on the lable of a specified physical object when its customization is required</p> <p>- base type: string, max length: 350,  (XPath KnitClothOrder/KCCObody/KCCOitem/packages/handlingChar/yarnPack/yarnInWrap/labelWrit) 0-1  (XPath KnitClothOrder/KCCObody/KCCOitem/packages/handlingChar/yarnPack/yarnReel/labelWrit) 0-1  (XPath KnitClothOrder/garComInfo/yarnPack/yarnInWrap/labelWrit) 0-1</p>

	<p>(XPath KnitClothOrder/KCCObody/KCCOitem/phase/packages/handlingChar/yarnPack/yarnInWrap/labelWrit) 0-1</p> <p>(XPath KnitClothOrder/garComInfo/yarnPack/yarnReel/labelWrit) 0-1</p> <p>(XPath KnitClothOrder/KCCObody/KCCOitem/garComInfo/yarnPack/yarnInWrap/labelWrit) 0-1</p> <p>(XPath KnitClothOrder/KCCObody/KCCOitem/garComInfo/yarnPack/yarnReel/labelWrit) 0-1</p> <p>(XPath KnitClothOrder/KCCObody/KCCOitem/phase/packages/handlingChar/yarnPack/yarnReel/labelWrit) 0-1</p>
legalName	<p>legal name of a Party</p> <p>- base type: string, max length: 250,</p> <p>(XPath KnitClothOrder/KCCObody/KCCOitem/thirdParty/legalName) 0-1 (U)</p> <p>(XPath KnitClothOrder/KCCOheader/buyer/legalName) 0-1 (U)</p> <p>(XPath KnitClothOrder/KCCObody/KCCOitem/phase/thirdParty/legalName) 0-1 (U)</p> <p>(XPath KnitClothOrder/KCCOheader/subContractor/legalName) 0-1 (U)</p> <p>(XPath KnitClothOrder/KCCOheader/thirdParty/legalName) 0-1 (U)</p>
legalRef	<p>legal reference of the duty or tax or fee category</p> <p>- base type: string,</p> <p>(XPath KnitClothOrder/terms/allowanceCharge/dtScheme/legalRef) 0-1 (A)</p> <p>(XPath KnitClothOrder/KCCObody/KCCOitem/dtScheme/legalRef) 0-1 (A)</p>
length	<p>effective length of a specified object</p> <p>- base type: decimal, min inclusive: 0, fraction digits: 2,</p> <p>(XPath KnitClothOrder/KCCObody/KCCOitem/phase/packages/packageDim/length) 1-1</p> <p>- note: <i>here the maximum dimension must also be specified</i></p> <p>(XPath KnitClothOrder/KCCObody/KCCOitem/packages/packageDim/length) 1-1</p> <p>- note: <i>here the maximum dimension must also be specified</i></p>
lineID	<p>unique identifier of the line item of the business document; it is set by the role that produces the document.</p> <p>- base type: string, max length: 30,</p> <p>(XPath KnitClothOrder/KCCObody/KCCOitem/lineID) 0-1 (N)</p>
lineN	<p>number of the line item of the present message (xml document); it is set by the role that produces the document. Usually it is a progressive number, but not always.</p> <p>- base type: positiveInteger, min inclusive: 1, max inclusive: 9999,</p> <p>(XPath KnitClothOrder/KCCObody/KCCOitem/lineN) 1-1</p>
@listName	<p>the name of the list of codes used to make an instance of the element (it might be thought as descriptive element, i.e. 'fabric printing technologies', or not, i.e. "T264")</p> <p>- base type: string, max length: 40,</p> <p>(XPath KnitClothOrder/KCCObody/KCCOitem/dtScheme/legalRef/@listName) [Optional] (a)</p> <p>- nota: <i>this attribute should always be used coupled with "numberingOrg"</i></p> <p>(XPath KnitClothOrder/KCCObody/KCCOitem/phase/lotDetails/csRange/garmentVariant/variantType/@listName) [Optional] (a)</p> <p>- nota: <i>this attribute should always be used coupled with "numberingOrg"</i></p> <p>(XPath KnitClothOrder/KCCObody/KCCOitem/phase/lotDetails/csRange/color/@listName) [Optional]</p> <p>- nota: <i>this attribute should always be used coupled with "numberingOrg"</i></p> <p>(XPath KnitClothOrder/KCCObody/KCCOitem/apparelComponent/garmentPartComponent/garmentPartCode/color/@listName) [Optional]</p> <p>- nota: <i>this attribute should always be used coupled with "numberingOrg"</i></p> <p>(XPath KnitClothOrder/KCCObody/KCCOitem/apparelComponent/garmentPartComponent/garmentPartCode/size/@listName) [Optional] (a)</p> <p>- nota: <i>this attribute should always be used coupled with "numberingOrg"</i></p> <p>(XPath KnitClothOrder/KCCObody/KCCOitem/apparelComponent/garmentPartComponent/garmentPartCode/fabric/@listName) [Optional]</p> <p>- nota: <i>this attribute should always be used coupled with "numberingOrg"</i></p>

(XPath KnitClothOrder/KCCObody/KCCOitem/apparelComponent/garmentPartComponent/garmentPartCode/mod/@listName) [Optional]

- nota: *this attribute should always be used coupled with “numberingOrg”*

(XPath KnitClothOrder/KCCObody/KCCOitem/appMnfrOperation/refDoc/season/@listName) [Optional] (a)

- nota: *this attribute should always be used coupled with “numberingOrg”*

(XPath KnitClothOrder/KCCObody/KCCOitem/apparelComponent/garmentPartComponent/refDoc/season/@listName) [Optional] (a)

- nota: *this attribute should always be used coupled with “numberingOrg”*

(XPath KnitClothOrder/KCCObody/KCCOitem/apparelComponent/fabricComponent/itemsList/qualityLevel/@listName) [Optional] (a)

- nota: *this attribute should always be used coupled with “numberingOrg”*

(XPath KnitClothOrder/KCCObody/KCCOitem/phase/phaseCode/@listName) [Optional] (a)

- nota: *this attribute should always be used coupled with “numberingOrg”*

(XPath KnitClothOrder/KCCObody/KCCOitem/apparelComponent/fabricComponent/refDoc/season/@listName) [Optional] (a)

- nota: *this attribute should always be used coupled with “numberingOrg”*

(XPath KnitClothOrder/KCCObody/KCCOitem/apparelComponent/acsComponent/acsCode/color/@listName) [Optional]

- nota: *this attribute should always be used coupled with “numberingOrg”*

(XPath KnitClothOrder/KCCObody/KCCOitem/phase/lotDetails/csRange/sizeMatrix/sizeRow/itemsList/qualityLevel/@listName) [Optional] (a)

- nota: *this attribute should always be used coupled with “numberingOrg”*

(XPath KnitClothOrder/KCCObody/KCCOitem/phase/lotDetails/csRange/sizeMatrix/sizeRow/size/@listName) [Optional] (a)

- nota: *this attribute should always be used coupled with “numberingOrg”*

(XPath KnitClothOrder/KCCObody/KCCOitem/apparelComponent/yarnComponent/refDoc/season/@listName) [Optional] (a)

- nota: *this attribute should always be used coupled with “numberingOrg”*

(XPath KnitClothOrder/KCCObody/KCCOitem/apparelComponent/acsComponent/refDoc/season/@listName) [Optional] (a)

- nota: *this attribute should always be used coupled with “numberingOrg”*

(XPath KnitClothOrder/KCCObody/KCCOitem/phase/refDoc/season/@listName) [Optional]

- nota: *this attribute should always be used coupled with “numberingOrg”*

(XPath KnitClothOrder/KCCObody/KCCOitem/progress/qualityLevel/@listName) [Optional]

- nota: *this attribute should always be used coupled with “numberingOrg”*

(XPath KnitClothOrder/KCCObody/KCCOitem/apparelComponent/yarnComponent/yarnCode/color/@listName) [Optional]

- nota: *this attribute should always be used coupled with “numberingOrg”*

(XPath KnitClothOrder/KCCObody/KCCOitem/apparelComponent/yarnComponent/yarnCode/art/@listName) [Optional]

- nota: *this attribute should always be used coupled with “numberingOrg”*

(XPath KnitClothOrder/KCCObody/KCCOitem/apparelComponent/acsComponent/acsCode/pattern/@listName) [Optional]

- nota: *this attribute should always be used coupled with “numberingOrg”*

(XPath KnitClothOrder/KCCObody/KCCOitem/apparelComponent/fabricComponent/texCode/pattern/@listName) [Optional]

- nota: *this attribute should always be used coupled with “numberingOrg”*

(XPath KnitClothOrder/KCCObody/KCCOitem/apparelComponent/fabricComponent/texCode/art/@listName) [Optional]

- nota: *this attribute should always be used coupled with “numberingOrg”*

(XPath KnitClothOrder/KCCObody/KCCOitem/phase/lotDetails/csRange/garmentVariant/variantCode/@listName) [Optional] (a)

- nota: *this attribute should always be used coupled with “numberingOrg”*

(XPath KnitClothOrder/KCCObody/KCCOitem/apparelComponent/fabricComponent/texCode/color/@listName) [Optional]

- nota: *this attribute should always be used coupled with “numberingOrg”*

(XPath KnitClothOrder/KCCObody/KCCOitem/phase/lotDetails/csRange/drop/@listName) [Optional] (a)

- nota: *this attribute should always be used coupled with “numberingOrg”*

(XPath KnitClothOrder/KCCObody/KCCOitem/apparelComponent/acsComponent/acsCode/art/@listName) [Optional]

- nota: *this attribute should always be used coupled with “numberingOrg”*

(XPath KnitClothOrder/KCCObody/KCCOitem/phase/lotDetails/csRange/sizeMatrix/sizeRow/drop/@listName) [Optional] (a)

- nota: *this attribute should always be used coupled with “numberingOrg”*

(XPath KnitClothOrder/KCCOheader/season/@listName) [Optional] (a)

- nota: *this attribute should always be used coupled with “numberingOrg”*

(XPath KnitClothOrder/KCCObody/KCCOitem/phase/lotDetails/csRange/sizeMatrix/sizeRow/additionalComponentCode/@listName) [Optional] (a)

- nota: *this attribute should always be used coupled with “numberingOrg”*

(XPath KnitClothOrder/KCCObody/KCCOitem/phase/garConsumptionSet/garmentPartCode/size/@listName) [Optional] (a)

- nota: *this attribute should always be used coupled with “numberingOrg”*

(XPath KnitClothOrder/KCCObody/KCCOitem/apparelProd/garmentPartCode/size/@listName) [Optional] (a)

- nota: *this attribute should always be used coupled with “numberingOrg”*

(XPath KnitClothOrder/KCCObody/KCCOitem/apparelProd/garmentCode/garmentCodeB/mod/@listName) [Optional]

- nota: *this attribute should always be used coupled with “numberingOrg”*

(XPath KnitClothOrder/KCCObody/KCCOitem/apparelProd/garmentPartCode/color/@listName) [Optional]

- nota: *this attribute should always be used coupled with “numberingOrg”*

(XPath KnitClothOrder/KCCObody/KCCOitem/phase/garConsumptionSet/garmentPartCode/color/@listName) [Optional]

- nota: *this attribute should always be used coupled with “numberingOrg”*

(XPath KnitClothOrder/KCCObody/KCCOitem/apparelProd/garmentPartCode/fabric/@listName) [Optional]

- nota: *this attribute should always be used coupled with “numberingOrg”*

(XPath KnitClothOrder/KCCOheader/refDoc/season/@listName) [Optional] (a)

- nota: *this attribute should always be used coupled with “numberingOrg”*

(XPath KnitClothOrder/KCCObody/KCCOitem/garTecSheet/refDoc/season/@listName) [Optional] (a)

- nota: *this attribute should always be used coupled with “numberingOrg”*

(XPath KnitClothOrder/KCCObody/KCCOitem/phase/garConsumptionSet/garmentCode/garmentCodeB/fabric/@listName) [Optional]

- nota: *this attribute should always be used coupled with “numberingOrg”*

(XPath KnitClothOrder/KCCObody/KCCOitem/garTecSheet/garmentCode/garmentCodeB/artGroup/@listName) [Optional]

- nota: *this attribute should always be used coupled with “numberingOrg”*

(XPath KnitClothOrder/KCCObody/KCCOitem/apparelProd/garmentCode/garmentCodeB/garmentVariant/variantType/@listName) [Optional] (a)

- nota: *this attribute should always be used coupled with “numberingOrg”*

(XPath KnitClothOrder/KCCObody/KCCOitem/apparelProd/garmentCode/garmentCodeB/color/@listName) [Optional]

- nota: *this attribute should always be used coupled with “numberingOrg”*

(XPath KnitClothOrder/KCCObody/KCCOitem/phase/garConsumptionSet/garmentCode/garmentCodeB/mod/@listName) [Optional]

- nota: *this attribute should always be used coupled with “numberingOrg”*

(XPath KnitClothOrder/KCCObody/KCCOitem/apparelProd/garmentCode/garmentCodeB/fabric/@listName) [Optional]

- nota: *this attribute should always be used coupled with “numberingOrg”*

(XPath KnitClothOrder/KCCObody/KCCOitem/garTecSheet/garmentCode/garmentCodeA/art/@listName) [Optional]

- nota: *this attribute should always be used coupled with “numberingOrg”*

(XPath KnitClothOrder/KCCObody/KCCOitem/phase/garConsumptionSet/garmentPartCode/fabric/@listName) [Optional]

- nota: *this attribute should always be used coupled with “numberingOrg”*

(XPath KnitClothOrder/KCCObody/KCCOitem/garTecSheet/garConsumptionSet/acsCode/pattern/@listName) [Optional]

- nota: *this attribute should always be used coupled with “numberingOrg”* (XPath KnitClothOrder/KCCObody/KCCOitem/phase/garConsumptionSet/yarnCode/color/@listName) [Optional]

- nota: *this attribute should always be used coupled with “numberingOrg”* (XPath KnitClothOrder/garComInfo/garPack/garPackCode/@listName) [Optional] (a)

- nota: *this attribute should always be used coupled with “numberingOrg”* (XPath KnitClothOrder/garComInfo/acsPack/acsPackCode/@listName) [Optional] (a)

- nota: *this attribute should always be used coupled with “numberingOrg”* (XPath KnitClothOrder/KCCObody/KCCOitem/phase/garConsumptionSet/yarnCode/art/@listName) [Optional]

- nota: *this attribute should always be used coupled with “numberingOrg”* (XPath KnitClothOrder/KCCObody/KCCOitem/garComInfo/operationalCode/@listName) [Optional]

- nota: *this attribute should always be used coupled with “numberingOrg”* (XPath KnitClothOrder/KCCObody/KCCOitem/garTecSheet/garConsumptionSet/acsCode/color/@listName) [Optional]

- nota: *this attribute should always be used coupled with “numberingOrg”* (XPath KnitClothOrder/KCCObody/KCCOitem/garTecSheet/garConsumptionSet/acsCode/art/@listName) [Optional]

- nota: *this attribute should always be used coupled with “numberingOrg”* (XPath KnitClothOrder/KCCObody/KCCOitem/garComInfo/season/@listName) [Optional] (a)

- nota: *this attribute should always be used coupled with “numberingOrg”* (XPath KnitClothOrder/KCCObody/KCCOitem/garTecSheet/garSizeSet/garSizeTier/garSizeCode/@listName) [Optional] (a)

- nota: *this attribute should always be used coupled with “numberingOrg”* (XPath KnitClothOrder/KCCObody/KCCOitem/apparelProd/garmentPartCode/mod/@listName) [Optional]

- nota: *this attribute should always be used coupled with “numberingOrg”* (XPath KnitClothOrder/KCCObody/KCCOitem/phase/garConsumptionSet/garmentPartCode/mod/@listName) [Optional]

- nota: *this attribute should always be used coupled with “numberingOrg”* (XPath KnitClothOrder/KCCObody/KCCOitem/garComInfo/productLine/@listName) [Optional]

- nota: *this attribute should always be used coupled with “numberingOrg”* (XPath KnitClothOrder/KCCObody/KCCOitem/garTecSheet/garMeaSet/garMea/size/@listName) [Optional] (a)

- nota: *this attribute should always be used coupled with “numberingOrg”* (XPath KnitClothOrder/KCCObody/KCCOitem/garComInfo/brand/@listName) [Optional] (a)

- nota: *this attribute should always be used coupled with “numberingOrg”* (XPath KnitClothOrder/KCCObody/KCCOitem/packages/handlingChar/garPack/garPackCode/@listName) [Optional] (a)

- nota: *this attribute should always be used coupled with “numberingOrg”* (XPath KnitClothOrder/KCCObody/KCCOitem/phase/garConsumptionSet/garmentCode/garmentCodeA/art/@listName) [Optional]

- nota: *this attribute should always be used coupled with “numberingOrg”* (XPath KnitClothOrder/KCCObody/KCCOitem/apparelProd/csRange/color/@listName) [Optional]

- nota: *this attribute should always be used coupled with “numberingOrg”* (XPath KnitClothOrder/KCCObody/KCCOitem/apparelProd/garmentCode/garmentCodeA/art/@listName) [Optional]

- nota: *this attribute should always be used coupled with “numberingOrg”* (XPath KnitClothOrder/KCCObody/KCCOitem/phase/packages/handlingChar/acsPack/acsPackCode/@listName) [Optional] (a)

- nota: *this attribute should always be used coupled with “numberingOrg”* (XPath KnitClothOrder/KCCObody/KCCOitem/phase/garConsumptionSet/garmentCode/garmentCodeB/size/@listName) [Optional] (a)



- nota: *this attribute should always be used coupled with “numberingOrg”*  
(XPath KnitClothOrder/KCCObody/KCCOitem/phase/garConsumptionSet/garmentCode/garmentCodeB/artGroup/@listName) [Optional]

- nota: *this attribute should always be used coupled with “numberingOrg”*  
(XPath KnitClothOrder/KCCObody/KCCOitem/apparelProd/csRange/sizeMatrix/sizeRow/itemsList/qualityLevel/@listName) [Optional] (a)

- nota: *this attribute should always be used coupled with “numberingOrg”*  
(XPath KnitClothOrder/KCCObody/KCCOitem/apparelProd/csRange/sizeMatrix/sizeRow/additionalComponentCode/@listName) [Optional] (a)

- nota: *this attribute should always be used coupled with “numberingOrg”*  
(XPath KnitClothOrder/KCCObody/KCCOitem/phase/garConsumptionSet/garConsumption/garSizeCode/@listName) [Optional] (a)

- nota: *this attribute should always be used coupled with “numberingOrg”*  
(XPath KnitClothOrder/KCCObody/KCCOitem/apparelProd/csRange/drop/@listName) [Optional] (a)

- nota: *this attribute should always be used coupled with “numberingOrg”*  
(XPath KnitClothOrder/KCCObody/KCCOitem/apparelProd/csRange/garmentVariant/variantCode/@listName) [Optional] (a)

- nota: *this attribute should always be used coupled with “numberingOrg”*  
(XPath KnitClothOrder/KCCObody/KCCOitem/apparelProd/csRange/garmentVariant/variantType/@listName) [Optional] (a)

- nota: *this attribute should always be used coupled with “numberingOrg”*  
(XPath KnitClothOrder/KCCObody/KCCOitem/apparelProd/csRange/sizeMatrix/sizeRow/size/@listName) [Optional] (a)

- nota: *this attribute should always be used coupled with “numberingOrg”*  
(XPath KnitClothOrder/KCCObody/KCCOitem/apparelProd/csRange/sizeMatrix/sizeRow/drop/@listName) [Optional] (a)

- nota: *this attribute should always be used coupled with “numberingOrg”*  
(XPath KnitClothOrder/KCCObody/KCCOitem/phase/garConsumptionSet/garmentCode/garmentCodeB/drop/@listName) [Optional] (a)

- nota: *this attribute should always be used coupled with “numberingOrg”*  
(XPath KnitClothOrder/KCCObody/KCCOitem/phase/garConsumptionSet/garmentCode/garmentCodeB/color/@listName) [Optional]

- nota: *this attribute should always be used coupled with “numberingOrg”*  
(XPath KnitClothOrder/KCCObody/KCCOitem/garTecSheet/garmentCode/garmentCodeB/garmentVariant/variantCode/@listName) [Optional] (a)

- nota: *this attribute should always be used coupled with “numberingOrg”*  
(XPath KnitClothOrder/KCCObody/KCCOitem/apparelProd/garmentCode/garmentCodeB/drop/@listName) [Optional] (a)

- nota: *this attribute should always be used coupled with “numberingOrg”*  
(XPath KnitClothOrder/KCCObody/KCCOitem/garTecSheet/garmentCode/garmentCodeB/drop/@listName) [Optional] (a)

- nota: *this attribute should always be used coupled with “numberingOrg”*  
(XPath KnitClothOrder/KCCObody/KCCOitem/phase/packages/handlingChar/garPack/garPackCode/@listName) [Optional] (a)

- nota: *this attribute should always be used coupled with “numberingOrg”*  
(XPath KnitClothOrder/KCCObody/KCCOitem/garTecSheet/garmentCode/garmentCodeB/size/@listName) [Optional] (a)

- nota: *this attribute should always be used coupled with “numberingOrg”*  
(XPath KnitClothOrder/KCCObody/KCCOitem/apparelProd/garmentCode/garmentCodeB/garmentVariant/variantCode/@listName) [Optional] (a)

- nota: *this attribute should always be used coupled with “numberingOrg”*  
(XPath KnitClothOrder/KCCObody/KCCOitem/garTecSheet/garmentCode/garmentCodeB/garmentVariant/variantType/@listName) [Optional] (a)

- nota: *this attribute should always be used coupled with “numberingOrg”*  
(XPath KnitClothOrder/KCCObody/KCCOitem/garTecSheet/garmentCode/garmentCodeB/mod/@listName) [Optional]

- nota: *this attribute should always be used coupled with “numberingOrg”*  
(XPath KnitClothOrder/KCCObody/KCCOitem/apparelProd/  
garmentCode/garmentCodeB/artGroup/@listName) [Optional]

- nota: *this attribute should always be used coupled with “numberingOrg”*  
(XPath  
KnitClothOrder/KCCObody/KCCOitem/phase/garConsumptionSet/garmentC  
ode/garmentCodeB/garmentVariant/variantCode/@listName) [Optional] (a)

- nota: *this attribute should always be used coupled with “numberingOrg”*  
(XPath KnitClothOrder/KCCObody/KCCOitem/garTecSheet/  
garmentCode/garmentCodeB/fabric/@listName) [Optional]

- nota: *this attribute should always be used coupled with “numberingOrg”*  
(XPath  
KnitClothOrder/KCCObody/KCCOitem/phase/garConsumptionSet/garmentC  
ode/garmentCodeB/garmentVariant/variantType/@listName) [Optional] (a)

- nota: *this attribute should always be used coupled with “numberingOrg”*  
(XPath KnitClothOrder/KCCObody/KCCOitem/garTecSheet/  
garmentCode/garmentCodeB/color/@listName) [Optional]

- nota: *this attribute should always be used coupled with “numberingOrg”*  
(XPath KnitClothOrder/KCCObody/KCCOitem/apparelProd/  
garmentCode/garmentCodeB/size/@listName) [Optional] (a)

- nota: *this attribute should always be used coupled with “numberingOrg”*  
(XPath KnitClothOrder/KCCObody/KCCOitem/garTecSheet/  
garConsumptionSet/texCode/art/@listName) [Optional]

- nota: *this attribute should always be used coupled with “numberingOrg”*  
(XPath  
KnitClothOrder/KCCObody/KCCOitem/phase/garConsumptionSet/acsCode/c  
olor/@listName) [Optional]

- nota: *this attribute should always be used coupled with “numberingOrg”*  
(XPath KnitClothOrder/KCCObody/KCCOitem/endUseGroup/  
csRange/garmentVariant/variantType/@listName) [Optional] (a)

- nota: *this attribute should always be used coupled with “numberingOrg”*  
(XPath KnitClothOrder/KCCObody/KCCOitem/garTecSheet/  
garConsumptionSet/garmentCode/garmentCodeB/mod/@listName) [Optiona  
l]

- nota: *this attribute should always be used coupled with “numberingOrg”*  
(XPath KnitClothOrder/KCCObody/KCCOitem/garTecSheet/  
garConsumptionSet/garmentCode/garmentCodeB/fabric/@listName) [Option  
al]

- nota: *this attribute should always be used coupled with “numberingOrg”*  
(XPath KnitClothOrder/KCCObody/KCCOitem/garTecSheet/  
garConsumptionSet/garmentCode/garmentCodeB/garmentVariant/variantTy  
pe/@listName) [Optional] (a)

- nota: *this attribute should always be used coupled with “numberingOrg”*  
(XPath KnitClothOrder/KCCObody/KCCOitem/endUseGroup/  
csRange/garmentVariant/variantCode/@listName) [Optional] (a)

- nota: *this attribute should always be used coupled with “numberingOrg”*  
(XPath KnitClothOrder/KCCObody/KCCOitem/garTecSheet/  
garConsumptionSet/garmentCode/garmentCodeB/color/@listName) [Option  
al]

- nota: *this attribute should always be used coupled with “numberingOrg”*  
(XPath KnitClothOrder/KCCObody/KCCOitem/garTecSheet/  
garConsumptionSet/garmentPartCode/color/@listName) [Optional]

- nota: *this attribute should always be used coupled with “numberingOrg”*  
(XPath  
KnitClothOrder/KCCObody/KCCOitem/phase/garConsumptionSet/texCode/a  
rt/@listName) [Optional]

- nota: *this attribute should always be used coupled with “numberingOrg”*  
(XPath KnitClothOrder/KCCObody/KCCOitem/garTecSheet/  
garConsumptionSet/garmentPartCode/fabric/@listName) [Optional]

- nota: *this attribute should always be used coupled with “numberingOrg”*  
(XPath KnitClothOrder/terms/allowanceCharge/dtScheme/  
legalRef/@listName) [Optional]

- nota: *this attribute should always be used coupled with “numberingOrg”*  
(XPath KnitClothOrder/KCCObody/KCCOitem/endUseGroup/  
csRange/color/@listName) [Optional]

- nota: *this attribute should always be used coupled with “numberingOrg”*

(XPath KnitClothOrder/KCCObody/KCCOitem/packages/handlingChar/acsPack/acsPackCode/@listName) [Optional] (a)

- nota: *this attribute should always be used coupled with “numberingOrg”*

(XPath KnitClothOrder/KCCObody/KCCOitem/garTecSheet/garConsumptionSet/garmentPartCode/size/@listName) [Optional] (a)

- nota: *this attribute should always be used coupled with “numberingOrg”*

(XPath KnitClothOrder/KCCObody/KCCOitem/endUseGroup/csRange/sizeMatrix/sizeRow/size/@listName) [Optional] (a)

- nota: *this attribute should always be used coupled with “numberingOrg”*

(XPath KnitClothOrder/KCCObody/KCCOitem/garTecSheet/garConsumptionSet/garmentCode/garmentCodeB/artGroup/@listName) [Optional]

- nota: *this attribute should always be used coupled with “numberingOrg”*

(XPath KnitClothOrder/KCCObody/KCCOitem/endUseGroup/csRange/sizeMatrix/sizeRow/drop/@listName) [Optional] (a)

- nota: *this attribute should always be used coupled with “numberingOrg”*

(XPath KnitClothOrder/KCCObody/KCCOitem/garTecSheet/garConsumptionSet/garmentCode/garmentCodeA/art/@listName) [Optional]

- nota: *this attribute should always be used coupled with “numberingOrg”*

(XPath KnitClothOrder/KCCObody/KCCOitem/progress/itemsList/qualityLevel/@listName) [Optional] (a)

- nota: *this attribute should always be used coupled with “numberingOrg”*

(XPath KnitClothOrder/KCCObody/KCCOitem/endUseGroup/csRange/sizeMatrix/sizeRow/itemsList/qualityLevel/@listName) [Optional] (a)

)

- nota: *this attribute should always be used coupled with “numberingOrg”*

(XPath KnitClothOrder/KCCObody/KCCOitem/garTecSheet/garConsumptionSet/garConsumption/garSizeCode/@listName) [Optional] (a)

- nota: *this attribute should always be used coupled with “numberingOrg”*

(XPath KnitClothOrder/KCCObody/KCCOitem/garTecSheet/garConsumptionSet/garmentCode/garmentCodeB/garmentVariant/variantCode/@listName) [Optional] (a)

- nota: *this attribute should always be used coupled with “numberingOrg”*

(XPath KnitClothOrder/KCCObody/KCCOitem/phase/garConsumptionSet/acsCode/pattern/@listName) [Optional]

- nota: *this attribute should always be used coupled with “numberingOrg”*

(XPath KnitClothOrder/KCCObody/KCCOitem/endUseGroup/csRange/drop/@listName) [Optional] (a)

- nota: *this attribute should always be used coupled with “numberingOrg”*

(XPath KnitClothOrder/KCCObody/KCCOitem/endUseGroup/csRange/sizeMatrix/sizeRow/additionalComponentCode/@listName) [Optional] (a)

- nota: *this attribute should always be used coupled with “numberingOrg”*

(XPath KnitClothOrder/KCCObody/KCCOitem/garTecSheet/garConsumptionSet/garmentCode/garmentCodeB/size/@listName) [Optional] (a)

] (a)

- nota: *this attribute should always be used coupled with “numberingOrg”*

(XPath KnitClothOrder/KCCObody/KCCOitem/phase/garConsumptionSet/acsCode/art/@listName) [Optional]

- nota: *this attribute should always be used coupled with “numberingOrg”*

(XPath KnitClothOrder/KCCObody/KCCOitem/garTecSheet/garConsumptionSet/garmentCode/garmentCodeB/drop/@listName) [Optional] (a)

] (a)

- nota: *this attribute should always be used coupled with “numberingOrg”*

(XPath KnitClothOrder/KCCObody/KCCOitem/phase/garConsumptionSet/texCode/pattern/@listName) [Optional]

- nota: *this attribute should always be used coupled with “numberingOrg”*

(XPath KnitClothOrder/garComInfo/season/@listName) [Optional] (a)

- nota: *this attribute should always be used coupled with “numberingOrg”*

(XPath KnitClothOrder/KCCObody/KCCOitem/garTecSheet/garConsumptionSet/texCode/pattern/@listName) [Optional]

- nota: *this attribute should always be used coupled with “numberingOrg”*

(XPath KnitClothOrder/garComInfo/operationalCode/@listName) [Optional] (a)



	<ul style="list-style-type: none"> <li>- nota: <i>this attribute should always be used coupled with “numberingOrg”</i> (XPath KnitClothOrder/garComInfo/brand/@listName) [Optional] (a)</li> <li>- nota: <i>this attribute should always be used coupled with “numberingOrg”</i> (XPath KnitClothOrder/KCCObody/KCCOitem/phase/garConsumptionSet/texCode/color/@listName) [Optional]</li> <li>- nota: <i>this attribute should always be used coupled with “numberingOrg”</i> (XPath KnitClothOrder/KCCObody/KCCOitem/garTecSheet/garConsumptionSet/yarnCode/color/@listName) [Optional]</li> <li>- nota: <i>this attribute should always be used coupled with “numberingOrg”</i> (XPath KnitClothOrder/KCCObody/KCCOitem/garTecSheet/garConsumptionSet/texCode/color/@listName) [Optional]</li> <li>- nota: <i>this attribute should always be used coupled with “numberingOrg”</i> (XPath KnitClothOrder/KCCObody/KCCOitem/garComInfo/garPack/garPackCode/@listName) [Optional] (a)</li> <li>- nota: <i>this attribute should always be used coupled with “numberingOrg”</i> (XPath KnitClothOrder/KCCObody/KCCOitem/garTecSheet/garConsumptionSet/yarnCode/art/@listName) [Optional]</li> <li>- nota: <i>this attribute should always be used coupled with “numberingOrg”</i> (XPath KnitClothOrder/KCCObody/KCCOitem/garComInfo/acsPack/acsPackCode/@listName) [Optional] (a)</li> <li>- nota: <i>this attribute should always be used coupled with “numberingOrg”</i> (XPath KnitClothOrder/garComInfo/productLine/@listName) [Optional] (a)</li> <li>- nota: <i>this attribute should always be used coupled with “numberingOrg”</i> (XPath KnitClothOrder/KCCObody/KCCOitem/garTecSheet/garConsumptionSet/garmentPartCode/mod/@listName) [Optional]</li> <li>- nota: <i>this attribute should always be used coupled with “numberingOrg”</i></li> </ul>
<p>@listVersion</p>	<p>it specifie the version of the list of codes used to make an instance of the element</p> <ul style="list-style-type: none"> <li>- base type: string, max length: 6, (XPath KnitClothOrder/KCCObody/KCCOitem/endUseGroup/csRange/sizeMatrix/sizeRow/additionalComponentCode/@listVersion) [Optional] (a)</li> <li>- nota: <i>this attribute should always be used coupled with “numberingOrg” and “listName”</i> (XPath KnitClothOrder/KCCObody/KCCOitem/phase/packages/handlingChar/acsPack/acsPackCode/@listVersion) [Optional] (a)</li> <li>- nota: <i>this attribute should always be used coupled with “numberingOrg” and “listName”</i> (XPath KnitClothOrder/KCCObody/KCCOitem/dtScheme/legalRef/@listVersion) [Optional] (a)</li> <li>- nota: <i>this attribute should always be used coupled with “numberingOrg” and “listName”</i> (XPath KnitClothOrder/KCCObody/KCCOitem/apparelComponent/garmentPartComponent/garmentPartCode/color/@listVersion) [Optional]</li> <li>- nota: <i>this attribute should always be used coupled with “numberingOrg” and “listName”</i> (XPath KnitClothOrder/KCCObody/KCCOitem/endUseGroup/csRange/drop/@listVersion) [Optional] (a)</li> <li>- nota: <i>this attribute should always be used coupled with “numberingOrg” and “listName”</i> (XPath KnitClothOrder/KCCObody/KCCOitem/apparelProd/garmentCode/garmentCodeB/artGroup/@listVersion) [Optional]</li> <li>- nota: <i>this attribute should always be used coupled with “numberingOrg” and “listName”</i> (XPath KnitClothOrder/KCCObody/KCCOitem/apparelComponent/acsComponent/refDoc/season/@listVersion) [Optional] (a)</li> <li>- nota: <i>this attribute should always be used coupled with “numberingOrg” and “listName”</i> (XPath KnitClothOrder/garComInfo/garPack/garPackCode/@listVersion) [Optional] (a)</li> <li>- nota: <i>this attribute should always be used coupled with “numberingOrg” and “listName”</i></li> </ul>

(XPath KnitClothOrder/KCCObody/KCCOitem/garComInfo/productLine/@listVersion) [Optional]

- nota: *this attribute should always be used coupled with “numberingOrg” and “listName”*

(XPath KnitClothOrder/garComInfo/operationalCode/@listVersion) [Optional] (a)

- nota: *this attribute should always be used coupled with “numberingOrg” and “listName”*

(XPath KnitClothOrder/KCCObody/KCCOitem/endUseGroup/csRange/sizeMatrix/sizeRow/size/@listVersion) [Optional] (a)

- nota: *this attribute should always be used coupled with “numberingOrg” and “listName”*

(XPath KnitClothOrder/KCCObody/KCCOitem/apparelProd/csRange/garmentVariant/variantType/@listVersion) [Optional] (a)

- nota: *this attribute should always be used coupled with “numberingOrg” and “listName”*

(XPath KnitClothOrder/KCCObody/KCCOitem/garComInfo/operationalCode/@listVersion) [Optional]

- nota: *this attribute should always be used coupled with “numberingOrg” and “listName”*

(XPath KnitClothOrder/KCCObody/KCCOitem/apparelProd/csRange/garmentVariant/variantCode/@listVersion) [Optional] (a)

- nota: *this attribute should always be used coupled with “numberingOrg” and “listName”*

(XPath KnitClothOrder/KCCObody/KCCOitem/endUseGroup/csRange/sizeMatrix/sizeRow/itemsList/qualityLevel/@listVersion) [Optional] (a)

- nota: *this attribute should always be used coupled with “numberingOrg” and “listName”*

(XPath KnitClothOrder/KCCObody/KCCOitem/apparelComponent/garmentPartComponent/garmentPartCode/mod/@listVersion) [Optional]

- nota: *this attribute should always be used coupled with “numberingOrg” and “listName”*

(XPath KnitClothOrder/garComInfo/acsPack/acsPackCode/@listVersion) [Optional] (a)

- nota: *this attribute should always be used coupled with “numberingOrg” and “listName”*

(XPath KnitClothOrder/garComInfo/productLine/@listVersion) [Optional] (a)

- nota: *this attribute should always be used coupled with “numberingOrg” and “listName”*

(XPath KnitClothOrder/KCCObody/KCCOitem/apparelProd/garmentCode/garmentCodeA/art/@listVersion) [Optional]

- nota: *this attribute should always be used coupled with “numberingOrg” and “listName”*

(XPath KnitClothOrder/KCCObody/KCCOitem/endUseGroup/csRange/sizeMatrix/sizeRow/drop/@listVersion) [Optional] (a)

- nota: *this attribute should always be used coupled with “numberingOrg” and “listName”*

(XPath KnitClothOrder/KCCObody/KCCOitem/apparelComponent/garmentPartComponent/garmentPartCode/fabric/@listVersion) [Optional]

- nota: *this attribute should always be used coupled with “numberingOrg” and “listName”*

(XPath KnitClothOrder/KCCObody/KCCOitem/garComInfo/acsPack/acsPackCode/@listVersion) [Optional] (a)

- nota: *this attribute should always be used coupled with “numberingOrg” and “listName”*

(XPath KnitClothOrder/KCCObody/KCCOitem/apparelProd/csRange/color/@listVersion) [Optional]

- nota: *this attribute should always be used coupled with “numberingOrg” and “listName”*

(XPath KnitClothOrder/KCCObody/KCCOitem/apparelProd/garmentCode/garmentCodeB/fabric/@listVersion) [Optional]

- nota: *this attribute should always be used coupled with “numberingOrg” and “listName”*

	<p>(XPath KnitClothOrder/KCCObody/KCCOitem/apparelProd/garmentPartCode/fabric/@listVersion) [Optional]</p> <p>- nota: <i>this attribute should always be used coupled with “numberingOrg” and “listName”</i></p> <p>(XPath KnitClothOrder/KCCObody/KCCOitem/apparelProd/garmentCode/garmentCodeB/mod/@listVersion) [Optional]</p> <p>- nota: <i>this attribute should always be used coupled with “numberingOrg” and “listName”</i></p> <p>(XPath KnitClothOrder/KCCObody/KCCOitem/apparelProd/garmentPartCode/mod/@listVersion) [Optional]</p> <p>- nota: <i>this attribute should always be used coupled with “numberingOrg” and “listName”</i></p> <p>(XPath KnitClothOrder/KCCObody/KCCOitem/apparelComponent/acsComponent/acsCode/pattern/@listVersion) [Optional]</p> <p>- nota: <i>this attribute should always be used coupled with “numberingOrg” and “listName”</i></p> <p>(XPath KnitClothOrder/KCCObody/KCCOitem/phase/packages/handlingChar/garPack/garPackCode/@listVersion) [Optional] (a)</p> <p>- nota: <i>this attribute should always be used coupled with “numberingOrg” and “listName”</i></p> <p>(XPath KnitClothOrder/KCCObody/KCCOitem/apparelProd/garmentCode/garmentCodeB/color/@listVersion) [Optional]</p> <p>- nota: <i>this attribute should always be used coupled with “numberingOrg” and “listName”</i></p> <p>(XPath KnitClothOrder/KCCObody/KCCOitem/apparelProd/garmentPartCode/color/@listVersion) [Optional]</p> <p>- nota: <i>this attribute should always be used coupled with “numberingOrg” and “listName”</i></p> <p>(XPath KnitClothOrder/KCCObody/KCCOitem/apparelComponent/garmentPartComponent/refDoc/season/@listVersion) [Optional] (a)</p> <p>- nota: <i>this attribute should always be used coupled with “numberingOrg” and “listName”</i></p> <p>(XPath KnitClothOrder/KCCObody/KCCOitem/apparelComponent/acsComponent/acsCode/art/@listVersion) [Optional]</p> <p>- nota: <i>this attribute should always be used coupled with “numberingOrg” and “listName”</i></p> <p>(XPath KnitClothOrder/KCCObody/KCCOitem/garComInfo/garPack/garPackCode/@listVersion) [Optional] (a)</p> <p>- nota: <i>this attribute should always be used coupled with “numberingOrg” and “listName”</i></p> <p>(XPath KnitClothOrder/terms/allowanceCharge/dtScheme/legalRef/@listVersion) [Optional]</p> <p>- nota: <i>this attribute should always be used coupled with “numberingOrg” and “listName”</i></p> <p>(XPath KnitClothOrder/KCCObody/KCCOitem/packages/handlingChar/acsPack/acsPackCode/@listVersion) [Optional] (a)</p> <p>- nota: <i>this attribute should always be used coupled with “numberingOrg” and “listName”</i></p> <p>(XPath KnitClothOrder/KCCObody/KCCOitem/apparelProd/garmentPartCode/size/@listVersion) [Optional] (a)</p> <p>- nota: <i>this attribute should always be used coupled with “numberingOrg” and “listName”</i></p> <p>(XPath KnitClothOrder/KCCObody/KCCOitem/apparelComponent/garmentPartComponent/garmentPartCode/size/@listVersion) [Optional] (a)</p> <p>- nota: <i>this attribute should always be used coupled with “numberingOrg” and “listName”</i></p> <p>(XPath KnitClothOrder/garComInfo/brand/@listVersion) [Optional] (a)</p> <p>- nota: <i>this attribute should always be used coupled with “numberingOrg” and “listName”</i></p> <p>(XPath KnitClothOrder/KCCObody/KCCOitem/apparelComponent/acsComponent/acsCode/color/@listVersion) [Optional]</p> <p>- nota: <i>this attribute should always be used coupled with “numberingOrg” and “listName”</i></p>
--	--

(XPath KnitClothOrder/KCCObody/KCCOitem/endUseGroup/csRange/garmentVariant/variantCode/@listVersion) [Optional] (a)  
- nota: *this attribute should always be used coupled with “numberingOrg” and “listName”*

(XPath KnitClothOrder/KCCObody/KCCOitem/garComInfo/brand/@listVersion) [Optional] (a)  
- nota: *this attribute should always be used coupled with “numberingOrg” and “listName”*

(XPath KnitClothOrder/KCCObody/KCCOitem/apparelProd/garmentCode/garmentCodeB/size/@listVersion) [Optional] (a)  
- nota: *this attribute should always be used coupled with “numberingOrg” and “listName”*

(XPath KnitClothOrder/KCCObody/KCCOitem/apparelProd/garmentCode/garmentCodeB/drop/@listVersion) [Optional] (a)  
- nota: *this attribute should always be used coupled with “numberingOrg” and “listName”*

(XPath KnitClothOrder/KCCObody/KCCOitem/endUseGroup/csRange/color/@listVersion) [Optional]  
- nota: *this attribute should always be used coupled with “numberingOrg” and “listName”*

(XPath KnitClothOrder/KCCObody/KCCOitem/apparelProd/garmentCode/garmentCodeB/garmentVariant/variantType/@listVersion) [Optional] (a)  
- nota: *this attribute should always be used coupled with “numberingOrg” and “listName”*

(XPath KnitClothOrder/garComInfo/season/@listVersion) [Optional] (a)  
- nota: *this attribute should always be used coupled with “numberingOrg” and “listName”*

(XPath KnitClothOrder/KCCObody/KCCOitem/garComInfo/season/@listVersion) [Optional] (a)  
- nota: *this attribute should always be used coupled with “numberingOrg” and “listName”*

(XPath KnitClothOrder/KCCObody/KCCOitem/apparelProd/garmentCode/garmentCodeB/garmentVariant/variantCode/@listVersion) [Optional] (a)  
- nota: *this attribute should always be used coupled with “numberingOrg” and “listName”*

(XPath KnitClothOrder/KCCObody/KCCOitem/endUseGroup/csRange/garmentVariant/variantType/@listVersion) [Optional] (a)  
- nota: *this attribute should always be used coupled with “numberingOrg” and “listName”*

(XPath KnitClothOrder/KCCObody/KCCOitem/appMnfrOperation/refDoc/season/@listVersion) [Optional] (a)  
- nota: *this attribute should always be used coupled with “numberingOrg” and “listName”*

(XPath KnitClothOrder/KCCObody/KCCOitem/phase/garConsumptionSet/texCode/color/@listVersion) [Optional]  
- nota: *this attribute should always be used coupled with “numberingOrg” and “listName”*

(XPath KnitClothOrder/KCCObody/KCCOitem/garTecSheet/garConsumptionSet/yarnCode/art/@listVersion) [Optional]  
- nota: *this attribute should always be used coupled with “numberingOrg” and “listName”*

(XPath KnitClothOrder/KCCObody/KCCOitem/garTecSheet/garConsumptionSet/texCode/color/@listVersion) [Optional]  
- nota: *this attribute should always be used coupled with “numberingOrg” and “listName”*

(XPath KnitClothOrder/KCCObody/KCCOitem/phase/lotDetails/csRange/sizeMatrix/sizeRow/drop/@listVersion) [Optional] (a)  
- nota: *this attribute should always be used coupled with “numberingOrg” and “listName”*

(XPath KnitClothOrder/KCCObody/KCCOitem/garTecSheet/garConsumptionSet/texCode/pattern/@listVersion) [Optional]

- nota: *this attribute should always be used coupled with “numberingOrg” and “listName”*  
(XPath KnitClothOrder/KCCObody/KCCOitem/apparelComponent/yarnComponent/refDoc/season/@listVersion) [Optional] (a)

- nota: *this attribute should always be used coupled with “numberingOrg” and “listName”*  
(XPath KnitClothOrder/KCCObody/KCCOitem/garTecSheet/garConsumptionSet/garmentPartCode/mod/@listVersion) [Optional]

- nota: *this attribute should always be used coupled with “numberingOrg” and “listName”*  
(XPath KnitClothOrder/KCCObody/KCCOitem/phase/garConsumptionSet/texCode/art/@listVersion) [Optional]

- nota: *this attribute should always be used coupled with “numberingOrg” and “listName”*  
(XPath KnitClothOrder/KCCObody/KCCOitem/phase/garConsumptionSet/texCode/pattern/@listVersion) [Optional]

- nota: *this attribute should always be used coupled with “numberingOrg” and “listName”*  
(XPath KnitClothOrder/KCCObody/KCCOitem/phase/lotDetails/csRange/sizeMatrix/sizeRow/size/@listVersion) [Optional] (a)

- nota: *this attribute should always be used coupled with “numberingOrg” and “listName”*  
(XPath KnitClothOrder/KCCObody/KCCOitem/garTecSheet/garConsumptionSet/yarnCode/color/@listVersion) [Optional]

- nota: *this attribute should always be used coupled with “numberingOrg” and “listName”*  
(XPath KnitClothOrder/KCCObody/KCCOitem/garTecSheet/garConsumptionSet/acsCode/art/@listVersion) [Optional]

- nota: *this attribute should always be used coupled with “numberingOrg” and “listName”*  
(XPath KnitClothOrder/KCCObody/KCCOitem/phase/garConsumptionSet/yarnCode/color/@listVersion) [Optional]

- nota: *this attribute should always be used coupled with “numberingOrg” and “listName”*  
(XPath KnitClothOrder/KCCObody/KCCOitem/garTecSheet/garMeaSet/garMea/size/@listVersion) [Optional] (a)

- nota: *this attribute should always be used coupled with “numberingOrg” and “listName”*  
(XPath KnitClothOrder/KCCObody/KCCOitem/phase/garConsumptionSet/garmentPartCode/mod/@listVersion) [Optional]

- nota: *this attribute should always be used coupled with “numberingOrg” and “listName”*  
(XPath KnitClothOrder/KCCObody/KCCOitem/phase/lotDetails/csRange/drop/@listVersion) [Optional] (a)

- nota: *this attribute should always be used coupled with “numberingOrg” and “listName”*  
(XPath KnitClothOrder/KCCObody/KCCOitem/phase/lotDetails/csRange/sizeMatrix/sizeRow/additionalComponentCode/@listVersion) [Optional] (a)

- nota: *this attribute should always be used coupled with “numberingOrg” and “listName”*  
(XPath KnitClothOrder/KCCOheader/season/@listVersion) [Optional] (a)

- nota: *this attribute should always be used coupled with “numberingOrg” and “listName”*  
(XPath KnitClothOrder/KCCObody/KCCOitem/garTecSheet/garConsumptionSet/texCode/art/@listVersion) [Optional]

- nota: *this attribute should always be used coupled with “numberingOrg” and “listName”*



(XPath KnitClothOrder/KCCObody/KCCOitem/phase/garConsumptionSet/yarnCode/art/@listVersion) [Optional]  
- nota: *this attribute should always be used coupled with “numberingOrg” and “listName”*

(XPath KnitClothOrder/KCCObody/KCCOitem/garTecSheet/garConsumptionSet/acsCode/pattern/@listVersion) [Optional]  
- nota: *this attribute should always be used coupled with “numberingOrg” and “listName”*

(XPath KnitClothOrder/KCCObody/KCCOitem/garTecSheet/garConsumptionSet/acsCode/color/@listVersion) [Optional]  
- nota: *this attribute should always be used coupled with “numberingOrg” and “listName”*

(XPath KnitClothOrder/KCCObody/KCCOitem/phase/garConsumptionSet/acsCode/art/@listVersion) [Optional]  
- nota: *this attribute should always be used coupled with “numberingOrg” and “listName”*

(XPath KnitClothOrder/KCCObody/KCCOitem/garTecSheet/garConsumptionSet/garmentCode/garmentCodeB/drop/@listVersion) [Optional] (a)  
- nota: *this attribute should always be used coupled with “numberingOrg” and “listName”*

(XPath KnitClothOrder/KCCObody/KCCOitem/phase/refDoc/season/@listVersion) [Optional]  
- nota: *this attribute should always be used coupled with “numberingOrg” and “listName”*

(XPath KnitClothOrder/KCCObody/KCCOitem/garTecSheet/garConsumptionSet/garmentCode/garmentCodeB/garmentVariant/variantType/@listVersion) [Optional] (a)  
- nota: *this attribute should always be used coupled with “numberingOrg” and “listName”*

(XPath KnitClothOrder/KCCObody/KCCOitem/garTecSheet/garConsumptionSet/garmentCode/garmentCodeB/garmentVariant/variantCode/@listVersion) [Optional] (a)  
- nota: *this attribute should always be used coupled with “numberingOrg” and “listName”*

(XPath KnitClothOrder/KCCObody/KCCOitem/progress/qualityLevel/@listVersion) [Optional]  
- nota: *this attribute should always be used coupled with “numberingOrg” and “listName”*

(XPath KnitClothOrder/KCCObody/KCCOitem/garTecSheet/garConsumptionSet/garConsumption/garSizeCode/@listVersion) [Optional] (a)  
- nota: *this attribute should always be used coupled with “numberingOrg” and “listName”*

(XPath KnitClothOrder/KCCObody/KCCOitem/progress/itemsList/qualityLevel/@listVersion) [Optional] (a)  
- nota: *this attribute should always be used coupled with “numberingOrg” and “listName”*

(XPath KnitClothOrder/KCCObody/KCCOitem/garTecSheet/garConsumptionSet/garmentCode/garmentCodeA/art/@listVersion) [Optional]  
- nota: *this attribute should always be used coupled with “numberingOrg” and “listName”*

(XPath KnitClothOrder/KCCObody/KCCOitem/garTecSheet/garConsumptionSet/garmentCode/garmentCodeB/size/@listVersion) [Optional] (a)  
- nota: *this attribute should always be used coupled with “numberingOrg” and “listName”*

(XPath KnitClothOrder/KCCObody/KCCOitem/garTecSheet/garConsumptionSet/garmentCode/garmentCodeB/artGroup/@listVersion) [Optional]  
- nota: *this attribute should always be used coupled with “numberingOrg” and “listName”*

(XPath KnitClothOrder/KCCObody/KCCOitem/garTecSheet/garConsumptionSet/garmentPartCode/size/@listVersion) [Optional] (a)  
- nota: *this attribute should always be used coupled with “numberingOrg” and “listName”*  
(XPath KnitClothOrder/KCCObody/KCCOitem/phase/garConsumptionSet/acsCode/color/@listVersion) [Optional]  
- nota: *this attribute should always be used coupled with “numberingOrg” and “listName”*  
(XPath KnitClothOrder/KCCObody/KCCOitem/garTecSheet/garConsumptionSet/garmentPartCode/color/@listVersion) [Optional]  
- nota: *this attribute should always be used coupled with “numberingOrg” and “listName”*  
(XPath KnitClothOrder/KCCObody/KCCOitem/garTecSheet/garConsumptionSet/garmentPartCode/fabric/@listVersion) [Optional]  
- nota: *this attribute should always be used coupled with “numberingOrg” and “listName”*  
(XPath KnitClothOrder/KCCObody/KCCOitem/phase/lotDetails/csRange/sizeMatrix/sizeRow/itemsList/qualityLevel/@listVersion) [Optional] (a)  
- nota: *this attribute should always be used coupled with “numberingOrg” and “listName”*  
(XPath KnitClothOrder/KCCObody/KCCOitem/garTecSheet/garConsumptionSet/garmentCode/garmentCodeB/mod/@listVersion) [Optional]  
- nota: *this attribute should always be used coupled with “numberingOrg” and “listName”*  
(XPath KnitClothOrder/KCCObody/KCCOitem/garTecSheet/garConsumptionSet/garmentCode/garmentCodeB/color/@listVersion) [Optional]  
- nota: *this attribute should always be used coupled with “numberingOrg” and “listName”*  
(XPath KnitClothOrder/KCCObody/KCCOitem/phase/garConsumptionSet/acsCode/pattern/@listVersion) [Optional]  
- nota: *this attribute should always be used coupled with “numberingOrg” and “listName”*  
(XPath KnitClothOrder/KCCObody/KCCOitem/apparelComponent/yarnComponent/yarnCode/art/@listVersion) [Optional]  
- nota: *this attribute should always be used coupled with “numberingOrg” and “listName”*  
(XPath KnitClothOrder/KCCObody/KCCOitem/apparelComponent/yarnComponent/yarnCode/color/@listVersion) [Optional]  
- nota: *this attribute should always be used coupled with “numberingOrg” and “listName”*  
(XPath KnitClothOrder/KCCObody/KCCOitem/garTecSheet/garConsumptionSet/garmentCode/garmentCodeB/fabric/@listVersion) [Optional]  
- nota: *this attribute should always be used coupled with “numberingOrg” and “listName”*  
(XPath KnitClothOrder/KCCObody/KCCOitem/garTecSheet/garSizeSet/garSizeTier/garSizeCode/@listVersion) [Optional] (a)  
- nota: *this attribute should always be used coupled with “numberingOrg” and “listName”*  
(XPath KnitClothOrder/KCCObody/KCCOitem/apparelComponent/fabricComponent/refDoc/season/@listVersion) [Optional] (a)  
- nota: *this attribute should always be used coupled with “numberingOrg” and “listName”*  
(XPath KnitClothOrder/KCCObody/KCCOitem/phase/garConsumptionSet/garmentCode/garmentCodeB/garmentVariant/variantType/@listVersion) [Optional] (a)  
- nota: *this attribute should always be used coupled with “numberingOrg” and “listName”*  
(XPath KnitClothOrder/KCCObody/KCCOitem/garTecSheet/garmentCode/garmentCodeB/fabric/@listVersion) [Optional]



- nota: *this attribute should always be used coupled with “numberingOrg” and “listName”*  
(XPath KnitClothOrder/KCCObody/KCCOitem/phase/phaseCode/@listVersion) [Optional] (a)

- nota: *this attribute should always be used coupled with “numberingOrg” and “listName”*  
(XPath KnitClothOrder/KCCObody/KCCOitem/garTecSheet/garmentCode/garmentCodeB/mod/@listVersion) [Optional]

- nota: *this attribute should always be used coupled with “numberingOrg” and “listName”*  
(XPath KnitClothOrder/KCCObody/KCCOitem/garTecSheet/garmentCode/garmentCodeB/color/@listVersion) [Optional]

- nota: *this attribute should always be used coupled with “numberingOrg” and “listName”*  
(XPath KnitClothOrder/KCCObody/KCCOitem/garTecSheet/garmentCode/garmentCodeB/drop/@listVersion) [Optional] (a)

- nota: *this attribute should always be used coupled with “numberingOrg” and “listName”*  
(XPath KnitClothOrder/KCCObody/KCCOitem/garTecSheet/garmentCode/garmentCodeB/size/@listVersion) [Optional] (a)

- nota: *this attribute should always be used coupled with “numberingOrg” and “listName”*  
(XPath KnitClothOrder/KCCObody/KCCOitem/garTecSheet/garmentCode/garmentCodeB/garmentVariant/variantCode/@listVersion) [Optional] (a)

- nota: *this attribute should always be used coupled with “numberingOrg” and “listName”*  
(XPath KnitClothOrder/KCCObody/KCCOitem/garTecSheet/garmentCode/garmentCodeB/garmentVariant/variantType/@listVersion) [Optional] (a)

- nota: *this attribute should always be used coupled with “numberingOrg” and “listName”*  
(XPath KnitClothOrder/KCCObody/KCCOitem/phase/garConsumptionSet/garmentCode/garmentCodeB/color/@listVersion) [Optional]

- nota: *this attribute should always be used coupled with “numberingOrg” and “listName”*  
(XPath KnitClothOrder/KCCObody/KCCOitem/apparelProd/csRange/sizeMatrix/sizeRow/drop/@listVersion) [Optional] (a)

- nota: *this attribute should always be used coupled with “numberingOrg” and “listName”*  
(XPath KnitClothOrder/KCCObody/KCCOitem/apparelProd/csRange/sizeMatrix/sizeRow/size/@listVersion) [Optional] (a)

- nota: *this attribute should always be used coupled with “numberingOrg” and “listName”*  
(XPath KnitClothOrder/KCCObody/KCCOitem/apparelProd/csRange/sizeMatrix/sizeRow/additionalComponentCode/@listVersion) [Optional] (a)

- nota: *this attribute should always be used coupled with “numberingOrg” and “listName”*  
(XPath KnitClothOrder/KCCObody/KCCOitem/phase/garConsumptionSet/garConsumption/garSizeCode/@listVersion) [Optional] (a)

- nota: *this attribute should always be used coupled with “numberingOrg” and “listName”*  
(XPath KnitClothOrder/KCCObody/KCCOitem/apparelProd/csRange/drop/@listVersion) [Optional] (a)

- nota: *this attribute should always be used coupled with “numberingOrg” and “listName”*  
(XPath KnitClothOrder/KCCObody/KCCOitem/apparelProd/csRange/sizeMatrix/sizeRow/itemsList/qualityLevel/@listVersion) [Optional] (a)

- nota: *this attribute should always be used coupled with “numberingOrg” and “listName”*

(XPath  
KnitClothOrder/KCCObody/KCCOitem/phase/garConsumptionSet/garmentCode/garmentCodeB/drop/@listVersion) [Optional] (a)  
- nota: *this attribute should always be used coupled with “numberingOrg” and “listName”*

(XPath  
KnitClothOrder/KCCObody/KCCOitem/phase/garConsumptionSet/garmentCode/garmentCodeB/garmentVariant/variantCode/@listVersion) [Optional] (a)  
- nota: *this attribute should always be used coupled with “numberingOrg” and “listName”*

(XPath  
KnitClothOrder/KCCObody/KCCOitem/phase/garConsumptionSet/garmentCode/garmentCodeB/size/@listVersion) [Optional] (a)  
- nota: *this attribute should always be used coupled with “numberingOrg” and “listName”*

(XPath  
KnitClothOrder/KCCObody/KCCOitem/phase/garConsumptionSet/garmentCode/garmentCodeA/art/@listVersion) [Optional]  
- nota: *this attribute should always be used coupled with “numberingOrg” and “listName”*

(XPath  
KnitClothOrder/KCCObody/KCCOitem/phase/garConsumptionSet/garmentCode/garmentCodeB/artGroup/@listVersion) [Optional]  
- nota: *this attribute should always be used coupled with “numberingOrg” and “listName”*

(XPath KnitClothOrder/KCCObody/KCCOitem/apparelComponent/fabricComponent/texCode/color/@listVersion) [Optional]  
- nota: *this attribute should always be used coupled with “numberingOrg” and “listName”*

(XPath  
KnitClothOrder/KCCObody/KCCOitem/phase/garConsumptionSet/garmentP artCode/size/@listVersion) [Optional] (a)  
- nota: *this attribute should always be used coupled with “numberingOrg” and “listName”*

(XPath KnitClothOrder/KCCOheader/refDoc/season/@listVersion) [Optional] (a)  
- nota: *this attribute should always be used coupled with “numberingOrg” and “listName”*

(XPath KnitClothOrder/KCCObody/KCCOitem/phase/lotDetails/csRange/garmentVariant/variantType/@listVersion) [Optional] (a)  
- nota: *this attribute should always be used coupled with “numberingOrg” and “listName”*

(XPath KnitClothOrder/KCCObody/KCCOitem/garTecSheet/refDoc/season/@listVersion) [Optional] (a)  
- nota: *this attribute should always be used coupled with “numberingOrg” and “listName”*

(XPath  
KnitClothOrder/KCCObody/KCCOitem/phase/garConsumptionSet/garmentP artCode/fabric/@listVersion) [Optional]  
- nota: *this attribute should always be used coupled with “numberingOrg” and “listName”*

(XPath KnitClothOrder/KCCObody/KCCOitem/apparelComponent/fabricComponent/texCode/art/@listVersion) [Optional]  
- nota: *this attribute should always be used coupled with “numberingOrg” and “listName”*

(XPath  
KnitClothOrder/KCCObody/KCCOitem/phase/garConsumptionSet/garmentP artCode/color/@listVersion) [Optional]  
- nota: *this attribute should always be used coupled with “numberingOrg” and “listName”*

(XPath KnitClothOrder/KCCObody/KCCOitem/phase/lotDetails/csRange/garmentVariant/variantCode/@listVersion) [Optional] (a)  
- nota: *this attribute should always be used coupled with “numberingOrg” and “listName”*

(XPath KnitClothOrder/KCCObody/KCCOitem/apparelComponent/fabricComponent/texCode/pattern/@listVersion) [Optional]

	<p>- nota: <i>this attribute should always be used coupled with “numberingOrg” and “listName”</i>  (XPath KnitClothOrder/KCCObody/KCCOitem/phase/lotDetails/csRange/color/@listVersion) [Optional]</p> <p>- nota: <i>this attribute should always be used coupled with “numberingOrg” and “listName”</i>  (XPath KnitClothOrder/KCCObody/KCCOitem/packages/handlingChar/garPack/garPackCode/@listVersion) [Optional] (a)</p> <p>- nota: <i>this attribute should always be used coupled with “numberingOrg” and “listName”</i>  (XPath KnitClothOrder/KCCObody/KCCOitem/garTecSheet/garmentCode/garmentCodeB/artGroup/@listVersion) [Optional]</p> <p>- nota: <i>this attribute should always be used coupled with “numberingOrg” and “listName”</i>  (XPath KnitClothOrder/KCCObody/KCCOitem/apparelComponent/fabricComponent/itemsList/qualityLevel/@listVersion) [Optional] (a)</p> <p>- nota: <i>this attribute should always be used coupled with “numberingOrg” and “listName”</i>  (XPath KnitClothOrder/KCCObody/KCCOitem/phase/garConsumptionSet/garmentCode/garmentCodeB/fabric/@listVersion) [Optional]</p> <p>- nota: <i>this attribute should always be used coupled with “numberingOrg” and “listName”</i>  (XPath KnitClothOrder/KCCObody/KCCOitem/garTecSheet/garmentCode/garmentCodeA/art/@listVersion) [Optional]</p> <p>- nota: <i>this attribute should always be used coupled with “numberingOrg” and “listName”</i>  (XPath KnitClothOrder/KCCObody/KCCOitem/phase/garConsumptionSet/garmentCode/garmentCodeB/mod/@listVersion) [Optional]</p> <p>- nota: <i>this attribute should always be used coupled with “numberingOrg” and “listName”</i></p>
@In	<p>Language code.</p> <p>- base type: string, cod. table: NT60  <a href="http://www.ebiz.enea.it/moda-ml/repository/codelist/v2018-1/gc_NT60.xml">http://www.ebiz.enea.it/moda-ml/repository/codelist/v2018-1/gc_NT60.xml</a></p> <p>(XPath KnitClothOrder/KCCObody/KCCOitem/phase/garConsumptionSet/garmentPartCode/description/@In) [Optional] (N)</p> <p>(XPath KnitClothOrder/KCCObody/KCCOitem/phase/garConsumptionSet/yarnCode/description/@In) [Optional] (N)</p> <p>(XPath KnitClothOrder/KCCObody/KCCOitem/phase/packages/handlingChar/handlingType/@In) [Optional] (Na)</p> <p>(XPath KnitClothOrder/KCCObody/KCCOitem/packages/description/@In) [Optional] (N)</p> <p>(XPath KnitClothOrder/KCCObody/KCCOitem/packages/handlingChar/handlingType/@In) [Optional] (Na)</p> <p>(XPath KnitClothOrder/KCCObody/KCCOitem/phase/garConsumptionSet/texCode/description/@In) [Optional] (N)</p> <p>(XPath KnitClothOrder/KCCObody/KCCOitem/phase/garConsumptionSet/garmentCode/garmentCodeB/description/@In) [Optional] (N)</p> <p>(XPath KnitClothOrder/KCCObody/KCCOitem/phase/garConsumptionSet/acsCode/description/@In) [Optional] (N)</p> <p>(XPath KnitClothOrder/KCCObody/KCCOitem/phase/packages/description/@In) [Optional] (N)</p> <p>(XPath KnitClothOrder/KCCObody/KCCOitem/phase/garConsumptionSet/garmentCode/garmentCodeA/description/@In) [Optional] (N)</p> <p>(XPath KnitClothOrder/KCCObody/KCCOitem/garTecSheet/garConsumptionSet/garmentCode/garmentCodeB/description/@In) [Optional] (N)</p>

	<p>(XPath KnitClothOrder/KCCObody/KCCOitem/garTecSheet/garConsumptionSet/garmentCode/garmentCodeA/description/@In) [Optional] (N)</p> <p>(XPath KnitClothOrder/KCCObody/KCCOitem/garTecSheet/garmentCode/garmentCodeA/description/@In) [Optional] (N)</p> <p>(XPath KnitClothOrder/KCCObody/KCCOitem/garTecSheet/garmentCode/garmentCodeB/description/@In) [Optional] (N)</p> <p>(XPath KnitClothOrder/KCCObody/KCCOitem/apparelProd/garmentCode/garmentCodeB/description/@In) [Optional] (N)</p> <p>(XPath KnitClothOrder/KCCObody/KCCOitem/apparelProd/garmentCode/garmentCodeA/description/@In) [Optional] (N)</p> <p>(XPath KnitClothOrder/KCCObody/KCCOitem/apparelProd/garmentPartCode/description/@In) [Optional] (N)</p> <p>(XPath KnitClothOrder/KCCObody/KCCOitem/apparelComponent/yarnComponent/yarnCode/description/@In) [Optional] (N)</p> <p>(XPath KnitClothOrder/KCCObody/KCCOitem/apparelComponent/acsComponent/acsCode/description/@In) [Optional] (N)</p> <p>(XPath KnitClothOrder/KCCObody/KCCOitem/garTecSheet/garConsumptionSet/garmentPartCode/description/@In) [Optional] (N)</p> <p>(XPath KnitClothOrder/KCCObody/KCCOitem/apparelComponent/garmentPartComponent/garmentPartCode/description/@In) [Optional] (N)</p> <p>(XPath KnitClothOrder/KCCObody/KCCOitem/garTecSheet/garConsumptionSet/yarnCode/description/@In) [Optional] (N)</p> <p>(XPath KnitClothOrder/KCCObody/KCCOitem/apparelComponent/fabricComponent/texCode/description/@In) [Optional] (N)</p> <p>(XPath KnitClothOrder/KCCObody/KCCOitem/garTecSheet/garConsumptionSet/texCode/description/@In) [Optional] (N)</p> <p>(XPath KnitClothOrder/KCCObody/KCCOitem/garTecSheet/garConsumptionSet/acsCode/description/@In) [Optional] (N)</p>
location	<p>specification of a location</p> <p>- base type: string, max length: 40,</p> <p>(XPath KnitClothOrder/KCCObody/KCCOitem/apparelComponent/garmentPartComponent/location) 0-1</p> <p>(XPath KnitClothOrder/KCCObody/KCCOitem/apparelComponent/acsComponent/location) 0-1</p> <p>(XPath KnitClothOrder/KCCObody/KCCOitem/apparelComponent/fabricComponent/location) 0-1</p> <p>- note: <i>it may be used to specify the location where lie the pieces that the Subcontractor must use for the commissioned work operation</i></p> <p>(XPath KnitClothOrder/terms/trade/location) 0-1</p> <p>- note: <i>place to which the INCOTERM applies</i></p> <p>(XPath KnitClothOrder/KCCObody/KCCOitem/apparelComponent/yarnComponent/location) 0-1</p> <p>- note: <i>here the storage place of the component can be specified</i></p>
@logo	<p>company logo (URL of the image jpeg or gif). It is recommended that the width of the image does not exceed 640 pixel.</p> <p>- base type: string, max length: 255,</p> <p>(XPath KnitClothOrder/KCCOheader/buyer/@logo) [Optional]</p>
lotN	<p>lot number of a product or batch number of the raw material</p> <p>- base type: string, max length: 15,</p> <p>(XPath KnitClothOrder/KCCObody/KCCOitem/garTecSheet/garConsumptionSet/lotN) 0-99</p> <p>(XPath KnitClothOrder/KCCObody/KCCOitem/phase/garConsumptionSet/lotN) 0-99</p> <p>(XPath KnitClothOrder/KCCObody/KCCOitem/apparelComponent/yarnComponent/lotN) 0-1</p> <p>(XPath KnitClothOrder/KCCObody/KCCOitem/apparelComponent/garmentPartComponent/lotN) 0-1</p> <p>(XPath KnitClothOrder/KCCObody/KCCOitem/phase/lotDetails/lotN) 1-1</p> <p>(XPath KnitClothOrder/KCCObody/KCCOitem/apparelComponent/acsComponent/lotN) 0-1</p> <p>(XPath KnitClothOrder/KCCObody/KCCOitem/apparelProd/lotN) 0-1</p>

@LRI	<p>attribute usable to format a string according to a customized User rule (local rule)</p> <p>- base type: string, cod. table: NT3  <a href="http://www.ebiz.enea.it/moda-ml/repository/codelist/v2018-1/gc_NT3.xml">http://www.ebiz.enea.it/moda-ml/repository/codelist/v2018-1/gc_NT3.xml</a>  (XPath KnitClothOrder/KCCObody/KCCOitem/apparelComponent/yarnComponent/location/@LRI) [Optional]  (XPath KnitClothOrder/terms/trade/location/@LRI) [Optional]  (XPath KnitClothOrder/KCCObody/KCCOitem/apparelComponent/garmentPartComponent/location/@LRI) [Optional]  (XPath KnitClothOrder/KCCObody/KCCOitem/apparelComponent/fabricComponent/location/@LRI) [Optional]  (XPath KnitClothOrder/KCCObody/KCCOitem/apparelComponent/acsComponent/location/@LRI) [Optional]</p>
@maxQty	<p>maximum product quantity</p> <p>- base type: decimal, min inclusive: 0, fraction digits: 2,  (XPath KnitClothOrder/terms/allowanceCharge/@maxQty) [Optional] (N)  - nota: <i>maximum quantity of product for the application of this allowance or charge</i></p>
@method	<p>standard protocol or method employed in a test to evaluate a characteristic or a parameter</p> <p>- base type: string, max length: 80,  (XPath KnitClothOrder/KCCObody/KCCOitem/garTecSheet/garMeaSet/garMea/specValue/@method) [Optional]</p>
mfrStatus	<p>code of the manufacturing stage used to describe the progress in the production cycle</p> <p>- base type: string, cod. table: T7  <a href="http://www.ebiz.enea.it/moda-ml/repository/codelist/v2018-1/gc_T7.xml">http://www.ebiz.enea.it/moda-ml/repository/codelist/v2018-1/gc_T7.xml</a>  (XPath KnitClothOrder/KCCObody/KCCOitem/progress/mfrStatus) 0-1</p>
mfrStatusText	<p>free text description of the manufacturing stage used to specify the progress in the production cycle</p> <p>- base type: string, max length: 250,  (XPath KnitClothOrder/KCCObody/KCCOitem/progress/mfrStatusText) 0-1 (U)</p>
@mime	<p>the mime type of the binary object</p> <p>- base type: normalizedString,  (XPath KnitClothOrder/KCCObody/KCCOitem/appMnfrOperation/refDoc/attachment/binaryObject/@mime) [Optional] (Na)  (XPath KnitClothOrder/KCCObody/KCCOitem/phase/refDoc/attachment/binaryObject/@mime) [Optional] (Na)  (XPath KnitClothOrder/KCCObody/KCCOitem/garTecSheet/refDoc/attachment/binaryObject/@mime) [Optional] (Na)  (XPath KnitClothOrder/KCCObody/KCCOitem/apparelComponent/garmentPartComponent/refDoc/attachment/binaryObject/@mime) [Optional] (Na)  (XPath KnitClothOrder/KCCObody/KCCOitem/apparelComponent/yarnComponent/refDoc/attachment/binaryObject/@mime) [Optional] (Na)  (XPath KnitClothOrder/KCCObody/KCCOitem/apparelComponent/acsComponent/refDoc/attachment/binaryObject/@mime) [Optional] (Na)  (XPath KnitClothOrder/KCCObody/KCCOitem/apparelComponent/fabricComponent/refDoc/attachment/binaryObject/@mime) [Optional] (Na)  (XPath KnitClothOrder/KCCOheader/refDoc/attachment/binaryObject/@mime) [Optional] (N)</p>
mimeCode	<p>mime type of the external object</p> <p>- base type: normalizedString,  (XPath KnitClothOrder/KCCObody/KCCOitem/appMnfrOperation/refDoc/attachment/externalReference/mimeCode) 0-1 (N)</p> <hr/> <p>AAAA-WARNING! - text not AVAILABLE n. 245 - In=en  (XPath KnitClothOrder/KCCObody/KCCOitem/apparelComponent/yarnComponent/refDoc/attachment/externalReference/mimeCode) 0-1 (N)</p> <hr/> <p>AAAA-WARNING! - text not AVAILABLE n. 245 - In=en</p>

	<p>(XPath KnitClothOrder/KCCObody/KCCOitem/apparelComponent/fabricComponent/refDoc/attachment/externalReference/mimeType) 0-1 (N)</p> <hr/> <p>AAAA-WARNING! - text not AVAILABLE n. 245 - In=en (XPath KnitClothOrder/KCCObody/KCCOitem/garTecSheet/refDoc/attachment/externalReference/mimeType) 0-1 (N)</p> <hr/> <p>AAAA-WARNING! - text not AVAILABLE n. 245 - In=en (XPath KnitClothOrder/KCCObody/KCCOitem/phase/refDoc/attachment/externalReference/mimeType) 0-1 (N)</p> <hr/> <p>AAAA-WARNING! - text not AVAILABLE n. 245 - In=en (XPath KnitClothOrder/KCCOheader/refDoc/attachment/externalReference/mimeType) 0-1 (N)</p> <hr/> <p>AAAA-WARNING! - text not AVAILABLE n. 245 - In=en (XPath KnitClothOrder/KCCObody/KCCOitem/apparelComponent/garmentPartComponent/refDoc/attachment/externalReference/mimeType) 0-1 (N)</p> <hr/> <p>AAAA-WARNING! - text not AVAILABLE n. 245 - In=en (XPath KnitClothOrder/KCCObody/KCCOitem/apparelComponent/acsComponent/refDoc/attachment/externalReference/mimeType) 0-1 (N)</p> <hr/> <p>AAAA-WARNING! - text not AVAILABLE n. 245 - In=en</p>
minItemsPerPackage	<p>the minimum quantity of items for the specified kind of package. - base type: decimal, min inclusive: 0, (XPath KnitClothOrder/KCCObody/KCCOitem/packages/minItemsPerPackage) 0-1 (N) (XPath KnitClothOrder/KCCObody/KCCOitem/phase/packages/minItemsPerPackage) 0-1 (N)</p>
@minQty	<p>minimum product quantity - base type: decimal, min inclusive: 0, fraction digits: 2, (XPath KnitClothOrder/terms/allowanceCharge/@minQty) [Optional] (a) - nota: <i>minimum quantity of product for the application of this allowance or charge</i></p>
mnfrNote	<p>free text manufacturing note - base type: string, max length: 350, (XPath KnitClothOrder/KCCObody/KCCOitem/garTecSheet/mnfrNote) 0-99</p>
mod	<p>model number of the garment - base type: string, max length: 15, (XPath KnitClothOrder/KCCObody/KCCOitem/apparelProd/garmentPartCode/mod) 1-1 - note: <i>when a garment component, it should be the code assigned to the garment article</i> (XPath KnitClothOrder/KCCObody/KCCOitem/garTecSheet/garConsumptionSet/garmentPartCode/mod) 1-1 - note: <i>when a garment component, it should be the code assigned to the garment article</i> (XPath KnitClothOrder/KCCObody/KCCOitem/garTecSheet/garmentCode/garmentCodeB/mod) 1-1 (XPath KnitClothOrder/KCCObody/KCCOitem/phase/garConsumptionSet/garmentPartCode/mod) 1-1 - note: <i>when a garment component, it should be the code assigned to the garment article</i> (XPath KnitClothOrder/KCCObody/KCCOitem/garTecSheet/garConsumptionSet/garmentCode/garmentCodeB/mod) 1-1 (XPath KnitClothOrder/KCCObody/KCCOitem/apparelComponent/garmentPartComponent/garmentPartCode/mod) 1-1 - note: <i>when a garment component, it should be the code assigned to the garment article</i></p>



	(XPath KnitClothOrder/KCCObody/KCCOitem/apparelProd/garmentCode/garmentCodeB/mod) 1-1 (XPath KnitClothOrder/KCCObody/KCCOitem/phase/garConsumptionSet/garmentCode/garmentCodeB/mod) 1-1
msgCurrency	currency used to express the monetary amounts of the message - base type: string, cod. table: T9 <a href="http://www.ebiz.enea.it/moda-ml/repository/codelist/v2018-1/gc_T9.xml">http://www.ebiz.enea.it/moda-ml/repository/codelist/v2018-1/gc_T9.xml</a> (XPath KnitClothOrder/KCCOheader/msgCurrency) 0-1
msgDate	date of issue of the present message (xml document), according to one of the patterns YYYY-MM-DD, YYYY-MM-DD:HH-MM or YYYY-WW. - base type: string, (XPath KnitClothOrder/KCCOheader/msgDate) 1-1
@msgfunction	function performed by the present message with regards to the transmission - base type: string, cod. table: NT18 <a href="http://www.ebiz.enea.it/moda-ml/repository/codelist/v2018-1/gc_NT18.xml">http://www.ebiz.enea.it/moda-ml/repository/codelist/v2018-1/gc_NT18.xml</a> (XPath KnitClothOrder/@msgfunction) [Optional] [Default= OR]
msgID	key identifier of the business document in the information system of the issuing Party. In case of more despatches of the same business document, it is unchanged. - base type: string, max length: 35, (XPath KnitClothOrder/KCCOheader/msgID) 0-1
msgN	identification number given to the message (xml document) by its issuer. In case of more despatches of the same business document, it changes. - base type: string, max length: 35, (XPath KnitClothOrder/KCCOheader/msgN) 1-1
netWeight	the net weight declared for transport or customs purpose - base type: decimal, min inclusive: 0, fraction digits: 2, (XPath KnitClothOrder/KCCObody/KCCOitem/garTecSheet/netWeight) 0-1 (XPath KnitClothOrder/KCCObody/KCCOitem/packages/handlingChar/netWeight) 0-1 (XPath KnitClothOrder/KCCObody/KCCOitem/phase/packages/handlingChar/netWeight) 0-1 (XPath KnitClothOrder/terms/transInfo/netWeight) 0-1
notBeforeDate	earliest date possible to begin an activity, according to one of the patterns YYYY-MM-DD, YYYY-MM-DD:HH-MM or YYYY-WW. - base type: string, (XPath KnitClothOrder/KCCObody/KCCOitem/phase/notBeforeDate) 0-1 (p)
note	free text or structured (computer processing) note. For note structuring use the attributes "noteLabel" and "codelist" - base type: string, max length: 350, (XPath KnitClothOrder/KCCObody/KCCOitem/garComInfo/note) 0-99 (XPath KnitClothOrder/KCCObody/KCCOitem/dtScheme/note) 0-99 (XPath KnitClothOrder/KCCObody/KCCOitem/apparelComponent/fabricComponent/note) 0-99 (XPath KnitClothOrder/KCCObody/KCCOitem/apparelComponent/acsComponent/note) 0-99 (XPath KnitClothOrder/KCCObody/KCCOitem/phase/note) 0-99 (XPath KnitClothOrder/KCCObody/KCCOitem/apparelComponent/garmentPartComponent/note) 0-99 (XPath KnitClothOrder/garComInfo/note) 0-99 (XPath KnitClothOrder/KCCObody/KCCOitem/packages/handlingChar/note) 0-99 (XPath KnitClothOrder/KCCObody/KCCOitem/phase/packages/handlingChar/note) 0-99 (XPath KnitClothOrder/KCCObody/KCCOitem/apparelComponent/yarnComponent/note) 0-99 (XPath KnitClothOrder/KCCObody/KCCOitem/apparelProd/note) 0-99 (XPath KnitClothOrder/KCCOheader/note) 0-99



	<p>(XPath KnitClothOrder/KCCObody/KCCOitem/note) 0-99  (XPath KnitClothOrder/terms/allowanceCharge/dtScheme/note) 0-99  (XPath KnitClothOrder/KCCObody/KCCOitem/appMnfrOperation/note) 0-99</p>
@noteLabel	<p>subject qualifier of a note</p> <ul style="list-style-type: none"> <li>- base type: string, max length: 35,  (XPath KnitClothOrder/KCCObody/KCCOitem/apparelComponent/yarnComponent/note/@noteLabel) [Optional]</li> <li>- nota: <i>must be used to qualify the subject of the note</i>  (XPath KnitClothOrder/KCCObody/KCCOitem/phase/note/@noteLabel) [Optional]</li> <li>- nota: <i>must be used to qualify the subject of the note</i>  (XPath KnitClothOrder/garComInfo/note/@noteLabel) [Optional]</li> <li>- nota: <i>must be used to qualify the subject of the note</i>  (XPath KnitClothOrder/KCCObody/KCCOitem/packages/handlingChar/note/@noteLabel) [Optional]</li> <li>- nota: <i>must be used to qualify the subject of the note</i>  (XPath KnitClothOrder/KCCObody/KCCOitem/phase/packages/handlingChar/note/@noteLabel) [Optional]</li> <li>- nota: <i>must be used to qualify the subject of the note</i>  (XPath KnitClothOrder/KCCObody/KCCOitem/appMnfrOperation/note/@noteLabel) [Optional]</li> <li>- nota: <i>must be used to qualify the subject of the note</i>  (XPath KnitClothOrder/KCCObody/KCCOitem/apparelProd/note/@noteLabel) [Optional]</li> <li>- nota: <i>must be used to qualify the subject of the note</i>  (XPath KnitClothOrder/KCCObody/KCCOitem/apparelComponent/fabricComponent/note/@noteLabel) [Optional]</li> <li>- nota: <i>must be used to qualify the subject of the note</i>  (XPath KnitClothOrder/KCCOheader/note/@noteLabel) [Optional]</li> <li>- nota: <i>must be used to qualify the subject of the note</i>  (XPath KnitClothOrder/KCCObody/KCCOitem/note/@noteLabel) [Optional]</li> <li>- nota: <i>must be used to qualify the subject of the note</i>  (XPath KnitClothOrder/KCCObody/KCCOitem/apparelComponent/garmentPartComponent/note/@noteLabel) [Optional]</li> <li>- nota: <i>must be used to qualify the subject of the note</i>  (XPath KnitClothOrder/KCCObody/KCCOitem/garComInfo/note/@noteLabel) [Optional]</li> <li>- nota: <i>must be used to qualify the subject of the note</i>  (XPath KnitClothOrder/terms/allowanceCharge/dtScheme/note/@noteLabel) [Optional]</li> <li>- nota: <i>must be used to qualify the subject of the note</i>  (XPath KnitClothOrder/KCCObody/KCCOitem/dtScheme/note/@noteLabel) [Optional]</li> <li>- nota: <i>must be used to qualify the subject of the note</i>  (XPath KnitClothOrder/KCCObody/KCCOitem/apparelComponent/acsComponent/note/@noteLabel) [Optional]</li> <li>- nota: <i>must be used to qualify the subject of the note</i></li> </ul>
@numberingOrg	<p>code specifying the organisation who has created or owns the coding or numbering system</p> <ul style="list-style-type: none"> <li>- base type: string, cod. table: NT6  <a href="http://www.ebiz.enea.it/moda-ml/repository/codelist/v2018-1/gc_NT6.xml">http://www.ebiz.enea.it/moda-ml/repository/codelist/v2018-1/gc_NT6.xml</a>  (XPath KnitClothOrder/KCCObody/KCCOitem/phase/garConsumptionSet/garmentCode/garmentCodeB/garmentVariant/variantType/@numberingOrg) [Optional] (a)</li> <li>- nota: <i>this attribute should be used either single or coupled with "listName" and "listVersion"</i>  (XPath KnitClothOrder/KCCObody/KCCOitem/garTecSheet/garmentCode/garmentCodeB/garmentVariant/variantType/@numberingOrg) [Optional] (a)</li> <li>- nota: <i>this attribute should be used either single or coupled with "listName" and "listVersion"</i>  (XPath KnitClothOrder/KCCOheader/season/@numberingOrg) [Optional] (a)</li> <li>- nota: <i>this attribute should be used either single or coupled with "listName" and "listVersion"</i></li> </ul>

(XPath KnitClothOrder/KCCObody/KCCOitem/garTecSheet/  
garmentCode/garmentCodeB/drop/@numberingOrg) [Optional] (a)  
- nota: *this attribute should be used either single or coupled with "listName"  
and "listVersion"*

(XPath KnitClothOrder/KCCObody/KCCOitem/garTecSheet/  
garmentCode/garmentCodeB/garmentVariant/variantCode/@numberingOrg)  
[Optional] (a)  
- nota: *this attribute should be used either single or coupled with "listName"  
and "listVersion"*

(XPath  
KnitClothOrder/KCCObody/KCCOitem/phase/garConsumptionSet/garmentC  
ode/garmentCodeB/added/@numberingOrg) [Optional]  
- nota: *this attribute should be used either single or coupled with "listName"  
and "listVersion"*

(XPath KnitClothOrder/KCCObody/KCCOitem/apparelProd/note/@numberingOrg) [O  
ptional]  
- nota: *must be used to specify the organization that created the list of code  
s used in "noteLabel"*

(XPath  
KnitClothOrder/KCCObody/KCCOitem/phase/garConsumptionSet/garmentC  
ode/garmentCodeB/artGroup/@numberingOrg) [Optional]  
- nota: *this attribute should be used either single or coupled with "listName"  
and "listVersion"*

(XPath KnitClothOrder/KCCObody/KCCOitem/thirdParty/id/@numberingOrg) [Option  
al]  
(XPath KnitClothOrder/KCCObody/KCCOitem/apparelProd/  
csRange/sizeMatrix/sizeRow/itemsList/qualityLevel/@numberingOrg) [Option  
al] (a)  
- nota: *this attribute should be used either single or coupled with "listName"  
and "listVersion"*

(XPath KnitClothOrder/KCCObody/KCCOitem/packages/  
EPClist/EPC/@numberingOrg) [Optional]  
(XPath  
KnitClothOrder/KCCObody/KCCOitem/phase/garConsumptionSet/garmentC  
ode/garmentCodeA/art/@numberingOrg) [Optional]  
- nota: *this attribute should be used either single or coupled with "listName"  
and "listVersion"*

(XPath KnitClothOrder/KCCObody/KCCOitem/apparelProd/  
csRange/sizeMatrix/sizeRow/itemsList/itemIdentification/serialN/@numberin  
gOrg) [Optional]  
- nota: *here the issuer of the serial number must be specified (when differen  
t from the Supplier)*

(XPath  
KnitClothOrder/KCCObody/KCCOitem/phase/garConsumptionSet/garmentC  
ode/garmentCodeB/size/@numberingOrg) [Optional] (a)  
- nota: *this attribute should be used either single or coupled with "listName"  
and "listVersion"*

(XPath KnitClothOrder/KCCObody/KCCOitem/garTecSheet/  
garmentCode/garmentCodeB/fabric/@numberingOrg) [Optional]  
- nota: *this attribute should be used either single or coupled with "listName"  
and "listVersion"*

(XPath KnitClothOrder/KCCObody/KCCOitem/garTecSheet/  
garmentCode/garmentCodeB/mod/@numberingOrg) [Optional]  
(XPath KnitClothOrder/KCCObody/KCCOitem/garTecSheet/  
garmentCode/garmentCodeB/color/@numberingOrg) [Optional]  
- nota: *this attribute should be used either single or coupled with "listName"  
and "listVersion"*

(XPath  
KnitClothOrder/KCCObody/KCCOitem/phase/garConsumptionSet/garmentC  
ode/garmentCodeB/garmentVariant/variantCode/@numberingOrg) [Optional] (a)  
- nota: *this attribute should be used either single or coupled with "listName"  
and "listVersion"*

(XPath KnitClothOrder/KCCObody/KCCOitem/garTecSheet/  
garmentCode/@numberingOrg) [Optional]

	<p>(XPath KnitClothOrder/KCCObody/KCCOitem/phase/garConsumptionSet/lotN/@numberingOrg) [Optional]</p> <p>(XPath KnitClothOrder/KCCObody/KCCOitem/garTecSheet/garmentCode/garmentCodeB/@numberingOrg) [Optional]</p> <p>(XPath KnitClothOrder/KCCObody/KCCOitem/phase/garConsumptionSet/garmentCode/garmentCodeB/drop/@numberingOrg) [Optional] (a) - nota: <i>this attribute should be used either single or coupled with "listName" and "listVersion"</i></p> <p>(XPath KnitClothOrder/KCCOheader/docID/@numberingOrg) [Optional] - nota: <i>here can be specified whose document numbering is used (e.g.: Client, Supplier, ..)</i></p> <p>(XPath KnitClothOrder/KCCObody/KCCOitem/phase/garConsumptionSet/yarnCode/added/@numberingOrg) [Optional] - nota: <i>this attribute should be used either single or coupled with "listName" and "listVersion"</i></p> <p>(XPath KnitClothOrder/KCCObody/KCCOitem/garTecSheet/garConsumptionSet/acsCode/@numberingOrg) [Optional]</p> <p>(XPath KnitClothOrder/KCCObody/KCCOitem/garTecSheet/garConsumptionSet/acsCode/pattern/@numberingOrg) [Optional] - nota: <i>this attribute should be used either single or coupled with "listName" and "listVersion"</i></p> <p>(XPath KnitClothOrder/KCCObody/KCCOitem/garTecSheet/garConsumptionSet/acsCode/art/@numberingOrg) [Optional] - nota: <i>this attribute should be used either single or coupled with "listName" and "listVersion"</i></p> <p>(XPath KnitClothOrder/KCCObody/KCCOitem/phase/garConsumptionSet/garmentPartCode/@numberingOrg) [Optional]</p> <p>(XPath KnitClothOrder/KCCObody/KCCOitem/phase/garConsumptionSet/garmentPartCode/fabric/@numberingOrg) [Optional] - nota: <i>this attribute should be used either single or coupled with "listName" and "listVersion"</i></p> <p>(XPath KnitClothOrder/KCCObody/KCCOitem/garTecSheet/garSizeSet/garSizeTier/garSizeCode/@numberingOrg) [Optional] (a) - nota: <i>this attribute should be used either single or coupled with "listName" and "listVersion"</i></p> <p>(XPath KnitClothOrder/KCCObody/KCCOitem/phase/garConsumptionSet/garmentPartCode/mod/@numberingOrg) [Optional]</p> <p>(XPath KnitClothOrder/KCCObody/KCCOitem/garTecSheet/garMeaSet/garMea/size/@numberingOrg) [Optional] (a) - nota: <i>this attribute should be used either single or coupled with "listName" and "listVersion"</i></p> <p>(XPath KnitClothOrder/KCCObody/KCCOitem/phase/garConsumptionSet/yarnCode/art/@numberingOrg) [Optional] - nota: <i>this attribute should be used either single or coupled with "listName" and "listVersion"</i></p> <p>(XPath KnitClothOrder/KCCObody/KCCOitem/garTecSheet/garConsumptionSet/texCode/art/@numberingOrg) [Optional] - nota: <i>this attribute should be used either single or coupled with "listName" and "listVersion"</i></p> <p>(XPath KnitClothOrder/KCCObody/KCCOitem/garTecSheet/garConsumptionSet/texCode/pattern/@numberingOrg) [Optional] - nota: <i>this attribute should be used either single or coupled with "listName" and "listVersion"</i></p> <p>(XPath KnitClothOrder/KCCObody/KCCOitem/phase/garConsumptionSet/yarnCode/@numberingOrg) [Optional] [Default= CL]</p> <p>(XPath KnitClothOrder/KCCObody/KCCOitem/garTecSheet/garConsumptionSet/texCode/@numberingOrg) [Optional]</p>
--	--

(XPath KnitClothOrder/KCCObody/KCCOitem/note/@numberingOrg) [Optional]  
- nota: *must be used to specify the organization that created the list of code s used in "noteLabel"*

(XPath KnitClothOrder/KCCObody/KCCOitem/garTecSheet/garConsumptionSet/acsCode/color/@numberingOrg) [Optional]  
- nota: *this attribute should be used either single or coupled with "listName" and "listVersion"*

(XPath KnitClothOrder/KCCObody/KCCOitem/garTecSheet/garConsumptionSet/acsCode/added/@numberingOrg) [Optional]  
- nota: *this attribute should be used either single or coupled with "listName" and "listVersion"*

(XPath KnitClothOrder/KCCObody/KCCOitem/phase/garConsumptionSet/yarnCode/color/@numberingOrg) [Optional]  
- nota: *this attribute should be used either single or coupled with "listName" and "listVersion"*

(XPath KnitClothOrder/KCCObody/KCCOitem/garTecSheet/garmentCode/garmentCodeA/art/@numberingOrg) [Optional]  
- nota: *this attribute should be used either single or coupled with "listName" and "listVersion"*

(XPath KnitClothOrder/KCCObody/KCCOitem/phase/garConsumptionSet/garmentCode/garmentCodeB/fabric/@numberingOrg) [Optional]  
- nota: *this attribute should be used either single or coupled with "listName" and "listVersion"*

(XPath KnitClothOrder/KCCObody/KCCOitem/phase/garConsumptionSet/garmentCode/garmentCodeB/mod/@numberingOrg) [Optional]  
(XPath KnitClothOrder/KCCObody/KCCOitem/garTecSheet/refDoc/docID/@numberingOrg) [Optional]  
- nota: *here can be specified whose document numbering is used (e.g.: Client, Supplier, ..)*

(XPath KnitClothOrder/KCCObody/KCCOitem/garTecSheet/garmentCode/garmentCodeB/added/@numberingOrg) [Optional]  
- nota: *this attribute should be used either single or coupled with "listName" and "listVersion"*

(XPath KnitClothOrder/KCCObody/KCCOitem/garTecSheet/garmentCode/garmentCodeB/size/@numberingOrg) [Optional] (a)  
- nota: *this attribute should be used either single or coupled with "listName" and "listVersion"*

(XPath KnitClothOrder/KCCObody/KCCOitem/phase/garConsumptionSet/garmentCode/garmentCodeB/color/@numberingOrg) [Optional]  
- nota: *this attribute should be used either single or coupled with "listName" and "listVersion"*

(XPath KnitClothOrder/KCCObody/KCCOitem/dtScheme/legalRef/@numberingOrg) [Optional] (a)  
- nota: *this attribute should be used either single or coupled with "listName" and "listVersion"*

(XPath KnitClothOrder/KCCObody/KCCOitem/garTecSheet/garmentCode/garmentCodeB/artGroup/@numberingOrg) [Optional]  
- nota: *this attribute should be used either single or coupled with "listName" and "listVersion"*

(XPath KnitClothOrder/KCCObody/KCCOitem/phase/garConsumptionSet/garmentPartCode/added/@numberingOrg) [Optional]  
- nota: *this attribute should be used either single or coupled with "listName" and "listVersion"*

(XPath KnitClothOrder/KCCObody/KCCOitem/phase/garConsumptionSet/garmentPartCode/size/@numberingOrg) [Optional] (a)  
- nota: *this attribute should be used either single or coupled with "listName" and "listVersion"*

	<p>(XPath KnitClothOrder/KCCObody/KCCOitem/phase/garConsumptionSet/garmentPartCode/color/@numberingOrg) [Optional]  - nota: <i>this attribute should be used either single or coupled with "listName" and "listVersion"</i></p> <p>(XPath KnitClothOrder/KCCObody/KCCOitem/garTecSheet/garSizeSet/@numberingOrg) [Optional]  (XPath KnitClothOrder/KCCObody/KCCOitem/dtScheme/note/@numberingOrg) [Optional]  - nota: <i>must be used to specify the organization that created the list of code s used in "noteLabel"</i></p> <p>(XPath KnitClothOrder/KCCObody/KCCOitem/garTecSheet/refDoc/season/@numberingOrg) [Optional] (a)  - nota: <i>this attribute should be used either single or coupled with "listName" and "listVersion"</i></p> <p>(XPath KnitClothOrder/KCCObody/KCCOitem/phase/garConsumptionSet/garmentCode/garmentCodeB/@numberingOrg) [Optional]  (XPath KnitClothOrder/KCCObody/KCCOitem/garTecSheet/refDoc/attachment/fileName/@numberingOrg) [Optional] (a)  (XPath KnitClothOrder/KCCObody/KCCOitem/phase/garConsumptionSet/garmentCode/@numberingOrg) [Optional]  (XPath KnitClothOrder/garComInfo/operationalCode/@numberingOrg) [Optional] (a)  - nota: <i>this attribute should be used either single or coupled with "listName" and "listVersion"</i></p> <p>(XPath KnitClothOrder/garComInfo/productLine/@numberingOrg) [Optional] (a)  - nota: <i>this attribute should be used either single or coupled with "listName" and "listVersion"</i></p> <p>(XPath KnitClothOrder/garComInfo/acsPack/acsPackCode/@numberingOrg) [Optional] (a)  - nota: <i>this attribute should be used either single or coupled with "listName" and "listVersion"</i></p> <p>(XPath KnitClothOrder/KCCObody/KCCOitem/garComInfo/acsPack/acsPackCode/@numberingOrg) [Optional] (a)  - nota: <i>this attribute should be used either single or coupled with "listName" and "listVersion"</i></p> <p>(XPath KnitClothOrder/KCCObody/KCCOitem/garComInfo/garPack/garPackCode/@numberingOrg) [Optional] (a)  - nota: <i>this attribute should be used either single or coupled with "listName" and "listVersion"</i></p> <p>(XPath KnitClothOrder/KCCObody/KCCOitem/garComInfo/note/@numberingOrg) [Optional]  - nota: <i>must be used to specify the organization that created the list of code s used in "noteLabel"</i></p> <p>(XPath KnitClothOrder/terms/allowanceCharge/dtScheme/note/@numberingOrg) [Optional]  - nota: <i>must be used to specify the organization that created the list of code s used in "noteLabel"</i></p> <p>(XPath KnitClothOrder/garComInfo/brand/@numberingOrg) [Optional] (a)  - nota: <i>this attribute should be used either single or coupled with "listName" and "listVersion"</i></p> <p>(XPath KnitClothOrder/garComInfo/season/@numberingOrg) [Optional] (a)  - nota: <i>this attribute should be used either single or coupled with "listName" and "listVersion"</i></p> <p>(XPath KnitClothOrder/garComInfo/garPack/garPackCode/@numberingOrg) [Optional] (a)  - nota: <i>this attribute should be used either single or coupled with "listName" and "listVersion"</i></p> <p>(XPath KnitClothOrder/KCCObody/KCCOitem/apparelProd/garmentPartCode/fabric/@numberingOrg) [Optional]  - nota: <i>this attribute should be used either single or coupled with "listName" and "listVersion"</i></p> <p>(XPath KnitClothOrder/KCCObody/KCCOitem/apparelProd/garmentPartCode/mod/@numberingOrg) [Optional]</p>
--	---



(XPath KnitClothOrder/KCCObody/KCCOitem/apparelProd/garmentPartCode/color/@numberingOrg) [Optional]  
- nota: *this attribute should be used either single or coupled with "listName" and "listVersion"*

(XPath KnitClothOrder/KCCObody/KCCOitem/garComInfo/season/@numberingOrg) [Optional] (a)  
- nota: *this attribute should be used either single or coupled with "listName" and "listVersion"*

(XPath KnitClothOrder/KCCObody/KCCOitem/apparelProd/garmentPartCode/@numberingOrg) [Optional]  
(XPath KnitClothOrder/garComInfo/note/@numberingOrg) [Optional]  
- nota: *must be used to specify the organization that created the list of codes used in "noteLabel"*

(XPath KnitClothOrder/KCCObody/KCCOitem/garComInfo/operationalCode/@numberingOrg) [Optional]  
- nota: *this attribute should be used either single or coupled with "listName" and "listVersion"*

(XPath KnitClothOrder/KCCObody/KCCOitem/garComInfo/brand/@numberingOrg) [Optional] (a)  
- nota: *this attribute should be used either single or coupled with "listName" and "listVersion"*

(XPath KnitClothOrder/KCCObody/KCCOitem/garComInfo/productLine/@numberingOrg) [Optional]  
- nota: *this attribute should be used either single or coupled with "listName" and "listVersion"*

(XPath KnitClothOrder/KCCOheader/subContractor/id/@numberingOrg) [Optional]  
(XPath KnitClothOrder/KCCObody/KCCOitem/endUseGroup/csRange/sizeMatrix/sizeRow/additionalComponentCode/@numberingOrg) [Optional] (a)  
- nota: *this attribute should be used either single or coupled with "listName" and "listVersion"*

(XPath KnitClothOrder/KCCOheader/buyer/additionalIdentifier/@numberingOrg) [Optional] (a)  
- nota: *here the issuer of the identifier must be specified*

(XPath KnitClothOrder/KCCObody/KCCOitem/packages/handlingChar/acsPack/acsPackCode/@numberingOrg) [Optional] (a)  
- nota: *this attribute should be used either single or coupled with "listName" and "listVersion"*

(XPath KnitClothOrder/KCCObody/KCCOitem/packages/packageModelCode/@numberingOrg) [Optional]  
(XPath KnitClothOrder/KCCOheader/note/@numberingOrg) [Optional]  
- nota: *must be used to specify the organization that created the list of codes used in "noteLabel"*

(XPath KnitClothOrder/KCCOheader/thirdParty/id/@numberingOrg) [Optional]  
(XPath KnitClothOrder/KCCObody/KCCOitem/endUseGroup/csRange/sizeMatrix/sizeRow/drop/@numberingOrg) [Optional] (a)  
- nota: *this attribute should be used either single or coupled with "listName" and "listVersion"*

(XPath KnitClothOrder/KCCObody/KCCOitem/endUseGroup/csRange/sizeMatrix/sizeRow/size/@numberingOrg) [Optional] (a)  
- nota: *this attribute should be used either single or coupled with "listName" and "listVersion"*

(XPath KnitClothOrder/KCCOheader/buyer/id/@numberingOrg) [Optional]  
(XPath KnitClothOrder/KCCObody/KCCOitem/endUseGroup/csRange/@numberingOrg) [Optional]  
(XPath KnitClothOrder/KCCObody/KCCOitem/endUseGroup/csRange/color/@numberingOrg) [Optional]  
- nota: *this attribute should be used either single or coupled with "listName" and "listVersion"*

(XPath KnitClothOrder/KCCOheader/refDoc/season/@numberingOrg) [Optional] (a)  
- nota: *this attribute should be used either single or coupled with "listName" and "listVersion"*

(XPath KnitClothOrder/terms/allowanceCharge/dtScheme/legalRef/@numberingOrg) [Optional]

- nota: *this attribute should be used either single or coupled with "listName" and "listVersion"*  
(XPath KnitClothOrder/KCCOheader/refDoc/attachment/  
fileName/@numberingOrg) [Optional]

(XPath KnitClothOrder/KCCObody/KCCOitem/endUseGroup/  
csRange/garmentVariant/variantCode/@numberingOrg) [Optional] (a)

- nota: *this attribute should be used either single or coupled with "listName" and "listVersion"*  
(XPath KnitClothOrder/KCCObody/KCCOitem/endUseGroup/  
csRange/drop/@numberingOrg) [Optional] (a)

- nota: *this attribute should be used either single or coupled with "listName" and "listVersion"*  
(XPath KnitClothOrder/KCCObody/KCCOitem/endUseGroup/  
csRange/garmentVariant/variantType/@numberingOrg) [Optional] (a)

- nota: *this attribute should be used either single or coupled with "listName" and "listVersion"*  
(XPath KnitClothOrder/KCCObody/KCCOitem/packages/  
handlingChar/garPack/garPackCode/@numberingOrg) [Optional] (a)

- nota: *this attribute should be used either single or coupled with "listName" and "listVersion"*  
(XPath KnitClothOrder/KCCObody/KCCOitem/apparelProd/  
garmentPartCode/added/@numberingOrg) [Optional]

- nota: *this attribute should be used either single or coupled with "listName" and "listVersion"*  
(XPath KnitClothOrder/KCCObody/KCCOitem/apparelProd/  
csRange/@numberingOrg) [Optional]

(XPath KnitClothOrder/KCCObody/KCCOitem/apparelProd/dyeN/@numberingOrg) [Optional]

(XPath KnitClothOrder/KCCObody/KCCOitem/apparelProd/  
csRange/garmentVariant/variantType/@numberingOrg) [Optional] (a)

- nota: *this attribute should be used either single or coupled with "listName" and "listVersion"*  
(XPath KnitClothOrder/KCCObody/KCCOitem/apparelProd/  
csRange/color/@numberingOrg) [Optional]

- nota: *this attribute should be used either single or coupled with "listName" and "listVersion"*  
(XPath KnitClothOrder/KCCObody/KCCOitem/apparelProd/lotN/@numberingOrg) [Optional]

(XPath KnitClothOrder/KCCObody/KCCOitem/phase/packages/  
handlingChar/acsPack/acsPackCode/@numberingOrg) [Optional] (a)

- nota: *this attribute should be used either single or coupled with "listName" and "listVersion"*  
(XPath KnitClothOrder/KCCObody/KCCOitem/apparelProd/  
garmentCode/garmentCodeB/added/@numberingOrg) [Optional]

- nota: *this attribute should be used either single or coupled with "listName" and "listVersion"*  
(XPath KnitClothOrder/KCCObody/KCCOitem/endUseGroup/  
csRange/sizeMatrix/sizeRow/itemsList/itemIdentification/serialN/@numberingOrg) [Optional]

- nota: *here the issuer of the serial number must be specified (when different from the Supplier)*  
(XPath KnitClothOrder/KCCObody/KCCOitem/apparelProd/  
garmentCode/garmentCodeA/art/@numberingOrg) [Optional]

- nota: *this attribute should be used either single or coupled with "listName" and "listVersion"*  
(XPath KnitClothOrder/KCCObody/KCCOitem/phase/packages/  
packageModelCode/@numberingOrg) [Optional]

(XPath  
KnitClothOrder/KCCObody/KCCOitem/phase/garConsumptionSet/garConsumption/@numberingOrg) [Optional]

- nota: *to be used for garSizeCode*  
(XPath KnitClothOrder/KCCObody/KCCOitem/apparelProd/  
csRange/sizeMatrix/sizeRow/size/@numberingOrg) [Optional] (a)

- nota: *this attribute should be used either single or coupled with "listName" and "listVersion"*



	<p>(XPath KnitClothOrder/KCCObody/KCCOitem/packages/packageN/@numberingOrg) [Optional]</p> <p>(XPath KnitClothOrder/KCCObody/KCCOitem/phase/garConsumptionSet/dyeN/@numberingOrg) [Optional]</p> <p>(XPath KnitClothOrder/KCCObody/KCCOitem/phase/garConsumptionSet/garConsumption/garSizeCode/@numberingOrg) [Optional] (a)</p> <p>- nota: <i>this attribute should be used either single or coupled with "listName" and "listVersion"</i></p> <p>(XPath KnitClothOrder/KCCObody/KCCOitem/apparelProd/csRange/drop/@numberingOrg) [Optional] (a)</p> <p>- nota: <i>this attribute should be used either single or coupled with "listName" and "listVersion"</i></p> <p>(XPath KnitClothOrder/KCCObody/KCCOitem/apparelProd/csRange/garmentVariant/variantCode/@numberingOrg) [Optional] (a)</p> <p>- nota: <i>this attribute should be used either single or coupled with "listName" and "listVersion"</i></p> <p>(XPath KnitClothOrder/KCCObody/KCCOitem/apparelProd/csRange/sizeMatrix/sizeRow/drop/@numberingOrg) [Optional] (a)</p> <p>- nota: <i>this attribute should be used either single or coupled with "listName" and "listVersion"</i></p> <p>(XPath KnitClothOrder/KCCObody/KCCOitem/apparelProd/csRange/sizeMatrix/sizeRow/additionalComponentCode/@numberingOrg) [Optional] (a)</p> <p>- nota: <i>this attribute should be used either single or coupled with "listName" and "listVersion"</i></p> <p>(XPath KnitClothOrder/KCCObody/KCCOitem/apparelProd/garmentCode/@numberingOrg) [Optional]</p> <p>(XPath KnitClothOrder/KCCObody/KCCOitem/phase/packages/packageN/@numberingOrg) [Optional]</p> <p>(XPath KnitClothOrder/KCCObody/KCCOitem/apparelProd/garmentCode/garmentCodeB/@numberingOrg) [Optional]</p> <p>(XPath KnitClothOrder/KCCObody/KCCOitem/endUseGroup/csRange/sizeMatrix/sizeRow/itemsList/qualityLevel/@numberingOrg) [Optional] (a)</p> <p>- nota: <i>this attribute should be used either single or coupled with "listName" and "listVersion"</i></p> <p>(XPath KnitClothOrder/KCCObody/KCCOitem/packages/handlingChar/note/@numberingOrg) [Optional]</p> <p>- nota: <i>must be used to specify the organization that created the list of codes used in "noteLabel"</i></p> <p>(XPath KnitClothOrder/KCCObody/KCCOitem/phase/packages/EPClist/EPC/@numberingOrg) [Optional]</p> <p>(XPath KnitClothOrder/KCCObody/KCCOitem/phase/note/@numberingOrg) [Optional]</p> <p>- nota: <i>must be used to specify the organization that created the list of codes used in "noteLabel"</i></p> <p>(XPath KnitClothOrder/KCCOheader/refDoc/docID/@numberingOrg) [Optional]</p> <p>- nota: <i>here can be specified whose document numbering is used (e.g.: Client, Supplier, ..)</i></p> <p>(XPath KnitClothOrder/KCCObody/KCCOitem/apparelProd/garmentPartCode/size/@numberingOrg) [Optional] (a)</p> <p>- nota: <i>this attribute should be used either single or coupled with "listName" and "listVersion"</i></p> <p>(XPath KnitClothOrder/KCCObody/KCCOitem/phase/packages/handlingChar/note/@numberingOrg) [Optional]</p> <p>- nota: <i>must be used to specify the organization that created the list of codes used in "noteLabel"</i></p> <p>(XPath KnitClothOrder/KCCObody/KCCOitem/apparelProd/garmentCode/garmentCodeB/drop/@numberingOrg) [Optional] (a)</p> <p>- nota: <i>this attribute should be used either single or coupled with "listName" and "listVersion"</i></p> <p>(XPath KnitClothOrder/KCCObody/KCCOitem/phase/packages/handlingChar/garPack/garPackCode/@numberingOrg) [Optional] (a)</p>
--	---

- nota: *this attribute should be used either single or coupled with "listName" and "listVersion"*  
(XPath KnitClothOrder/KCCObody/KCCOitem/apparelProd/  
garmentCode/garmentCodeB/artGroup/@numberingOrg) [Optional]

- nota: *this attribute should be used either single or coupled with "listName" and "listVersion"*  
(XPath KnitClothOrder/KCCObody/KCCOitem/apparelProd/  
garmentCode/garmentCodeB/size/@numberingOrg) [Optional] (a)

- nota: *this attribute should be used either single or coupled with "listName" and "listVersion"*  
(XPath KnitClothOrder/KCCObody/KCCOitem/apparelProd/  
garmentCode/garmentCodeB/garmentVariant/variantCode/@numberingOrg)  
[Optional] (a)

- nota: *this attribute should be used either single or coupled with "listName" and "listVersion"*  
(XPath KnitClothOrder/KCCObody/KCCOitem/apparelProd/  
garmentCode/garmentCodeB/fabric/@numberingOrg) [Optional]

- nota: *this attribute should be used either single or coupled with "listName" and "listVersion"*  
(XPath KnitClothOrder/KCCObody/KCCOitem/apparelProd/  
garmentCode/garmentCodeB/mod/@numberingOrg) [Optional]

(XPath KnitClothOrder/KCCObody/KCCOitem/apparelProd/  
garmentCode/garmentCodeB/garmentVariant/variantType/@numberingOrg)  
[Optional] (a)

- nota: *this attribute should be used either single or coupled with "listName" and "listVersion"*  
(XPath KnitClothOrder/KCCObody/KCCOitem/apparelProd/  
garmentCode/garmentCodeB/color/@numberingOrg) [Optional]

- nota: *this attribute should be used either single or coupled with "listName" and "listVersion"*  
(XPath KnitClothOrder/KCCObody/KCCOitem/phase/lotDetails/  
csRange/drop/@numberingOrg) [Optional] (a)

- nota: *this attribute should be used either single or coupled with "listName" and "listVersion"*  
(XPath KnitClothOrder/KCCObody/KCCOitem/apparelComponent/  
fabricComponent/texCode/pattern/@numberingOrg) [Optional]

- nota: *this attribute should be used either single or coupled with "listName" and "listVersion"*  
(XPath KnitClothOrder/KCCObody/KCCOitem/garTecSheet/  
garConsumptionSet/dyeN/@numberingOrg) [Optional]

(XPath KnitClothOrder/KCCObody/KCCOitem/garTecSheet/  
garConsumptionSet/lotN/@numberingOrg) [Optional]

(XPath KnitClothOrder/KCCObody/KCCOitem/apparelComponent/  
fabricComponent/texCode/@numberingOrg) [Optional]

(XPath KnitClothOrder/KCCObody/KCCOitem/apparelComponent/  
fabricComponent/texCode/art/@numberingOrg) [Optional]

- nota: *this attribute should be used either single or coupled with "listName" and "listVersion"*  
(XPath KnitClothOrder/KCCObody/KCCOitem/garTecSheet/  
garConsumptionSet/garConsumption/@numberingOrg) [Optional]

- nota: *to be used for garSizeCode*  
(XPath KnitClothOrder/KCCObody/KCCOitem/apparelComponent/  
fabricComponent/texCode/added/@numberingOrg) [Optional]

- nota: *this attribute should be used either single or coupled with "listName" and "listVersion"*  
(XPath KnitClothOrder/KCCObody/KCCOitem/apparelComponent/  
garmentPartComponent/garmentPartCode/size/@numberingOrg) [Optional] (a)

- nota: *this attribute should be used either single or coupled with "listName" and "listVersion"*  
(XPath KnitClothOrder/KCCObody/KCCOitem/phase/lotDetails/  
csRange/garmentVariant/variantCode/@numberingOrg) [Optional] (a)

- nota: *this attribute should be used either single or coupled with "listName" and "listVersion"*

	<p>(XPath KnitClothOrder/KCCObody/KCCOitem/phase/thirdParty/id/@numberingOrg) [Optional]</p> <p>(XPath KnitClothOrder/KCCObody/KCCOitem/garTecSheet/garConsumptionSet/garConsumption/garSizeCode/@numberingOrg) [Optional] (a)</p> <p>- nota: <i>this attribute should be used either single or coupled with "listName" and "listVersion"</i></p> <p>(XPath KnitClothOrder/KCCObody/KCCOitem/apparelComponent/fabricComponent/texCode/color/@numberingOrg) [Optional]</p> <p>- nota: <i>this attribute should be used either single or coupled with "listName" and "listVersion"</i></p> <p>(XPath KnitClothOrder/KCCObody/KCCOitem/phase/garConsumptionSet/acsCode/@numberingOrg) [Optional]</p> <p>(XPath KnitClothOrder/KCCObody/KCCOitem/garTecSheet/garConsumptionSet/garmentCode/garmentCodeB/added/@numberingOrg) [Optional]</p> <p>- nota: <i>this attribute should be used either single or coupled with "listName" and "listVersion"</i></p> <p>(XPath KnitClothOrder/KCCObody/KCCOitem/phase/lotDetails/csRange/sizeMatrix/sizeRow/additionalComponentCode/@numberingOrg) [Optional] (a)</p> <p>- nota: <i>this attribute should be used either single or coupled with "listName" and "listVersion"</i></p> <p>(XPath KnitClothOrder/KCCObody/KCCOitem/garTecSheet/garConsumptionSet/garmentCode/garmentCodeB/size/@numberingOrg) [Optional] (a)</p> <p>- nota: <i>this attribute should be used either single or coupled with "listName" and "listVersion"</i></p> <p>(XPath KnitClothOrder/KCCObody/KCCOitem/phase/garConsumptionSet/acsCode/art/@numberingOrg) [Optional]</p> <p>- nota: <i>this attribute should be used either single or coupled with "listName" and "listVersion"</i></p> <p>(XPath KnitClothOrder/KCCObody/KCCOitem/garTecSheet/garConsumptionSet/garmentCode/garmentCodeB/artGroup/@numberingOrg) [Optional]</p> <p>- nota: <i>this attribute should be used either single or coupled with "listName" and "listVersion"</i></p> <p>(XPath KnitClothOrder/KCCObody/KCCOitem/garTecSheet/garConsumptionSet/garmentCode/garmentCodeA/art/@numberingOrg) [Optional]</p> <p>- nota: <i>this attribute should be used either single or coupled with "listName" and "listVersion"</i></p> <p>(XPath KnitClothOrder/KCCObody/KCCOitem/apparelComponent/yarnComponent/note/@numberingOrg) [Optional]</p> <p>- nota: <i>must be used to specify the organization that created the list of codes used in "noteLabel"</i></p> <p>(XPath KnitClothOrder/KCCObody/KCCOitem/phase/refDoc/season/@numberingOrg) [Optional]</p> <p>- nota: <i>this attribute should be used either single or coupled with "listName" and "listVersion"</i></p> <p>(XPath KnitClothOrder/KCCObody/KCCOitem/apparelComponent/yarnComponent/yarnCode/@numberingOrg) [Optional] [Default= CL]</p> <p>(XPath KnitClothOrder/KCCObody/KCCOitem/appMnfrOperation/refDoc/season/@numberingOrg) [Optional] (a)</p> <p>- nota: <i>this attribute should be used either single or coupled with "listName" and "listVersion"</i></p> <p>(XPath KnitClothOrder/KCCObody/KCCOitem/apparelComponent/garmentPartComponent/dyeN/@numberingOrg) [Optional]</p> <p>(XPath KnitClothOrder/KCCObody/KCCOitem/apparelComponent/garmentPartComponent/lotN/@numberingOrg) [Optional]</p> <p>(XPath KnitClothOrder/KCCObody/KCCOitem/apparelComponent/yarnComponent/refDoc/attachment/fileName/@numberingOrg) [Optional] (a)</p>
--	---

(XPath KnitClothOrder/KCCObody/KCCOitem/apparelComponent/garmentPartComponent/garmentPartCode/mod/@numberingOrg) [Optional]

(XPath KnitClothOrder/KCCObody/KCCOitem/apparelComponent/fabricComponent/refDoc/season/@numberingOrg) [Optional] (a)

- nota: *this attribute should be used either single or coupled with "listName" and "listVersion"*

(XPath KnitClothOrder/KCCObody/KCCOitem/apparelComponent/fabricComponent/refDoc/attachment/fileName/@numberingOrg) [Optional] (a)

)

(XPath KnitClothOrder/KCCObody/KCCOitem/phase/lotDetails/lotN/@numberingOrg) [Optional]

(XPath KnitClothOrder/KCCObody/KCCOitem/apparelComponent/garmentPartComponent/garmentPartCode/color/@numberingOrg) [Optional]

- nota: *this attribute should be used either single or coupled with "listName" and "listVersion"*

(XPath KnitClothOrder/KCCObody/KCCOitem/apparelComponent/garmentPartComponent/garmentPartCode/fabric/@numberingOrg) [Optional]

- nota: *this attribute should be used either single or coupled with "listName" and "listVersion"*

(XPath KnitClothOrder/KCCObody/KCCOitem/phase/phaseCode/@numberingOrg) [Optional] (a)

- nota: *this attribute should be used either single or coupled with "listName" and "listVersion"*

(XPath KnitClothOrder/KCCObody/KCCOitem/appMnfrOperation/note/@numberingOrg) [Optional]

- nota: *must be used to specify the organization that created the list of codes used in "noteLabel"*

(XPath KnitClothOrder/KCCObody/KCCOitem/progress/itemsList/qualityLevel/@numberingOrg) [Optional] (a)

- nota: *this attribute should be used either single or coupled with "listName" and "listVersion"*

(XPath KnitClothOrder/KCCObody/KCCOitem/apparelComponent/fabricComponent/note/@numberingOrg) [Optional]

- nota: *must be used to specify the organization that created the list of codes used in "noteLabel"*

(XPath KnitClothOrder/KCCObody/KCCOitem/apparelComponent/garmentPartComponent/garmentPartCode/@numberingOrg) [Optional]

(XPath KnitClothOrder/KCCObody/KCCOitem/phase/refDoc/attachment/fileName/@numberingOrg) [Optional] (a)

(XPath KnitClothOrder/KCCObody/KCCOitem/progress/itemsList/itemIdentification/serialN/@numberingOrg) [Optional]

- nota: *here the issuer of the serial number must be specified (when different from the Supplier)*

(XPath KnitClothOrder/KCCObody/KCCOitem/apparelComponent/fabricComponent/itemsList/qualityLevel/@numberingOrg) [Optional] (a)

- nota: *this attribute should be used either single or coupled with "listName" and "listVersion"*

(XPath KnitClothOrder/KCCObody/KCCOitem/phase/lotDetails/csRange/color/@numberingOrg) [Optional]

- nota: *this attribute should be used either single or coupled with "listName" and "listVersion"*

(XPath KnitClothOrder/KCCObody/KCCOitem/phase/lotDetails/csRange/sizeMatrix/sizeRow/itemsList/qualityLevel/@numberingOrg) [Optional] (a)

- nota: *this attribute should be used either single or coupled with "listName" and "listVersion"*

(XPath KnitClothOrder/KCCObody/KCCOitem/apparelComponent/yarnComponent/refDoc/docID/@numberingOrg) [Optional]

- nota: *here can be specified whose document numbering is used (e.g.: Client, Supplier, ..)*

(XPath KnitClothOrder/KCCObody/KCCOitem/phase/lotDetails/csRange/garmentVariant/variantType/@numberingOrg) [Optional] (a)

- nota: *this attribute should be used either single or coupled with "listName" and "listVersion"*

(XPath KnitClothOrder/KCCObody/KCCOitem/apparelComponent/fabricComponent/serialN/@numberingOrg) [Optional]  
- nota: here the issuer of the serial number must be specified (when different from the Supplier)

(XPath KnitClothOrder/KCCObody/KCCOitem/progress/qualityLevel/@numberingOrg) [Optional]  
- nota: this attribute should be used either single or coupled with "listName" and "listVersion"

(XPath KnitClothOrder/KCCObody/KCCOitem/apparelComponent/garmentPartComponent/garmentPartCode/added/@numberingOrg) [Optional]  
- nota: this attribute should be used either single or coupled with "listName" and "listVersion"

(XPath KnitClothOrder/KCCObody/KCCOitem/phase/lotDetails/csRange/@numberingOrg) [Optional]

(XPath KnitClothOrder/KCCObody/KCCOitem/apparelComponent/fabricComponent/refDoc/docID/@numberingOrg) [Optional]  
- nota: here can be specified whose document numbering is used (e.g.: Client, Supplier, ..)

(XPath KnitClothOrder/KCCObody/KCCOitem/appMnfrOperation/refDoc/attachment/fileName/@numberingOrg) [Optional] (a)

(XPath KnitClothOrder/KCCObody/KCCOitem/apparelComponent/fabricComponent/itemsList/itemIdentification/serialN/@numberingOrg) [Optional]  
- nota: here the issuer of the serial number must be specified (when different from the Supplier)

(XPath KnitClothOrder/KCCObody/KCCOitem/apparelComponent/yarnComponent/refDoc/season/@numberingOrg) [Optional] (a)  
- nota: this attribute should be used either single or coupled with "listName" and "listVersion"

(XPath KnitClothOrder/KCCObody/KCCOitem/apparelComponent/acsComponent/refDoc/docID/@numberingOrg) [Optional]  
- nota: here can be specified whose document numbering is used (e.g.: Client, Supplier, ..)

(XPath KnitClothOrder/KCCObody/KCCOitem/apparelComponent/acsComponent/refDoc/season/@numberingOrg) [Optional] (a)  
- nota: this attribute should be used either single or coupled with "listName" and "listVersion"

(XPath KnitClothOrder/KCCObody/KCCOitem/garTecSheet/garConsumptionSet/garmentPartCode/added/@numberingOrg) [Optional]  
- nota: this attribute should be used either single or coupled with "listName" and "listVersion"

(XPath KnitClothOrder/KCCObody/KCCOitem/phase/lotDetails/csRange/sizeMatrix/sizeRow/drop/@numberingOrg) [Optional] (a)  
- nota: this attribute should be used either single or coupled with "listName" and "listVersion"

(XPath KnitClothOrder/KCCObody/KCCOitem/garTecSheet/garConsumptionSet/garmentPartCode/fabric/@numberingOrg) [Optional]  
- nota: this attribute should be used either single or coupled with "listName" and "listVersion"

(XPath KnitClothOrder/KCCObody/KCCOitem/garTecSheet/garConsumptionSet/garmentPartCode/color/@numberingOrg) [Optional]  
- nota: this attribute should be used either single or coupled with "listName" and "listVersion"

(XPath KnitClothOrder/KCCObody/KCCOitem/apparelComponent/acsComponent/dyeN/@numberingOrg) [Optional]

(XPath KnitClothOrder/KCCObody/KCCOitem/apparelComponent/acsComponent/acsCode/added/@numberingOrg) [Optional]  
- nota: this attribute should be used either single or coupled with "listName" and "listVersion"

(XPath KnitClothOrder/KCCObody/KCCOitem/apparelComponent/acsComponent/acsCode/color/@numberingOrg) [Optional]  
- nota: this attribute should be used either single or coupled with "listName" and "listVersion"



	<p>(XPath KnitClothOrder/KCCObody/KCCOitem/apparelComponent/acsComponent/refDoc/attachment/fileName/@numberingOrg) [Optional] (a)</p> <p>(XPath KnitClothOrder/KCCObody/KCCOitem/phase/garConsumptionSet/texCode/art/@numberingOrg) [Optional]</p> <p>- nota: <i>this attribute should be used either single or coupled with "listName" and "listVersion"</i></p> <p>(XPath KnitClothOrder/KCCObody/KCCOitem/apparelComponent/acsComponent/lotN/@numberingOrg) [Optional]</p> <p>(XPath KnitClothOrder/KCCObody/KCCOitem/phase/garConsumptionSet/texCode/@numberingOrg) [Optional]</p> <p>(XPath KnitClothOrder/KCCObody/KCCOitem/phase/garConsumptionSet/texCode/added/@numberingOrg) [Optional]</p> <p>- nota: <i>this attribute should be used either single or coupled with "listName" and "listVersion"</i></p> <p>(XPath KnitClothOrder/KCCObody/KCCOitem/garTecSheet/garConsumptionSet/yarnCode/@numberingOrg) [Optional] [Default= CL]</p> <p>(XPath KnitClothOrder/KCCObody/KCCOitem/garTecSheet/garConsumptionSet/yarnCode/art/@numberingOrg) [Optional]</p> <p>- nota: <i>this attribute should be used either single or coupled with "listName" and "listVersion"</i></p> <p>(XPath KnitClothOrder/KCCObody/KCCOitem/garTecSheet/garConsumptionSet/texCode/color/@numberingOrg) [Optional]</p> <p>- nota: <i>this attribute should be used either single or coupled with "listName" and "listVersion"</i></p> <p>(XPath KnitClothOrder/KCCObody/KCCOitem/garTecSheet/garConsumptionSet/texCode/added/@numberingOrg) [Optional]</p> <p>- nota: <i>this attribute should be used either single or coupled with "listName" and "listVersion"</i></p> <p>(XPath KnitClothOrder/KCCObody/KCCOitem/phase/lotDetails/csRange/sizeMatrix/sizeRow/size/@numberingOrg) [Optional] (a)</p> <p>- nota: <i>this attribute should be used either single or coupled with "listName" and "listVersion"</i></p> <p>(XPath KnitClothOrder/KCCObody/KCCOitem/garTecSheet/garConsumptionSet/yarnCode/color/@numberingOrg) [Optional]</p> <p>- nota: <i>this attribute should be used either single or coupled with "listName" and "listVersion"</i></p> <p>(XPath KnitClothOrder/KCCObody/KCCOitem/garTecSheet/garConsumptionSet/garmentPartCode/mod/@numberingOrg) [Optional]</p> <p>(XPath KnitClothOrder/KCCObody/KCCOitem/apparelComponent/yarnComponent/dyeN/@numberingOrg) [Optional]</p> <p>(XPath KnitClothOrder/KCCObody/KCCOitem/phase/garConsumptionSet/texCode/pattern/@numberingOrg) [Optional]</p> <p>- nota: <i>this attribute should be used either single or coupled with "listName" and "listVersion"</i></p> <p>(XPath KnitClothOrder/KCCObody/KCCOitem/garTecSheet/garConsumptionSet/yarnCode/added/@numberingOrg) [Optional]</p> <p>- nota: <i>this attribute should be used either single or coupled with "listName" and "listVersion"</i></p> <p>(XPath KnitClothOrder/KCCObody/KCCOitem/phase/garConsumptionSet/texCode/color/@numberingOrg) [Optional]</p> <p>- nota: <i>this attribute should be used either single or coupled with "listName" and "listVersion"</i></p> <p>(XPath KnitClothOrder/KCCObody/KCCOitem/garTecSheet/garConsumptionSet/garmentPartCode/@numberingOrg) [Optional]</p> <p>(XPath KnitClothOrder/KCCObody/KCCOitem/garTecSheet/garConsumptionSet/garmentPartCode/size/@numberingOrg) [Optional] (a)</p> <p>- nota: <i>this attribute should be used either single or coupled with "listName" and "listVersion"</i></p> <p>(XPath KnitClothOrder/KCCObody/KCCOitem/apparelComponent/acsComponent/note/@numberingOrg) [Optional]</p>
--	--

- nota: *must be used to specify the organization that created the list of code s used in "noteLabel"*  
(XPath KnitClothOrder/KCCObody/KCCOitem/garTecSheet/  
garConsumptionSet/garmentCode/garmentCodeB/garmentVariant/variantTy  
pe/@numberingOrg) [Optional] (a)

- nota: *this attribute should be used either single or coupled with "listName"  
and "listVersion"*  
(XPath KnitClothOrder/KCCObody/KCCOitem/apparelComponent/  
garmentPartComponent/refDoc/attachment/fileName/@numberingOrg) [Opti  
onal] (a)  
(XPath KnitClothOrder/KCCObody/KCCOitem/apparelComponent/  
garmentPartComponent/note/@numberingOrg) [Optional]

- nota: *must be used to specify the organization that created the list of code s used in "noteLabel"*  
(XPath KnitClothOrder/KCCObody/KCCOitem/garTecSheet/  
garConsumptionSet/garmentCode/garmentCodeB/color/@numberingOrg) [O  
ptional]

- nota: *this attribute should be used either single or coupled with "listName"  
and "listVersion"*  
(XPath KnitClothOrder/KCCObody/KCCOitem/apparelComponent/  
yarnComponent/yarnCode/color/@numberingOrg) [Optional]

- nota: *this attribute should be used either single or coupled with "listName"  
and "listVersion"*  
(XPath  
KnitClothOrder/KCCObody/KCCOitem/phase/garConsumptionSet/acsCode/c  
olor/@numberingOrg) [Optional]

- nota: *this attribute should be used either single or coupled with "listName"  
and "listVersion"*  
(XPath KnitClothOrder/KCCObody/KCCOitem/garTecSheet/  
garConsumptionSet/garmentCode/garmentCodeB/drop/@numberingOrg) [O  
ptional] (a)

- nota: *this attribute should be used either single or coupled with "listName"  
and "listVersion"*  
(XPath KnitClothOrder/KCCObody/KCCOitem/apparelComponent/  
garmentPartComponent/refDoc/docID/@numberingOrg) [Optional]

- nota: *here can be specified whose document numbering is used (e.g.: Clie  
nt, Supplier, ..)*  
(XPath KnitClothOrder/KCCObody/KCCOitem/appMnfrOperation/  
refDoc/docID/@numberingOrg) [Optional]

- nota: *here can be specified whose document numbering is used (e.g.: Clie  
nt, Supplier, ..)*  
(XPath KnitClothOrder/KCCObody/KCCOitem/apparelComponent/  
yarnComponent/yarnCode/art/@numberingOrg) [Optional]

- nota: *this attribute should be used either single or coupled with "listName"  
and "listVersion"*  
(XPath KnitClothOrder/KCCObody/KCCOitem/apparelComponent/  
garmentPartComponent/refDoc/season/@numberingOrg) [Optional] (a)

- nota: *this attribute should be used either single or coupled with "listName"  
and "listVersion"*  
(XPath KnitClothOrder/KCCObody/KCCOitem/garTecSheet/  
garConsumptionSet/garmentCode/garmentCodeB/garmentVariant/variantCo  
de/@numberingOrg) [Optional] (a)

- nota: *this attribute should be used either single or coupled with "listName"  
and "listVersion"*  
(XPath  
KnitClothOrder/KCCObody/KCCOitem/phase/garConsumptionSet/acsCode/  
pattern/@numberingOrg) [Optional]

- nota: *this attribute should be used either single or coupled with "listName"  
and "listVersion"*  
(XPath KnitClothOrder/KCCObody/KCCOitem/phase/refDoc/  
docID/@numberingOrg) [Optional]

- nota: *here can be specified whose document numbering is used (e.g.: Clie  
nt, Supplier, ..)*  
(XPath KnitClothOrder/KCCObody/KCCOitem/apparelComponent/  
acsComponent/acsCode/pattern/@numberingOrg) [Optional]



	<p>- nota: <i>this attribute should be used either single or coupled with "listName" and "listVersion"</i></p> <p>(XPath KnitClothOrder/KCCObody/KCCOitem/apparelComponent/yarnComponent/lotN/@numberingOrg) [Optional]</p> <p>(XPath KnitClothOrder/KCCObody/KCCOitem/garTecSheet/garConsumptionSet/garmentCode/garmentCodeB/@numberingOrg) [Optional]</p> <p>(XPath KnitClothOrder/KCCObody/KCCOitem/phase/lotDetails/csRange/sizeMatrix/sizeRow/itemsList/itemIdentification/serialN/@numberingOrg) [Optional]</p> <p>- nota: <i>here the issuer of the serial number must be specified (when different from the Supplier)</i></p> <p>(XPath KnitClothOrder/KCCObody/KCCOitem/apparelComponent/acsComponent/acsCode/art/@numberingOrg) [Optional]</p> <p>- nota: <i>this attribute should be used either single or coupled with "listName" and "listVersion"</i></p> <p>(XPath KnitClothOrder/KCCObody/KCCOitem/phase/garConsumptionSet/acsCode/added/@numberingOrg) [Optional]</p> <p>- nota: <i>this attribute should be used either single or coupled with "listName" and "listVersion"</i></p> <p>(XPath KnitClothOrder/KCCObody/KCCOitem/garTecSheet/garConsumptionSet/garmentCode/garmentCodeB/fabric/@numberingOrg) [Optional]</p> <p>- nota: <i>this attribute should be used either single or coupled with "listName" and "listVersion"</i></p> <p>(XPath KnitClothOrder/KCCObody/KCCOitem/apparelComponent/yarnComponent/yarnCode/added/@numberingOrg) [Optional]</p> <p>- nota: <i>this attribute should be used either single or coupled with "listName" and "listVersion"</i></p> <p>(XPath KnitClothOrder/KCCObody/KCCOitem/garTecSheet/garConsumptionSet/garmentCode/garmentCodeB/mod/@numberingOrg) [Optional]</p> <p>(XPath KnitClothOrder/KCCObody/KCCOitem/apparelComponent/acsComponent/acsCode/@numberingOrg) [Optional]</p> <p>(XPath KnitClothOrder/KCCObody/KCCOitem/garTecSheet/garConsumptionSet/garmentCode/@numberingOrg) [Optional]</p>
operationalCode	<p>operational code: it is the code of a project, an event, an initiative, a sales channel, a management type (eg CITES), ... the document, or product, is connected with.</p> <p>- base type: string,</p> <p>(XPath KnitClothOrder/KCCObody/KCCOitem/garComInfo/operationalCode) 0-19 (N)</p> <p>(XPath KnitClothOrder/garComInfo/operationalCode) 0-19 (N)</p>
package	<p>code specifying the type of transport package</p> <p>- base type: string, cod. table: T11</p> <p><a href="http://www.ebiz.enea.it/moda-ml/repository/codelist/v2018-1/gc_T11.xml">http://www.ebiz.enea.it/moda-ml/repository/codelist/v2018-1/gc_T11.xml</a></p> <p>(XPath KnitClothOrder/KCCObody/KCCOitem/phase/packages/package) 1-1</p> <p>(XPath KnitClothOrder/KCCObody/KCCOitem/packages/package) 1-1</p>
@packageContainerN	<p>reference usable to indicate the outer package containing this package</p> <p>- base type: string, max length: 40,</p> <p>(XPath KnitClothOrder/KCCObody/KCCOitem/packages/packageN/@packageContainerN) [Optional]</p> <p>(XPath KnitClothOrder/KCCObody/KCCOitem/phase/packages/packageN/@packageContainerN) [Optional]</p>
@packageLevel	<p>level used to indicate the hierarchical structure of the packages (from outer to inner levels)</p> <p>- base type: positiveInteger, min inclusive: 1, max inclusive: 9,</p> <p>(XPath KnitClothOrder/KCCObody/KCCOitem/packages/@packageLevel) [Optional]</p> <p>- nota: <i>number fixing the level of the package in the transport structure (from inner to outer). Must either be used for all package types or not be used</i></p>

	<p>(XPath KnitClothOrder/KCCObody/KCCOitem/phase/packages/@packageLevel) [Optional]</p> <p>- nota: <i>number fixing the level of the package in the transport structure (from inner to outer). Must either be used for all package types or not be used</i></p>
packageModelCode	<p>a code (eg a barcode) identifying the type of packaging</p> <p>- base type: string, (XPath KnitClothOrder/KCCObody/KCCOitem/packages/packageModelCode) 0-1 (N)</p> <p>(XPath KnitClothOrder/KCCObody/KCCOitem/phase/packages/packageModelCode) 0-1 (N)</p>
packageN	<p>serial number used to identify a transport package</p> <p>- base type: string, max length: 40, (XPath KnitClothOrder/KCCObody/KCCOitem/phase/packages/packageN) 0-unbounded (U)</p> <p>- note: <i>here the serial no.s of the packages can be identified</i> (XPath KnitClothOrder/KCCObody/KCCOitem/packages/packageN) 0-unbounded (U)</p> <p>- note: <i>here the serial no.s of the packages can be identified</i></p>
packageQty	<p>quantity of the specified transport packages</p> <p>- base type: positiveInteger, (XPath KnitClothOrder/KCCObody/KCCOitem/packages/packageQty) 0-1</p> <p>- note: <i>total for the type of package</i> (XPath KnitClothOrder/KCCObody/KCCOitem/phase/packages/packageQty) 0-1</p> <p>- note: <i>total for the type of package</i></p>
packageText	<p>denomination of the type of transport package (text)</p> <p>- base type: string, max length: 80, (XPath KnitClothOrder/KCCObody/KCCOitem/phase/packages/packageText) 1-1 (U)</p> <p>(XPath KnitClothOrder/KCCObody/KCCOitem/packages/packageText) 1-1 (U)</p>
@part	<p>percent fraction of a total payment</p> <p>- base type: decimal, min inclusive: 1, max inclusive: 99, fraction digits: 2, (XPath KnitClothOrder/terms/insPayment/@part) [Required]</p> <p>- nota: <i>here the % value of each installment must be indicated</i></p>
pattern	<p>pattern/design number of the product, when not included in the article code</p> <p>- base type: string, max length: 15, (XPath KnitClothOrder/KCCObody/KCCOitem/phase/garConsumptionSet/texCode/pattern) 0-1</p> <p>(XPath KnitClothOrder/KCCObody/KCCOitem/apparelComponent/fabricComponent/texCode/pattern) 0-1</p> <p>(XPath KnitClothOrder/KCCObody/KCCOitem/phase/garConsumptionSet/acsCode/pattern) 0-1</p> <p>(XPath KnitClothOrder/KCCObody/KCCOitem/apparelComponent/acsComponent/acsCode/pattern) 0-1</p> <p>(XPath KnitClothOrder/KCCObody/KCCOitem/garTecSheet/garConsumptionSet/texCode/pattern) 0-1</p> <p>(XPath KnitClothOrder/KCCObody/KCCOitem/garTecSheet/garConsumptionSet/acsCode/pattern) 0-1</p>
payMode	<p>way or means of payment</p> <p>- base type: string, cod. table: T2 <a href="http://www.ebiz.enea.it/moda-ml/repository/codelist/v2018-1/gc_T2.xml">http://www.ebiz.enea.it/moda-ml/repository/codelist/v2018-1/gc_T2.xml</a></p> <p>(XPath KnitClothOrder/terms/insPayment/payMode) 0-1</p> <p>(XPath KnitClothOrder/terms/payment/payMode) 0-1</p>
payTerm	<p>code specifying the terms or time by which the payment must be done</p> <p>- base type: string, cod. table: T1 <a href="http://www.ebiz.enea.it/moda-ml/repository/codelist/v2018-1/gc_T1.xml">http://www.ebiz.enea.it/moda-ml/repository/codelist/v2018-1/gc_T1.xml</a></p> <p>(XPath KnitClothOrder/terms/payment/payTerm) 1-1</p> <p>(XPath KnitClothOrder/terms/insPayment/payTerm) 1-1</p>

payTermText	free text specifying the terms by which the payment must be done (time/mode or means) - base type: string, max length: 250, (XPath KnitClothOrder/terms/insPayment/payTermText) 1-1 (U) (XPath KnitClothOrder/terms/payment/payTermText) 1-1 (U)
pcQty	percent quantity of a raw material or of a specified component in a fabric or in a yarn - base type: decimal, min inclusive: 0, max inclusive: 100, fraction digits: 2, (XPath KnitClothOrder/KCCObody/KCCOitem/apparelComponent/yarnComponent/pcQty) 0-1 - note: <i>percentage of the component in the end product</i>
percCompos	fiber rate in the product composition - base type: decimal, min inclusive: 0, max inclusive: 100, fraction digits: 2, (XPath KnitClothOrder/KCCObody/KCCOitem/garTecSheet/fabricCompos/percCompos) 1-9
person	name of the contact person within a Party - base type: string, max length: 40, (XPath KnitClothOrder/KCCOheader/subContractor/person) 0-1 (XPath KnitClothOrder/KCCObody/KCCOitem/phase/thirdParty/person) 0-1 (XPath KnitClothOrder/KCCOheader/buyer/person) 0-1 (XPath KnitClothOrder/KCCOheader/thirdParty/person) 0-1 (XPath KnitClothOrder/KCCObody/KCCOitem/thirdParty/person) 0-1
phaseCode	Code that identifies a production phase of a fashion product. - base type: string, (XPath KnitClothOrder/KCCObody/KCCOitem/phase/phaseCode) 1-1 (N)
@phone	phone number of the contact person within a Party - base type: string, max length: 35, (XPath KnitClothOrder/KCCOheader/buyer/person/@phone) [Optional] (XPath KnitClothOrder/KCCObody/KCCOitem/phase/thirdParty/person/@phone) [Optional] (XPath KnitClothOrder/KCCOheader/subContractor/person/@phone) [Optional] (XPath KnitClothOrder/KCCObody/KCCOitem/thirdParty/person/@phone) [Optional] (XPath KnitClothOrder/KCCOheader/thirdParty/person/@phone) [Optional]
piecelnnWrap1	code specifying the type of inner wrapping/packing used for the fabric piece - base type: string, cod. table: T4 <a href="http://www.ebiz.enea.it/moda-ml/repository/codelist/v2018-1/gc_T4.xml">http://www.ebiz.enea.it/moda-ml/repository/codelist/v2018-1/gc_T4.xml</a> (XPath KnitClothOrder/garComInfo/piecePack/piecelnnWrap1) 1-1 (XPath KnitClothOrder/KCCObody/KCCOitem/garComInfo/piecePack/piecelnnWrap1) 1-1 (XPath KnitClothOrder/KCCObody/KCCOitem/phase/packages/handlingChar/piecePack/piecelnnWrap1) 1-1 (XPath KnitClothOrder/KCCObody/KCCOitem/packages/handlingChar/piecePack/piecelnnWrap1) 1-1
piecelnnWrap2	code sub-specifying the type of inner wrapping/packing used for the fabric piece - base type: string, cod. table: T5 <a href="http://www.ebiz.enea.it/moda-ml/repository/codelist/v2018-1/gc_T5.xml">http://www.ebiz.enea.it/moda-ml/repository/codelist/v2018-1/gc_T5.xml</a> (XPath KnitClothOrder/KCCObody/KCCOitem/garComInfo/piecePack/piecelnnWrap2) 0-1 (XPath KnitClothOrder/KCCObody/KCCOitem/packages/handlingChar/piecePack/piecelnnWrap2) 0-1 (XPath KnitClothOrder/garComInfo/piecePack/piecelnnWrap2) 0-1 (XPath KnitClothOrder/KCCObody/KCCOitem/phase/packages/handlingChar/piecePack/piecelnnWrap2) 0-1
pieceOutWrap	code specifying the type of outer wrapping or packing used for the fabric piece - base type: string, cod. table: T6 <a href="http://www.ebiz.enea.it/moda-ml/repository/codelist/v2018-1/gc_T6.xml">http://www.ebiz.enea.it/moda-ml/repository/codelist/v2018-1/gc_T6.xml</a>

	<p>(XPath KnitClothOrder/KCCObody/KCCOitem/phase/packages/handlingChar/piecePack/pieceOutWrap) 0-1</p> <p>(XPath KnitClothOrder/garComInfo/piecePack/pieceOutWrap) 0-1</p> <p>(XPath KnitClothOrder/KCCObody/KCCOitem/garComInfo/piecePack/pieceOutWrap) 0-1</p> <p>(XPath KnitClothOrder/KCCObody/KCCOitem/packages/handlingChar/piecePack/pieceOutWrap) 0-1</p>
piecePackText	<p>free text specifying the type of wrapping or packing used for the fabric piece</p> <p>- base type: string, max length: 250,</p> <p>(XPath KnitClothOrder/KCCObody/KCCOitem/garComInfo/piecePack/piecePackText) 1-1 (U)</p> <p>(XPath KnitClothOrder/KCCObody/KCCOitem/phase/packages/handlingChar/piecePack/piecePackText) 1-1 (U)</p> <p>(XPath KnitClothOrder/KCCObody/KCCOitem/packages/handlingChar/piecePack/piecePackText) 1-1 (U)</p> <p>(XPath KnitClothOrder/garComInfo/piecePack/piecePackText) 1-1 (U)</p>
postCode	<p>code defining the postal zone</p> <p>- base type: string, max length: 10,</p> <p>(XPath KnitClothOrder/KCCOheader/subContractor/postCode) 0-1</p> <p>(XPath KnitClothOrder/KCCOheader/thirdParty/postCode) 0-1</p> <p>(XPath KnitClothOrder/KCCObody/KCCOitem/thirdParty/postCode) 0-1</p> <p>(XPath KnitClothOrder/KCCObody/KCCOitem/phase/thirdParty/postCode) 0-1</p> <p>(XPath KnitClothOrder/KCCOheader/buyer/postCode) 0-1</p>
price	<p>unit price of the article, object or service specified</p> <p>- base type: decimal, min inclusive: 0, fraction digits: 4,</p> <p>(XPath KnitClothOrder/KCCObody/KCCOitem/phase/price) 0-1 (AU)</p> <p>(XPath KnitClothOrder/KCCObody/KCCOitem/price) 0-1 (AU)</p>
@priceQualifier	<p>type of price with reference to discount and taxes</p> <p>- base type: string, cod. table: NT20</p> <p><a href="http://www.ebiz.enea.it/moda-ml/repository/codelist/v2018-1/gc_NT20.xml">http://www.ebiz.enea.it/moda-ml/repository/codelist/v2018-1/gc_NT20.xml</a></p> <p>(XPath KnitClothOrder/KCCObody/KCCOitem/price/@priceQualifier) [Optional] [Default= NET]</p> <p>(XPath KnitClothOrder/KCCObody/KCCOitem/phase/price/@priceQualifier) [Optional] [Default= NET]</p>
priority	<p>the priority of this row.</p> <p>- base type: string,</p> <p>(XPath KnitClothOrder/KCCObody/KCCOitem/priority) 0-1 (N)</p>
@productLevel	<p>level of the product (end or intermediate) yielded by an operation in a work cycle</p> <p>- base type: string, cod. table: NT22</p> <p><a href="http://www.ebiz.enea.it/moda-ml/repository/codelist/v2018-1/gc_NT22.xml">http://www.ebiz.enea.it/moda-ml/repository/codelist/v2018-1/gc_NT22.xml</a></p> <p>(XPath KnitClothOrder/KCCObody/KCCOitem/@productLevel) [Optional] [Default= END]</p> <p>- nota: <i>the qualifier "intermediate" must be used when the product is also a component in an other line of the same Commission Order</i></p>
productLine	<p>the product line name of a fashion product.</p> <p>- base type: string,</p> <p>(XPath KnitClothOrder/KCCObody/KCCOitem/garComInfo/productLine) 0-1 (N)</p> <p>(XPath KnitClothOrder/garComInfo/productLine) 0-1 (N)</p>
@progr	<p>progressive number in the sequence</p> <p>- base type: positiveInteger, min inclusive: 1,</p> <p>(XPath KnitClothOrder/terms/transInfo/@progr) [Optional] (N)</p> <p>- nota: <i>Indicates the position of the leg in a sequence of transport legs. If it is declared it must be in all the transInfo elements.</i></p> <p>(XPath KnitClothOrder/KCCObody/KCCOitem/phase/@progr) [Required] (Na)</p> <p>(XPath KnitClothOrder/KCCObody/KCCOitem/packages/fillingCriterion/@progr) [Optional] (N)</p> <p>(XPath KnitClothOrder/KCCObody/KCCOitem/phase/packages/fillingCriterion/@progr) [Optional] (N)</p>

project	<p>code used to assign the items ordered (fabric pieces, accessories, garments ...) to a specific project of the Client</p> <p>- base type: string, max length: 40,  (XPath KnitClothOrder/garComInfo/project) 0-1 (U)  (XPath KnitClothOrder/KCCObody/KCCOitem/garComInfo/project) 0-1 (U)</p>
qty	<p>net quantity of the article or object correlated, qualified by the function of the document (ordering, delivering, ..) and by the context</p> <p>- base type: decimal, min inclusive: 0, fraction digits: 2,  (XPath KnitClothOrder/KCCObody/KCCOitem/apparelComponent/fabricComponent/qty) 1-3</p> <p>- note: <i>quantity to be consumed in the transformation. This element can have more instances only if the units of measure are different</i>  (XPath KnitClothOrder/KCCObody/KCCOitem/endUseGroup/csRange/sizeMatrix/sizeRow/qty) 0-1  (XPath KnitClothOrder/KCCObody/KCCOitem/apparelComponent/yarnComponent/qty) 1-2</p> <hr/> <p><b>AAAA-WARNING! - text not AVAILABLE n. 245 - In=en</b>  - note: <i>quantity to be consumed in the manufacturing operation</i>  (XPath KnitClothOrder/KCCObody/KCCOitem/apparelProd/qty) 1-2</p> <hr/> <p><b>AAAA-WARNING! - text not AVAILABLE n. 245 - In=en</b>  (XPath KnitClothOrder/KCCObody/KCCOitem/progress/qty) 1-2 (p)</p> <hr/> <p><b>AAAA-WARNING! - text not AVAILABLE n. 245 - In=en</b>  (XPath KnitClothOrder/KCCObody/KCCOitem/garTecSheet/garConsumptionSet/garConsumption/qty) 1-1</p> <p>- note: <i>here is the provisional consumption</i>  (XPath KnitClothOrder/KCCObody/KCCOitem/phase/garConsumptionSet/garConsumption/qty) 1-1</p> <p>- note: <i>here is the provisional consumption</i>  (XPath KnitClothOrder/KCCObody/KCCOitem/phase/qty) 0-2</p> <hr/> <p><b>AAAA-WARNING! - text not AVAILABLE n. 245 - In=en</b>  - note: <i>Total quantity produced by this phase.</i>  (XPath KnitClothOrder/KCCObody/KCCOitem/endUseGroup/qty) 0-1  (XPath KnitClothOrder/KCCObody/KCCOitem/apparelProd/csRange/sizeMatrix/sizeRow/qty) 0-1  (XPath KnitClothOrder/KCCObody/KCCOitem/apparelComponent/garmentPartComponent/qty) 1-2</p> <hr/> <p><b>AAAA-WARNING! - text not AVAILABLE n. 245 - In=en</b>  (XPath KnitClothOrder/KCCObody/KCCOitem/phase/lotDetails/csRange/sizeMatrix/sizeRow/qty) 0-1  (XPath KnitClothOrder/KCCObody/KCCOitem/phase/lotDetails/qty) 0-1  (XPath KnitClothOrder/KCCObody/KCCOitem/apparelComponent/acsComponent/qty) 1-2</p> <hr/> <p><b>AAAA-WARNING! - text not AVAILABLE n. 245 - In=en</b></p>
qtyVariance	<p>difference between two quantities qualified by the context (e.g.: delivered vs . ordered; received vs. despatched etc..)</p> <p>- base type: decimal, fraction digits: 2,  (XPath KnitClothOrder/KCCObody/KCCOitem/phase/garConsumptionSet/garConsumption/qtyVariance) 0-1</p> <p>- note: <i>here is the difference between provisional and effective consumption</i>  (XPath KnitClothOrder/KCCObody/KCCOitem/garTecSheet/garConsumptionSet/garConsumption/qtyVariance) 0-1</p> <p>- note: <i>here is the difference between provisional and effective consumption</i></p>
qualityLevel	<p>the product quality level (first choice, second choice,...).</p> <p>- base type: string,  (XPath KnitClothOrder/KCCObody/KCCOitem/progress/itemsList/qualityLevel) 0-1 (N)  (XPath KnitClothOrder/KCCObody/KCCOitem/endUseGroup/csRange/sizeMatrix/sizeRow/itemsList/qualityLevel) 0-1 (N)</p>

	<p>(XPath KnitClothOrder/KCCObody/KCCOitem/apparelProd/csRange/sizeMatrix/sizeRow/itemsList/qualityLevel) 0-1 (N)</p> <p>(XPath KnitClothOrder/KCCObody/KCCOitem/apparelComponent/fabricComponent/itemsList/qualityLevel) 0-1 (N)</p> <p>(XPath KnitClothOrder/KCCObody/KCCOitem/phase/lotDetails/csRange/sizeMatrix/sizeRow/itemsList/qualityLevel) 0-1 (N)</p> <p>(XPath KnitClothOrder/KCCObody/KCCOitem/progress/qualityLevel) 0-1 (N)</p>
@reelMat	<p>type of material of which a package for yarn is made</p> <p>- base type: string, cod. table: T30</p> <p><a href="http://www.ebiz.enea.it/moda-ml/repository/codelist/v2018-1/gc_T30.xml">http://www.ebiz.enea.it/moda-ml/repository/codelist/v2018-1/gc_T30.xml</a></p> <p>(XPath KnitClothOrder/KCCObody/KCCOitem/phase/packages/handlingChar/yarnPack/yarnReel/@reelMat) [Optional]</p> <p>(XPath KnitClothOrder/KCCObody/KCCOitem/packages/handlingChar/yarnPack/yarnReel/@reelMat) [Optional]</p> <p>(XPath KnitClothOrder/garComInfo/yarnPack/yarnReel/@reelMat) [Optional]</p> <p>(XPath KnitClothOrder/KCCObody/KCCOitem/garComInfo/yarnPack/yarnReel/@reelMat) [Optional]</p>
@reelType	<p>type of package used for a yarn product</p> <p>- base type: string, cod. table: T29</p> <p><a href="http://www.ebiz.enea.it/moda-ml/repository/codelist/v2018-1/gc_T29.xml">http://www.ebiz.enea.it/moda-ml/repository/codelist/v2018-1/gc_T29.xml</a></p> <p>(XPath KnitClothOrder/garComInfo/yarnPack/yarnReel/@reelType) [Required]</p> <p>(XPath KnitClothOrder/KCCObody/KCCOitem/packages/handlingChar/yarnPack/yarnReel/@reelType) [Required]</p> <p>(XPath KnitClothOrder/KCCObody/KCCOitem/phase/packages/handlingChar/yarnPack/yarnReel/@reelType) [Required]</p> <p>(XPath KnitClothOrder/KCCObody/KCCOitem/garComInfo/yarnPack/yarnReel/@reelType) [Required]</p>
@role	<p>Third Party role qualifier</p> <p>- base type: string, cod. table: NT2</p> <p><a href="http://www.ebiz.enea.it/moda-ml/repository/codelist/v2018-1/gc_NT2.xml">http://www.ebiz.enea.it/moda-ml/repository/codelist/v2018-1/gc_NT2.xml</a></p> <p>(XPath KnitClothOrder/KCCOheader/thirdParty/@role) [Required]</p> <p>(XPath KnitClothOrder/KCCObody/KCCOitem/thirdParty/@role) [Required]</p> <p>(XPath KnitClothOrder/KCCObody/KCCOitem/phase/thirdParty/@role) [Required]</p>
season	<p>sale season; defined as: season (1 crt) + year (4 crt) - season: S/S=1 A/W=2 Spring=3 Summer=4 Autumn=5 Winter=6: for more than four seasons use alphabetic sequence: 1st season=A 2nd season=B etc.etc.</p> <p>- base type: string, max length: 15,</p> <p>(XPath KnitClothOrder/KCCObody/KCCOitem/apparelComponent/garmentPartComponent/refDoc/season) 0-1 (A)</p> <p>- note: <i>here indicates the season to which the referenced document belongs</i></p> <p>(XPath KnitClothOrder/KCCObody/KCCOitem/garTecSheet/refDoc/season) 0-1 (A)</p> <p>- note: <i>here indicates the season to which the referenced document belongs</i></p> <p>(XPath KnitClothOrder/KCCObody/KCCOitem/appMnfrOperation/refDoc/season) 0-1 (A)</p> <p>- note: <i>here indicates the season to which the referenced document belongs</i></p> <p>(XPath KnitClothOrder/KCCOheader/refDoc/season) 0-1 (A)</p> <p>- note: <i>here indicates the season to which the referenced document belongs</i></p> <p>(XPath KnitClothOrder/KCCObody/KCCOitem/apparelComponent/fabricComponent/refDoc/season) 0-1 (A)</p> <p>- note: <i>here indicates the season to which the referenced document belongs</i></p> <p>(XPath KnitClothOrder/garComInfo/season) 0-1 (A)</p> <p>- note: <i>Preferably do not use this element here if season is declared in the header.</i></p> <p>(XPath KnitClothOrder/KCCObody/KCCOitem/apparelComponent/acsComponent/refDoc/season) 0-1 (A)</p> <p>- note: <i>here indicates the season to which the referenced document belongs</i></p> <p>(XPath KnitClothOrder/KCCObody/KCCOitem/apparelComponent/yarnComponent/refDoc/season) 0-1 (A)</p> <p>- note: <i>here indicates the season to which the referenced document belongs</i></p> <p>(XPath KnitClothOrder/KCCOheader/season) 0-1 (A)</p> <p>(XPath KnitClothOrder/KCCObody/KCCOitem/garComInfo/season) 0-1 (A)</p>



	<p>- note: <i>Preferably do not use this element here if season is declared in the header.</i>  (XPath KnitClothOrder/KCCObody/KCCOitem/phase/refDoc/season) 0-1 (A)</p> <p>- note: <i>here indicates the season to which the referenced document belongs</i></p>
@sender	<p>qualifier that specifies the Party issuing of the document</p> <p>- base type: boolean,  (XPath KnitClothOrder/KCCObody/KCCOitem/phase/thirdParty/@sender) [Optional] (a*)</p> <p>- nota: <i>This attribute is mandatory when the STYLESHEET must be used</i>  (XPath KnitClothOrder/KCCOheader/buyer/@sender) [Optional] (a*)</p> <p>- nota: <i>This attribute is mandatory when the STYLESHEET must be used</i>  (XPath KnitClothOrder/KCCOheader/subContractor/@sender) [Optional] (a*)</p> <p>- nota: <i>This attribute is mandatory when the STYLESHEET must be used</i>  (XPath KnitClothOrder/KCCOheader/thirdParty/@sender) [Optional] (a*)</p> <p>- nota: <i>This attribute is mandatory when the STYLESHEET must be used</i>  (XPath KnitClothOrder/KCCObody/KCCOitem/thirdParty/@sender) [Optional] (a*)</p> <p>- nota: <i>This attribute is mandatory when the STYLESHEET must be used</i></p>
serialN	<p>serial number used for the identification of a physical unit</p> <p>- base type: string, max length: 250,  (XPath KnitClothOrder/KCCObody/KCCOitem/apparelProd/csRange/sizeMatrix/sizeRow/itemsList/itemIdentification/serialN) 1-9 (AU)</p> <hr/> <p><b>AAAA-WARNING! - text not AVAILABLE n. 245 - In=en</b>  - note: <i>multiple values of serialN are allowed for different representations of the serial identifier of the same product unit. Instances of serialN must differ at least for one value of numberingOrg and idQualifier.</i>  (XPath KnitClothOrder/KCCObody/KCCOitem/phase/lotDetails/csRange/sizeMatrix/sizeRow/itemsList/itemIdentification/serialN) 1-9 (AU)</p> <hr/> <p><b>AAAA-WARNING! - text not AVAILABLE n. 245 - In=en</b>  - note: <i>multiple values of serialN are allowed for different representations of the serial identifier of the same product unit. Instances of serialN must differ at least for one value of numberingOrg and idQualifier.</i>  (XPath KnitClothOrder/KCCObody/KCCOitem/apparelComponent/fabricComponent/serialN) 0-unbounded (AU)</p> <p>- note: <i>it may be used to identify the pieces/chains that the Subcontractor must use for the commissioned work</i>  (XPath KnitClothOrder/KCCObody/KCCOitem/progress/itemsList/itemIdentification/serialN) 1-9 (AU)</p> <hr/> <p><b>AAAA-WARNING! - text not AVAILABLE n. 245 - In=en</b>  - note: <i>multiple values of serialN are allowed for different representations of the serial identifier of the same product unit. Instances of serialN must differ at least for one value of numberingOrg and idQualifier.</i>  (XPath KnitClothOrder/KCCObody/KCCOitem/endUseGroup/csRange/sizeMatrix/sizeRow/itemsList/itemIdentification/serialN) 1-9 (AU)</p> <hr/> <p><b>AAAA-WARNING! - text not AVAILABLE n. 245 - In=en</b>  - note: <i>multiple values of serialN are allowed for different representations of the serial identifier of the same product unit. Instances of serialN must differ at least for one value of numberingOrg and idQualifier.</i>  (XPath KnitClothOrder/KCCObody/KCCOitem/apparelComponent/fabricComponent/itemsList/itemIdentification/serialN) 1-9 (AU)</p> <hr/> <p><b>AAAA-WARNING! - text not AVAILABLE n. 245 - In=en</b>  - note: <i>multiple values of serialN are allowed for different representations of the serial identifier of the same product unit. Instances of serialN must differ at least for one value of numberingOrg and idQualifier.</i></p>
size	<p>size number of a fashion product (knitwear, clothing, ..)</p> <p>- base type: string, max length: 15,  (XPath KnitClothOrder/KCCObody/KCCOitem/garTecSheet/garmentCode/garmentCodeB/size) 0-1 (A)</p> <p>(XPath KnitClothOrder/KCCObody/KCCOitem/garTecSheet/garConsumptionSet/garmentCode/garmentCodeB/size) 0-1 (A)</p> <p>(XPath KnitClothOrder/KCCObody/KCCOitem/garTecSheet/garConsumptionSet/garmentPartCode/size) 0-1 (A)</p> <p>(XPath KnitClothOrder/KCCObody/KCCOitem/phase/lotDetails/csRange/sizeMatrix/sizeRow/size) 1-1 (A)</p>

	<p>(XPath KnitClothOrder/KCCObody/KCCOitem/apparelProd/garmentPartCode/size) 0-1 (A)</p> <p>(XPath KnitClothOrder/KCCObody/KCCOitem/phase/garConsumptionSet/garmentCode/garmentCodeB/size) 0-1 (A)</p> <p>(XPath KnitClothOrder/KCCObody/KCCOitem/phase/garConsumptionSet/garmentPartCode/size) 0-1 (A)</p> <p>(XPath KnitClothOrder/KCCObody/KCCOitem/garTecSheet/garMeaSet/garMea/size) 0-1 (A)</p> <p>(XPath KnitClothOrder/KCCObody/KCCOitem/apparelProd/csRange/sizeMatrix/sizeRow/size) 1-1 (A)</p> <p>(XPath KnitClothOrder/KCCObody/KCCOitem/apparelProd/garmentCode/garmentCodeB/size) 0-1 (A)</p> <p>(XPath KnitClothOrder/KCCObody/KCCOitem/apparelComponent/garmentPartComponent/garmentPartCode/size) 0-1 (A)</p> <p>(XPath KnitClothOrder/KCCObody/KCCOitem/endUseGroup/csRange/sizeMatrix/sizeRow/size) 1-1 (A)</p>
sizeEnd	<p>first size of a range of sizes</p> <p>- base type: string, max length: 15,</p> <p>(XPath KnitClothOrder/KCCObody/KCCOitem/garTecSheet/garSizeSet/garSizeTier/sizeEnd) 0-1</p>
sizeStart	<p>first size of a range of sizes</p> <p>- base type: string, max length: 15,</p> <p>(XPath KnitClothOrder/KCCObody/KCCOitem/garTecSheet/garSizeSet/garSizeTier/sizeStart) 1-1</p>
@sizeSystemBase	<p>base of the size system</p> <p>- base type: string, cod. table: T423</p> <p><a href="http://www.ebiz.enea.it/moda-ml/repository/codelist/v2018-1/gc_T423.xml">http://www.ebiz.enea.it/moda-ml/repository/codelist/v2018-1/gc_T423.xml</a></p> <p>(XPath KnitClothOrder/KCCObody/KCCOitem/endUseGroup/csRange/@sizeSystemBase) [Optional]</p> <p>(XPath KnitClothOrder/KCCObody/KCCOitem/phase/lotDetails/csRange/@sizeSystemBase) [Optional]</p> <p>(XPath KnitClothOrder/KCCObody/KCCOitem/apparelProd/csRange/@sizeSystemBase) [Optional]</p> <p>(XPath KnitClothOrder/KCCObody/KCCOitem/garTecSheet/garSizeSet/@sizeSystemBase) [Optional]</p>
@sizeSystemID	<p>the identifier of the size system.</p> <p>- base type: string,</p> <p>(XPath KnitClothOrder/KCCObody/KCCOitem/garTecSheet/garSizeSet/@sizeSystemID) [Optional]</p> <p>(XPath KnitClothOrder/KCCObody/KCCOitem/endUseGroup/csRange/@sizeSystemID) [Optional]</p> <p>(XPath KnitClothOrder/KCCObody/KCCOitem/phase/lotDetails/csRange/@sizeSystemID) [Optional]</p> <p>(XPath KnitClothOrder/KCCObody/KCCOitem/apparelProd/csRange/@sizeSystemID) [Optional]</p>
@sizeSystemNat	<p>nation or agency identifying the size system</p> <p>- base type: string, cod. table: T421</p> <p><a href="http://www.ebiz.enea.it/moda-ml/repository/codelist/v2018-1/gc_T421.xml">http://www.ebiz.enea.it/moda-ml/repository/codelist/v2018-1/gc_T421.xml</a></p> <p>(XPath KnitClothOrder/KCCObody/KCCOitem/endUseGroup/csRange/@sizeSystemNat) [Optional]</p> <p>(XPath KnitClothOrder/KCCObody/KCCOitem/phase/lotDetails/csRange/@sizeSystemNat) [Optional]</p> <p>(XPath KnitClothOrder/KCCObody/KCCOitem/apparelProd/csRange/@sizeSystemNat) [Optional]</p> <p>(XPath KnitClothOrder/KCCObody/KCCOitem/garTecSheet/garSizeSet/@sizeSystemNat) [Optional]</p>
@sizeSystemSeg	<p>market segment identifying the size system</p> <p>- base type: string, cod. table: T422</p> <p><a href="http://www.ebiz.enea.it/moda-ml/repository/codelist/v2018-1/gc_T422.xml">http://www.ebiz.enea.it/moda-ml/repository/codelist/v2018-1/gc_T422.xml</a></p>

	<p>(XPath KnitClothOrder/KCCObody/KCCOitem/apparelProd/csRange/@sizeSystemSeg) [Optional]</p> <p>(XPath KnitClothOrder/KCCObody/KCCOitem/phase/lotDetails/csRange/@sizeSystemSeg) [Optional]</p> <p>(XPath KnitClothOrder/KCCObody/KCCOitem/garTecSheet/garSizeSet/@sizeSystemSeg) [Optional]</p> <p>(XPath KnitClothOrder/KCCObody/KCCOitem/endUseGroup/csRange/@sizeSystemSeg) [Optional]</p>
sortableIndicator	<p>It states if the item can be automatically sorted.</p> <p>- base type: boolean,</p> <p>(XPath KnitClothOrder/KCCObody/KCCOitem/phase/packages/handlingChar/sortableIndicator) 0-1 (N)</p> <p>(XPath KnitClothOrder/KCCObody/KCCOitem/packages/handlingChar/sortableIndicator) 0-1 (N)</p>
@source	<p>party who has provided the data</p> <p>- base type: string, cod. table: NT12</p> <p><a href="http://www.ebiz.enea.it/moda-ml/repository/codelist/v2018-1/gc_NT12.xml">http://www.ebiz.enea.it/moda-ml/repository/codelist/v2018-1/gc_NT12.xml</a></p> <p>(XPath KnitClothOrder/KCCObody/KCCOitem/garTecSheet/garMeaSet/garMea/specValue/@source) [Optional]</p>
specDate	<p>date by which the referenced blanket order must receive full product specific ations (e.g.: colour), according to one of the patterns YYYY-MM-DD, YYYY-MM-DD:HH-MM or YYYY-WW.</p> <p>- base type: string,</p> <p>(XPath KnitClothOrder/garComInfo/specDate) 0-1 (p)</p> <p>(XPath KnitClothOrder/KCCObody/KCCOitem/garComInfo/specDate) 0-1 (p)</p>
specValue	<p>value requested for a property or a parameter that is measured</p> <p>- base type: decimal,</p> <p>(XPath KnitClothOrder/KCCObody/KCCOitem/garTecSheet/garMeaSet/garMea/specValue) 1-1</p>
stackabilityLevel	<p>This value indicates the level at which the item can be stacked.</p> <p>- base type: integer,</p> <p>(XPath KnitClothOrder/KCCObody/KCCOitem/phase/packages/handlingChar/stackabilityLevel) 0-1 (N)</p> <p>(XPath KnitClothOrder/KCCObody/KCCOitem/packages/handlingChar/stackabilityLevel) 0-1 (N)</p>
statusReason	<p>the reason for the indicated status.</p> <p>- base type: string,</p> <p>(XPath KnitClothOrder/KCCObody/KCCOitem/progress/statusReason) 0-1 (N)</p>
street	<p>street and building number identifying a location</p> <p>- base type: string, max length: 80,</p> <p>(XPath KnitClothOrder/KCCOheader/subContractor/street) 0-1</p> <p>(XPath KnitClothOrder/KCCObody/KCCOitem/thirdParty/street) 0-1</p> <p>(XPath KnitClothOrder/KCCOheader/thirdParty/street) 0-1</p> <p>(XPath KnitClothOrder/KCCOheader/buyer/street) 0-1</p> <p>(XPath KnitClothOrder/KCCObody/KCCOitem/phase/thirdParty/street) 0-1</p>
subCountry	<p>short name or code of the sub-country entity</p> <p>- base type: string, max length: 9,</p> <p>(XPath KnitClothOrder/KCCOheader/subContractor/subCountry) 0-1</p> <p>(XPath KnitClothOrder/KCCObody/KCCOitem/phase/thirdParty/subCountry) 0-1</p> <p>(XPath KnitClothOrder/KCCOheader/buyer/subCountry) 0-1</p> <p>(XPath KnitClothOrder/KCCObody/KCCOitem/thirdParty/subCountry) 0-1</p> <p>(XPath KnitClothOrder/KCCOheader/thirdParty/subCountry) 0-1</p>
subDept	<p>name or code of a contact department within a Party</p> <p>- base type: string, max length: 40,</p> <p>(XPath KnitClothOrder/KCCObody/KCCOitem/thirdParty/subDept) 0-1 (N)</p> <p>(XPath KnitClothOrder/KCCOheader/buyer/subDept) 0-1 (N)</p> <p>(XPath KnitClothOrder/KCCObody/KCCOitem/phase/thirdParty/subDept) 0-1 (N)</p> <p>(XPath KnitClothOrder/KCCOheader/subContractor/subDept) 0-1 (N)</p> <p>(XPath KnitClothOrder/KCCOheader/thirdParty/subDept) 0-1 (N)</p>

<b>@subject</b>	<p>qualifier of the product treated in the note</p> <p>- base type: string, cod. table: NT40  <a href="http://www.ebiz.enea.it/moda-ml/repository/codelist/v2018-1/gc_NT40.xml">http://www.ebiz.enea.it/moda-ml/repository/codelist/v2018-1/gc_NT40.xml</a>  (XPath KnitClothOrder/KCCObody/KCCOitem/garTecSheet/mnfrNote/@subject) [Optional]  (XPath KnitClothOrder/KCCObody/KCCOitem/garTecSheet/image/@subject) [Optional]</p>
<b>taxCategory</b>	<p>duty or tax or fee category</p> <p>- base type: string, cod. table: T62  <a href="http://www.ebiz.enea.it/moda-ml/repository/codelist/v2018-1/gc_T62.xml">http://www.ebiz.enea.it/moda-ml/repository/codelist/v2018-1/gc_T62.xml</a>  (XPath KnitClothOrder/terms/allowanceCharge/dtScheme/taxCategory) 0-1  (XPath KnitClothOrder/KCCObody/KCCOitem/dtScheme/taxCategory) 0-1</p>
<b>taxRate</b>	<p>duty or tax or fee percent rate</p> <p>- base type: string,  (XPath KnitClothOrder/KCCObody/KCCOitem/dtScheme/taxRate) 0-1  (XPath KnitClothOrder/terms/allowanceCharge/dtScheme/taxRate) 0-1</p>
<b>@taxType</b>	<p>duty or tax or fee type</p> <p>- base type: string, cod. table: T61  <a href="http://www.ebiz.enea.it/moda-ml/repository/codelist/v2018-1/gc_T61.xml">http://www.ebiz.enea.it/moda-ml/repository/codelist/v2018-1/gc_T61.xml</a>  (XPath KnitClothOrder/KCCObody/KCCOitem/dtScheme/@taxType) [Required]  (XPath KnitClothOrder/terms/allowanceCharge/dtScheme/@taxType) [Required]</p>
<b>@TID</b>	<p>serial number wired into the RFID chip</p> <p>- base type: string,  (XPath KnitClothOrder/KCCObody/KCCOitem/phase/packages/EPClist/EPC/@TID) [Optional]  (XPath KnitClothOrder/KCCObody/KCCOitem/packages/EPClist/EPC/@TID) [Optional]</p>
<b>transCondition</b>	<p>special condition of transport or special service requested to the Forwarder</p> <p>- base type: string, cod. table: T38  <a href="http://www.ebiz.enea.it/moda-ml/repository/codelist/v2018-1/gc_T38.xml">http://www.ebiz.enea.it/moda-ml/repository/codelist/v2018-1/gc_T38.xml</a>  (XPath KnitClothOrder/terms/transInfo/transCondition) 0-3</p>
<b>transConditionText</b>	<p>free text description of the special condition of transport or special service requested to the Forwarder</p> <p>- base type: string, max length: 250,  (XPath KnitClothOrder/terms/transInfo/transConditionText) 0-1 (U)</p>
<b>transMeans</b>	<p>means of transport, in general or referred to a specific leg</p> <p>- base type: string, cod. table: T40  <a href="http://www.ebiz.enea.it/moda-ml/repository/codelist/v2018-1/gc_T40.xml">http://www.ebiz.enea.it/moda-ml/repository/codelist/v2018-1/gc_T40.xml</a>  (XPath KnitClothOrder/terms/transInfo/transMeans) 0-1</p>
<b>transMode</b>	<p>way of transport, in general or referred to the specified leg</p> <p>- base type: string, cod. table: T8  <a href="http://www.ebiz.enea.it/moda-ml/repository/codelist/v2018-1/gc_T8.xml">http://www.ebiz.enea.it/moda-ml/repository/codelist/v2018-1/gc_T8.xml</a>  (XPath KnitClothOrder/terms/transInfo/transMode) 1-1</p>
<b>@transReason</b>	<p>reason for the transport</p> <p>- base type: string, cod. table: NT11  <a href="http://www.ebiz.enea.it/moda-ml/repository/codelist/v2018-1/gc_NT11.xml">http://www.ebiz.enea.it/moda-ml/repository/codelist/v2018-1/gc_NT11.xml</a>  (XPath KnitClothOrder/terms/transInfo/@transReason) [Optional]</p>
<b>@uid</b>	<p>unique element identifier within the xml document</p> <p>- base type: string,  (XPath KnitClothOrder/KCCObody/KCCOitem/appMnfrOperation/refDoc/attachment/@uid) [Optional]  (XPath KnitClothOrder/KCCObody/KCCOitem/garTecSheet/refDoc/attachment/@uid) [Optional]  (XPath KnitClothOrder/KCCObody/KCCOitem/phase/refDoc/attachment/@uid) [Optional]  (XPath KnitClothOrder/KCCObody/KCCOitem/apparelComponent/fabricComponent/refDoc/attachment/@uid) [Optional]</p>

	<p>(XPath KnitClothOrder/KCCObody/KCCOitem/apparelComponent/acsComponent/refDoc/attachment/@uid) [Optional]</p> <p>(XPath KnitClothOrder/KCCOheader/refDoc/attachment/@uid) [Optional]</p> <p>(XPath KnitClothOrder/KCCObody/KCCOitem/apparelComponent/yarnComponent/refDoc/attachment/@uid) [Optional]</p> <p>(XPath KnitClothOrder/KCCObody/KCCOitem/apparelComponent/garmentPartComponent/refDoc/attachment/@uid) [Optional]</p>
@um	<p>specification of the unit of measure  - base type: string, cod. table: NT7  <a href="http://www.ebiz.enea.it/moda-ml/repository/codelist/v2018-1/gc_NT7.xml">http://www.ebiz.enea.it/moda-ml/repository/codelist/v2018-1/gc_NT7.xml</a></p> <p>(XPath KnitClothOrder/KCCObody/KCCOitem/garTecSheet/garMeaSet/garMea/specValue/@um) [Optional]</p> <p>(XPath KnitClothOrder/KCCObody/KCCOitem/apparelComponent/acsComponent/qty/@um) [Required]</p> <p>(XPath KnitClothOrder/KCCObody/KCCOitem/garTecSheet/garConsumptionSet/garConsumption/qty/@um) [Required]</p> <p>(XPath KnitClothOrder/KCCObody/KCCOitem/garTecSheet/netWeight/@um) [Required]</p> <p>(XPath KnitClothOrder/KCCObody/KCCOitem/packages/packageDim/height/@um) [Required]</p> <p>(XPath KnitClothOrder/KCCObody/KCCOitem/packages/packageDim/width/@um) [Required]</p> <p>(XPath KnitClothOrder/KCCObody/KCCOitem/packages/packageDim/length/@um) [Required]</p> <p>(XPath KnitClothOrder/KCCObody/KCCOitem/packages/handlingChar/yarnPack/yarnReel/yarnReelD/@um) [Required]</p> <p>(XPath KnitClothOrder/KCCObody/KCCOitem/packages/handlingChar/yarnPack/yarnReel/yarnReelH/@um) [Required]</p> <p>(XPath KnitClothOrder/KCCObody/KCCOitem/packages/handlingChar/yarnPack/yarnReel/yarnReelQty/@um) [Required]</p> <p>(XPath KnitClothOrder/KCCObody/KCCOitem/apparelComponent/garmentPartComponent/qty/@um) [Required]</p> <p>(XPath KnitClothOrder/KCCObody/KCCOitem/packages/itemsPerPackage/@um) [Required]</p> <p>(XPath KnitClothOrder/KCCObody/KCCOitem/packages/minItemsPerPackage/@um) [Required]</p> <p>(XPath KnitClothOrder/KCCObody/KCCOitem/garTecSheet/grossWeight/@um) [Required]</p> <p>(XPath KnitClothOrder/KCCObody/KCCOitem/packages/handlingChar/volume/@um) [Required]</p> <p>(XPath KnitClothOrder/KCCObody/KCCOitem/packages/handlingChar/netWeight/@um) [Required]</p> <p>(XPath KnitClothOrder/KCCObody/KCCOitem/packages/handlingChar/grossWeight/@um) [Required]</p> <p>(XPath KnitClothOrder/KCCObody/KCCOitem/garComInfo/yarnPack/yarnReel/yarnReelH/@um) [Required]</p> <p>(XPath KnitClothOrder/KCCObody/KCCOitem/garComInfo/yarnPack/yarnReel/yarnReelQty/@um) [Required]</p> <p>(XPath KnitClothOrder/KCCObody/KCCOitem/garComInfo/yarnPack/yarnReel/yarnReelD/@um) [Required]</p> <p>(XPath KnitClothOrder/KCCObody/KCCOitem/apparelComponent/fabricComponent/qty/@um) [Required]</p> <p>(XPath KnitClothOrder/KCCObody/KCCOitem/phase/packages/packageDim/height/@um) [Required]</p> <p>(XPath KnitClothOrder/garComInfo/yarnPack/yarnReel/yarnReelQty/@um) [Required]</p> <p>(XPath KnitClothOrder/KCCObody/KCCOitem/phase/packages/packageDim/length/@um) [Required]</p> <p>(XPath KnitClothOrder/KCCObody/KCCOitem/phase/garConsumptionSet/garConsumption/qtyVariance/@um) [Optional]</p> <p>(XPath KnitClothOrder/KCCObody/KCCOitem/phase/packages/packageDim/width/@um) [Required]</p> <p>(XPath KnitClothOrder/garComInfo/yarnPack/yarnReel/yarnReelH/@um) [Required]</p> <p>(XPath KnitClothOrder/garComInfo/yarnPack/yarnReel/yarnReelD/@um) [Required]</p>

	<p>(XPath KnitClothOrder/KCCObody/KCCOitem/phase/packages/handlingChar/yarnPack/yarnReel/yarnReelID/@um) [Required]</p> <p>(XPath KnitClothOrder/KCCObody/KCCOitem/phase/packages/handlingChar/grossWeight/@um) [Required]</p> <p>(XPath KnitClothOrder/KCCObody/KCCOitem/apparelComponent/yarnComponent/qty/@um) [Required]</p> <p>(XPath KnitClothOrder/KCCObody/KCCOitem/phase/lotDetails/csRange/sizeMatrix/sizeRow/qty/@um) [Required]</p> <p>(XPath KnitClothOrder/KCCObody/KCCOitem/phase/packages/handlingChar/volume/@um) [Required]</p> <p>(XPath KnitClothOrder/KCCObody/KCCOitem/phase/packages/handlingChar/netWeight/@um) [Required]</p> <p>(XPath KnitClothOrder/KCCObody/KCCOitem/phase/packages/itemsPerPackage/@um) [Required]</p> <p>(XPath KnitClothOrder/KCCObody/KCCOitem/phase/packages/handlingChar/yarnPack/yarnReel/yarnReelQty/@um) [Required]</p> <p>(XPath KnitClothOrder/KCCObody/KCCOitem/phase/packages/handlingChar/yarnPack/yarnReel/yarnReelH/@um) [Required]</p> <p>(XPath KnitClothOrder/KCCObody/KCCOitem/apparelComponent/yarnComponent/pcQty/@um) [Optional]</p> <p>- nota: <i>to be used when it has to be soecified if the declared percentage is b y weight, volume, etc...</i></p> <p>(XPath KnitClothOrder/KCCObody/KCCOitem/phase/packages/minItemsPerPackage/@um) [Required]</p> <p>(XPath KnitClothOrder/KCCObody/KCCOitem/apparelProd/qty/@um) [Required]</p> <p>(XPath KnitClothOrder/KCCObody/KCCOitem/phase/qty/@um) [Required]</p> <p>(XPath KnitClothOrder/terms/allowanceCharge/@um) [Optional] (a)</p> <p>(XPath KnitClothOrder/terms/transInfo/grossWeight/@um) [Required]</p> <p>(XPath KnitClothOrder/KCCObody/KCCOitem/endUseGroup/qty/@um) [Required]</p> <p>(XPath KnitClothOrder/KCCObody/KCCOitem/garTecSheet/garConsumptionSet/garConsumption/qtyVariance/@um) [Optional]</p> <p>(XPath KnitClothOrder/KCCObody/KCCOitem/progress/qty/@um) [Required]</p> <p>(XPath KnitClothOrder/KCCObody/KCCOitem/apparelProd/csRange/sizeMatrix/sizeRow/qty/@um) [Required]</p> <p>(XPath KnitClothOrder/KCCObody/KCCOitem/phase/garConsumptionSet/garConsumption/qty/@um) [Required]</p> <p>(XPath KnitClothOrder/KCCObody/KCCOitem/phase/price/@um) [Optional]</p> <p>- nota: <i>Unit of measure of the product to which the price is referred (price pe r meter)</i></p> <p>(XPath KnitClothOrder/KCCObody/KCCOitem/phase/lotDetails/qty/@um) [Required]</p> <p>(XPath KnitClothOrder/KCCObody/KCCOitem/price/@um) [Optional]</p> <p>- nota: <i>Unit of measure of the product to which the price is referred (price pe r meter)</i></p> <p>(XPath KnitClothOrder/terms/transInfo/netWeight/@um) [Required]</p> <p>(XPath KnitClothOrder/KCCObody/KCCOitem/endUseGroup/csRange/sizeMatrix/sizeRow/qty/@um) [Required]</p>
uri	<p>Uniform Resource Identifier (URI) that identifies the external object as an Internet resource</p> <p>- base type: normalizedString,</p> <p>(XPath KnitClothOrder/KCCObody/KCCOitem/apparelComponent/garmentPartComponent/refDoc/attachment/externalReference/uri) 1-1 (N)</p> <p>(XPath KnitClothOrder/KCCObody/KCCOitem/appMnfrOperation/refDoc/attachment/externalReference/uri) 1-1 (N)</p> <p>(XPath KnitClothOrder/KCCObody/KCCOitem/apparelComponent/yarnComponent/refDoc/attachment/externalReference/uri) 1-1 (N)</p> <p>(XPath KnitClothOrder/KCCObody/KCCOitem/apparelComponent/fabricComponent/refDoc/attachment/externalReference/uri) 1-1 (N)</p> <p>(XPath KnitClothOrder/KCCOheader/refDoc/attachment/externalReference/uri) 1-1 (N)</p> <p>(XPath KnitClothOrder/KCCObody/KCCOitem/apparelComponent/acsComponent/refDoc/attachment/externalReference/uri) 1-1 (N)</p> <p>(XPath KnitClothOrder/KCCObody/KCCOitem/garTecSheet/refDoc/attachment/externalReference/uri) 1-1 (N)</p>



	(XPath KnitClothOrder/KCCObody/KCCOitem/phase/refDoc/attachment/externalReference/uri) 1-1 (N)
@useProfile	use profile to which the present document is compliant if it was agreed by the parties. It is suggested a URI with reference to the firms or the URL of the profile. - base type: string, (XPath KnitClothOrder/@useProfile) [Optional]
validityEnd	date by which the validity ends, according to one of the patterns YYYY-MM-DD, YYYY-MM-DD:HH-MM or YYYY-WW. - base type: string, (XPath KnitClothOrder/KCCOheader/validityEnd) 0-1 (p)
validityStart	date by which the validity starts, according to one of the patterns YYYY-MM-DD, YYYY-MM-DD:HH-MM or YYYY-WW. - base type: string, (XPath KnitClothOrder/KCCOheader/validityStart) 0-1 (p)
variantCode	Code of variant used for fashion product. - base type: string, (XPath KnitClothOrder/KCCObody/KCCOitem/phase/lotDetails/csRange/garmentVariant/variantCode) 1-1 (N) (XPath KnitClothOrder/KCCObody/KCCOitem/apparelProd/garmentCode/garmentCodeB/garmentVariant/variantCode) 1-1 (N) (XPath KnitClothOrder/KCCObody/KCCOitem/garTecSheet/garConsumptionSet/garmentCode/garmentCodeB/garmentVariant/variantCode) 1-1 (N) (XPath KnitClothOrder/KCCObody/KCCOitem/apparelProd/csRange/garmentVariant/variantCode) 1-1 (N) (XPath KnitClothOrder/KCCObody/KCCOitem/endUseGroup/csRange/garmentVariant/variantCode) 1-1 (N) (XPath KnitClothOrder/KCCObody/KCCOitem/garTecSheet/garmentCode/garmentCodeB/garmentVariant/variantCode) 1-1 (N) (XPath KnitClothOrder/KCCObody/KCCOitem/phase/garConsumptionSet/garmentCode/garmentCodeB/garmentVariant/variantCode) 1-1 (N)
variantType	Type of variant used for fashion product (examples: 'treatment', 'washing type', 'size class',...) - base type: string, (XPath KnitClothOrder/KCCObody/KCCOitem/endUseGroup/csRange/garmentVariant/variantType) 1-1 (N) (XPath KnitClothOrder/KCCObody/KCCOitem/garTecSheet/garmentCode/garmentCodeB/garmentVariant/variantType) 1-1 (N) (XPath KnitClothOrder/KCCObody/KCCOitem/phase/garConsumptionSet/garmentCode/garmentCodeB/garmentVariant/variantType) 1-1 (N) (XPath KnitClothOrder/KCCObody/KCCOitem/phase/lotDetails/csRange/garmentVariant/variantType) 1-1 (N) (XPath KnitClothOrder/KCCObody/KCCOitem/garTecSheet/garConsumptionSet/garmentCode/garmentCodeB/garmentVariant/variantType) 1-1 (N) (XPath KnitClothOrder/KCCObody/KCCOitem/apparelProd/garmentCode/garmentCodeB/garmentVariant/variantType) 1-1 (N) (XPath KnitClothOrder/KCCObody/KCCOitem/apparelProd/csRange/garmentVariant/variantType) 1-1 (N)
@varReason	reason for the difference between the two quantities specified by the context - base type: string, cod. table: T46 <a href="http://www.ebiz.enea.it/moda-ml/repository/codelist/v2018-1/gc_T46.xml">http://www.ebiz.enea.it/moda-ml/repository/codelist/v2018-1/gc_T46.xml</a> (XPath KnitClothOrder/KCCObody/KCCOitem/phase/garConsumptionSet/garConsumption/qtyVariance/@varReason) [Optional] (XPath KnitClothOrder/KCCObody/KCCOitem/garTecSheet/garConsumptionSet/garConsumption/qtyVariance/@varReason) [Optional]

@VAT	VAT rate or code (DEPRECATED, use dtScheme element) - base type: string, cod. table: NT16 <a href="http://www.ebiz.enea.it/moda-ml/repository/codelist/v2018-1/gc_NT16.xml">http://www.ebiz.enea.it/moda-ml/repository/codelist/v2018-1/gc_NT16.xml</a> (XPath KnitClothOrder/terms/allowanceCharge/@VAT) [Optional] (XPath KnitClothOrder/KCCOheader/thirdParty/@VAT) [Optional] (XPath KnitClothOrder/KCCObody/KCCOitem/lineN/@VAT) [Optional] - nota: <i>Deprecated, prefer dtScheme when available.</i> (XPath KnitClothOrder/KCCObody/KCCOitem/thirdParty/@VAT) [Optional] (XPath KnitClothOrder/KCCObody/KCCOitem/phase/thirdParty/@VAT) [Optional]
@version	Dictionary version from which the instance has been created - base type: string, cod. table: NT100 <a href="http://www.ebiz.enea.it/moda-ml/repository/codelist/v2018-1/gc_NT100.xml">http://www.ebiz.enea.it/moda-ml/repository/codelist/v2018-1/gc_NT100.xml</a> (XPath KnitClothOrder/@version) [Optional] [Default= 2018-1]
volume	effective volume of a specified object - base type: decimal, min inclusive: 0, fraction digits: 2, (XPath KnitClothOrder/KCCObody/KCCOitem/phase/packages/handlingChar/volume) 0-1 (XPath KnitClothOrder/KCCObody/KCCOitem/packages/handlingChar/volume) 0-1
warpLetter	letter that indicates a specific yarn in the warping formula (diagram) - base type: string, length: 1, (XPath KnitClothOrder/KCCObody/KCCOitem/apparelComponent/yarnComponent/warpLetter) 0-1 - note: <i>to be used only in the Warping order</i>
weftLetter	letter that indicates a specific yarn in the wefting formula (diagram) - base type: string, length: 1, (XPath KnitClothOrder/KCCObody/KCCOitem/apparelComponent/yarnComponent/weftLetter) 0-1 - note: <i>to be used only in the Weaving order</i>
width	effective width of a specified object - base type: decimal, min inclusive: 0, fraction digits: 2, (XPath KnitClothOrder/KCCObody/KCCOitem/packages/packageDim/width) 0-1 (XPath KnitClothOrder/KCCObody/KCCOitem/phase/packages/packageDim/width) 0-1
yarnConeAngle	tapering angle of the cone on which a yarn is reeled - base type: positiveInteger, (XPath KnitClothOrder/KCCObody/KCCOitem/garComInfo/yarnPack/yarnReel/yarnConeAngle) 0-1 (XPath KnitClothOrder/KCCObody/KCCOitem/phase/packages/handlingChar/yarnPack/yarnReel/yarnConeAngle) 0-1 (XPath KnitClothOrder/garComInfo/yarnPack/yarnReel/yarnConeAngle) 0-1 (XPath KnitClothOrder/KCCObody/KCCOitem/packages/handlingChar/yarnPack/yarnReel/yarnConeAngle) 0-1
yarnOutWrap	code specifying the type of outer wrapping or packing of a yarn - base type: string, cod. table: T33 <a href="http://www.ebiz.enea.it/moda-ml/repository/codelist/v2018-1/gc_T33.xml">http://www.ebiz.enea.it/moda-ml/repository/codelist/v2018-1/gc_T33.xml</a> (XPath KnitClothOrder/KCCObody/KCCOitem/packages/handlingChar/yarnPack/yarnOutWrap) 0-1 (XPath KnitClothOrder/KCCObody/KCCOitem/phase/packages/handlingChar/yarnPack/yarnOutWrap) 0-1 (XPath KnitClothOrder/garComInfo/yarnPack/yarnOutWrap) 0-1 (XPath KnitClothOrder/KCCObody/KCCOitem/garComInfo/yarnPack/yarnOutWrap) 0-1
yarnOutWrapText	free text specifying the type of outer wrapping or packing of a yarn - base type: string, max length: 250, (XPath KnitClothOrder/KCCObody/KCCOitem/phase/packages/handlingChar/yarnPack/yarnOutWrapText) 0-1 (U) (XPath KnitClothOrder/KCCObody/KCCOitem/packages/handlingChar/yarnPack/yarnOutWrapText) 0-1 (U)

	<p>(XPath KnitClothOrder/KCCObody/KCCOitem/garComInfo/yarnPack/yarnOutWrapText) 0-1 (U)</p> <p>(XPath KnitClothOrder/garComInfo/yarnPack/yarnOutWrapText) 0-1 (U)</p>
yarnReelD	<p>diameter of the bobbin used for a yarn product</p> <p>- base type: decimal, min inclusive: 0, fraction digits: 2,</p> <p>(XPath KnitClothOrder/KCCObody/KCCOitem/garComInfo/yarnPack/yarnReel/yarnReelD) 0-1</p> <p>(XPath KnitClothOrder/garComInfo/yarnPack/yarnReel/yarnReelD) 0-1</p> <p>(XPath KnitClothOrder/KCCObody/KCCOitem/packages/handlingChar/yarnPack/yarnReel/yarnReelD) 0-1</p> <p>(XPath KnitClothOrder/KCCObody/KCCOitem/phase/packages/handlingChar/yarnPack/yarnReel/yarnReelD) 0-1</p>
yarnReelH	<p>height of the bobbin used a yarn product</p> <p>- base type: decimal, min inclusive: 0, fraction digits: 2,</p> <p>(XPath KnitClothOrder/KCCObody/KCCOitem/garComInfo/yarnPack/yarnReel/yarnReelH) 0-1</p> <p>(XPath KnitClothOrder/KCCObody/KCCOitem/packages/handlingChar/yarnPack/yarnReel/yarnReelH) 0-1</p> <p>(XPath KnitClothOrder/garComInfo/yarnPack/yarnReel/yarnReelH) 0-1</p> <p>(XPath KnitClothOrder/KCCObody/KCCOitem/phase/packages/handlingChar/yarnPack/yarnReel/yarnReelH) 0-1</p>
yarnReelQty	<p>quantity of yarn (by weight or length) wound upon a bobbin</p> <p>- base type: decimal, min inclusive: 0, fraction digits: 2,</p> <p>(XPath KnitClothOrder/KCCObody/KCCOitem/garComInfo/yarnPack/yarnReel/yarnReelQty) 0-2</p> <p>(XPath KnitClothOrder/KCCObody/KCCOitem/packages/handlingChar/yarnPack/yarnReel/yarnReelQty) 0-2</p> <p>(XPath KnitClothOrder/garComInfo/yarnPack/yarnReel/yarnReelQty) 0-2</p> <p>(XPath KnitClothOrder/KCCObody/KCCOitem/phase/packages/handlingChar/yarnPack/yarnReel/yarnReelQty) 0-2</p>
yarnReelWrap	<p>type of wrapping in which a package of yarn is wrapped</p> <p>- base type: string, cod. table: T32</p> <p><a href="http://www.ebiz.enea.it/moda-ml/repository/codelist/v2018-1/gc_T32.xml">http://www.ebiz.enea.it/moda-ml/repository/codelist/v2018-1/gc_T32.xml</a></p> <p>(XPath KnitClothOrder/KCCObody/KCCOitem/garComInfo/yarnPack/yarnInWrap/yarnReelWrap) 1-1</p> <p>(XPath KnitClothOrder/KCCObody/KCCOitem/phase/packages/handlingChar/yarnPack/yarnInWrap/yarnReelWrap) 1-1</p> <p>(XPath KnitClothOrder/KCCObody/KCCOitem/packages/handlingChar/yarnPack/yarnInWrap/yarnReelWrap) 1-1</p> <p>(XPath KnitClothOrder/garComInfo/yarnPack/yarnInWrap/yarnReelWrap) 1-1</p>

## 2.3 Suggested best practices

**KnitClothOrder/KCCObody/KCCOitem/phase/refDoc/docID (identification number of the referenced document SINCE 2008-1 ITS USE IN THE HEADER IS DISCOURAGED (REPLACED BY msgID))**

numberingOrg indicates the role that produced the document identifier (it is allowed to declare two different ones -e.g. customer and supplier - with two docID with different numberingOrg

**KnitClothOrder/KCCObody/KCCOitem/apparelComponent/**

**acsComponent/refDoc/docID (identification number of the referenced document SINCE 2008-1 ITS USE IN THE HEADER IS DISCOURAGED (REPLACED BY msgID))**

numberingOrg indicates the role that produced the document identifier (it is allowed to declare two different ones -e.g. customer and supplier - with two docID with different numberingOrg

**KnitClothOrder/KCCObody/KCCOitem/apparelComponent/**

**fabricComponent/refDoc/docID (identification number of the referenced document SINCE 2008-1 ITS USE IN THE HEADER IS DISCOURAGED (REPLACED BY msgID))**

numberingOrg indicates the role that produced the document identifier (it is allowed to declare two different ones -e.g. customer and supplier - with two docID with different numberingOrg

**KnitClothOrder/KCCObody/KCCOitem/appMnfrOperation/**

**refDoc/docID (identification number of the referenced document SINCE 2008-1 ITS USE IN THE HEADER IS DISCOURAGED (REPLACED BY msgID))**

numberingOrg indicates the role that produced the document identifier (it is allowed to declare two different ones -e.g. customer and supplier - with two docID with different numberingOrg

**KnitClothOrder/KCCObody/KCCOitem/apparelComponent/**

**garmentPartComponent/refDoc/docID (identification number of the referenced document SINCE 2008-1 ITS USE IN THE HEADER IS DISCOURAGED (REPLACED BY msgID))**

numberingOrg indicates the role that produced the document identifier (it is allowed to declare two different ones -e.g. customer and supplier - with two docID with different numberingOrg

**KnitClothOrder/KCCOheader/refDoc/docID (identification number of the referenced document SINCE 2008-1 ITS USE IN THE HEADER IS DISCOURAGED (REPLACED BY msgID))**

numberingOrg indicates the role that produced the document identifier (it is allowed to declare two different ones -e.g. customer and supplier - with two docID with different numberingOrg

**KnitClothOrder/KCCObody/KCCOitem/garTecSheet/**

**refDoc/docID (identification number of the referenced document SINCE 2008-1 ITS USE IN THE HEADER IS DISCOURAGED (REPLACED BY msgID))**

numberingOrg indicates the role that produced the document identifier (it is allowed to declare two different ones -e.g. customer and supplier - with two docID with different numberingOrg

**KnitClothOrder/KCCObody/KCCOitem/apparelComponent/**

**yarnComponent/refDoc/docID (identification number of the referenced document SINCE 2008-1 ITS USE IN THE HEADER IS DISCOURAGED (REPLACED BY msgID))**

numberingOrg indicates the role that produced the document identifier (it is allowed to declare two different ones -e.g. customer and supplier - with two docID with different numberingOrg

**KnitClothOrder/KCCObody/KCCOitem/appMnfrOperation/**

**refDoc/attachment/externalReference/mimeCode (mime type of the external object)**

Use coding from IANA <http://www.iana.org/assignments/media-types/media-types.xml>

**KnitClothOrder/KCCObody/KCCOitem/apparelComponent/  
yarnComponent/refDoc/attachment/externalReference/mimeType** (mime type of the external object)

Use coding from IANA <http://www.iana.org/assignments/media-types/media-types.xml>

**KnitClothOrder/KCCObody/KCCOitem/apparelComponent/  
fabricComponent/refDoc/attachment/externalReference/mimeType** (mime type of the external object)

Use coding from IANA <http://www.iana.org/assignments/media-types/media-types.xml>

**KnitClothOrder/KCCObody/KCCOitem/garTecSheet/  
refDoc/attachment/externalReference/mimeType** (mime type of the external object)

Use coding from IANA <http://www.iana.org/assignments/media-types/media-types.xml>

**KnitClothOrder/KCCObody/KCCOitem/phase/refDoc/  
attachment/externalReference/mimeType** (mime type of the external object)

Use coding from IANA <http://www.iana.org/assignments/media-types/media-types.xml>

**KnitClothOrder/KCCOheader/refDoc/attachment/  
externalReference/mimeType** (mime type of the external object)

Use coding from IANA <http://www.iana.org/assignments/media-types/media-types.xml>

**KnitClothOrder/KCCObody/KCCOitem/apparelComponent/  
garmentPartComponent/refDoc/attachment/externalReference/mimeType** (mime type of the external object)

Use coding from IANA <http://www.iana.org/assignments/media-types/media-types.xml>

**KnitClothOrder/KCCObody/KCCOitem/apparelComponent/  
acsComponent/refDoc/attachment/externalReference/mimeType** (mime type of the external object)

Use coding from IANA <http://www.iana.org/assignments/media-types/media-types.xml>

**KnitClothOrder/KCCObody/KCCOitem/apparelComponent/  
yarnComponent/qty** (net quantity of the article or object correlated, qualified by the function of the document (ordering, delivering, ..) and by the context)

this element can have two instances only if the units of measure are different

**KnitClothOrder/KCCObody/KCCOitem/apparelProd/qty** (net quantity of the article or object correlated, qualified by the function of the document (ordering, delivering, ..) and by the context)

this element can have two instances only if the units of measure are different

**KnitClothOrder/KCCObody/KCCOitem/progress/qty** (net quantity of the article or object correlated, qualified by the function of the document (ordering, delivering, ..) and by the context)

this element can have two instances only if the units of measure are different

**KnitClothOrder/KCCObody/KCCOitem/phase/qty** (net quantity of the article or object correlated, qualified by the function of the document (ordering, delivering, ..) and by the context)

this element can have two instances only if the units of measure are different

**KnitClothOrder/KCCObody/KCCOitem/apparelComponent/  
garmentPartComponent/qty** (net quantity of the article or object correlated, qualified by the function of the document (ordering, delivering, ..) and by the context)

this element can have two instances only if the units of measure are different

**KnitClothOrder/KCCObody/KCCOitem/apparelComponent/**

**acsComponent/qty** (net quantity of the article or object correlated, qualified by the function of the document (ordering, delivering, ..) and by the context)

this element can have two instances only if the units of measure are different

**KnitClothOrder/KCCObody/KCCOitem/apparelProd/**

**csRange/sizeMatrix/sizeRow/itemsList/itemIdentification/serialN** (serial number used for the identification of a physical unit)

in the case of garment with RFID for anti-counterfeiting, RFID EPCGlobal for logistics and NFC for the customer experience there should be three serial elements with pairs of attributes numberingOrg/idQualifier: "CL"/"RFID", "GS1"/"RFID", "CL"/"NFC".

**KnitClothOrder/KCCObody/KCCOitem/phase/lotDetails/**

**csRange/sizeMatrix/sizeRow/itemsList/itemIdentification/serialN** (serial number used for the identification of a physical unit)

in the case of garment with RFID for anti-counterfeiting, RFID EPCGlobal for logistics and NFC for the customer experience there should be three serial elements with pairs of attributes numberingOrg/idQualifier: "CL"/"RFID", "GS1"/"RFID", "CL"/"NFC".

**KnitClothOrder/KCCObody/KCCOitem/progress/**

**itemsList/itemIdentification/serialN** (serial number used for the identification of a physical unit)

in the case of garment with RFID for anti-counterfeiting, RFID EPCGlobal for logistics and NFC for the customer experience there should be three serial elements with pairs of attributes numberingOrg/idQualifier: "CL"/"RFID", "GS1"/"RFID", "CL"/"NFC".

**KnitClothOrder/KCCObody/KCCOitem/endUseGroup/**

**csRange/sizeMatrix/sizeRow/itemsList/itemIdentification/serialN** (serial number used for the identification of a physical unit)

in the case of garment with RFID for anti-counterfeiting, RFID EPCGlobal for logistics and NFC for the customer experience there should be three serial elements with pairs of attributes numberingOrg/idQualifier: "CL"/"RFID", "GS1"/"RFID", "CL"/"NFC".

**KnitClothOrder/KCCObody/KCCOitem/apparelComponent/**

**fabricComponent/itemsList/itemIdentification/serialN** (serial number used for the identification of a physical unit)

in the case of garment with RFID for anti-counterfeiting, RFID EPCGlobal for logistics and NFC for the customer experience there should be three serial elements with pairs of attributes numberingOrg/idQualifier: "CL"/"RFID", "GS1"/"RFID", "CL"/"NFC".



## 2.4 Enumeration tables

List of enumeration tables used in the XML document. You can find the corresponding codes at:  
<http://www.ebiz-tcf.eu/moda-ml/imple/moda-ml-2018-1.asp?lingua=en&pag=6>

### Legenda

- N: new table
- U: updated properties

NT1 - Order type  
NT100 - eBIZ TCFUpstream version  
NT11 - transport causal  
NT12 - data source  
NT16 - VAT rate or code  
NT18 - message function  
NT2 - third party qualifier  
NT20 - price qualifier  
NT22 - product type of an operation  
NT29 - format of a date  
NT3 - data format  
NT37 - committed quantity qualifier  
NT39 - consumption type (N)  
NT4 - end use  
NT40 - manufacturing note qualifiers  
NT41 - garment attributes  
NT43 - operational code qualifier (N)  
NT51 - Filling Criterion for Package homogeneity (N)  
NT6 - coding system owner/issuer  
NT60 - language, codes from ISO 639-1 (subset) (N)  
NT7 - unit of measure (U)  
T1 - terms of payment  
T10 - ISO3166 - Country  
T11 - transport package type (U)  
T19 - fibre type  
T2 - Modes of payment  
T205 - type of job in knitting/clothing  
T21 - type of document  
T265 - type of job technology in knitting/clothing  
T275 - type of machine for knitting/clothing  
T29 - type of yarn package  
T3 - terms of delivery  
T30 - support of yarn package - material  
T32 - yarn reel wrapping type  
T33 - yarn outer packing  
T38 - transport conditions  
T4 - fabric piece inner packing (wrapping) 1  
T40 - type of transport means  
T41 - type of Allowance or Charge  
T421 - size system: nationality  
T422 - size system: market segment  
T423 - size system: base  
T44 - additional code type  
T46 - quantity variance reason  
T48 - garment part type  
T5 - fabric piece inner packing (wrapping) 2  
T6 - fabric piece outer packing  
T61 - duty or tax or fee type  
T62 - duty or tax or fee category

T7 - manufacturing status  
T8 - Modes of Transport  
T9 - ISO4217 - Currency



## Annex A

Representative images of the principal complex elements' structure.

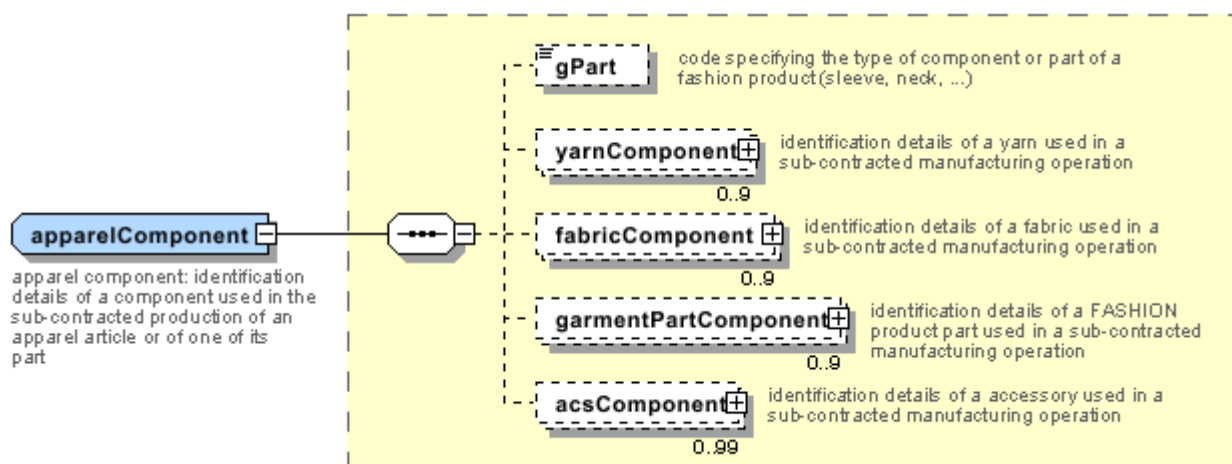
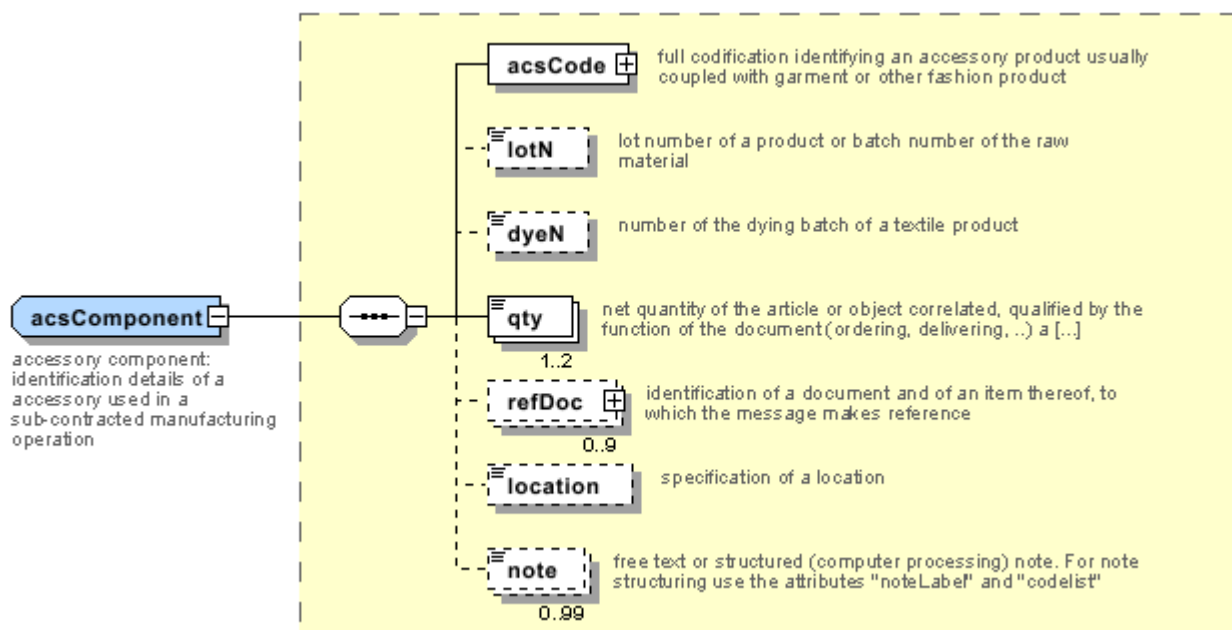

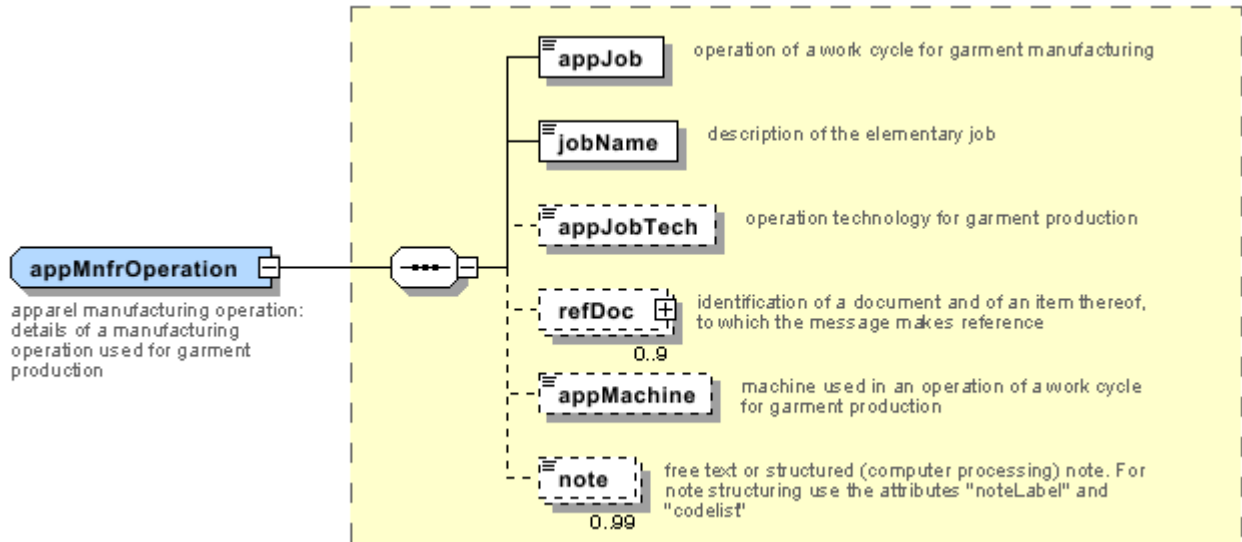
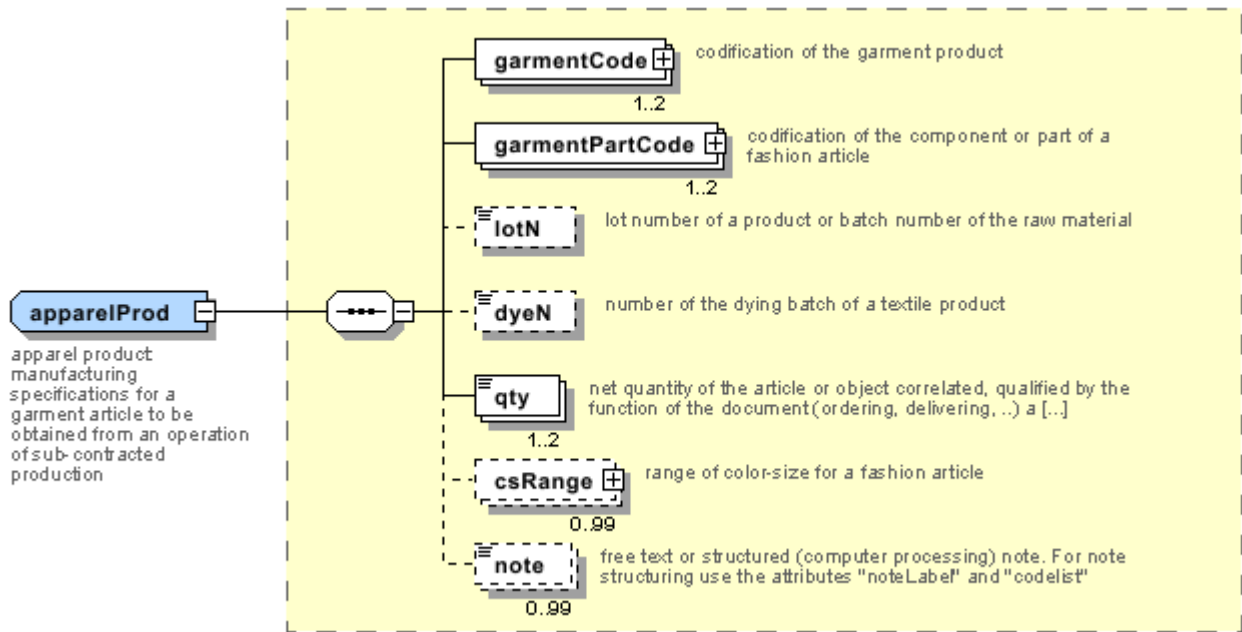

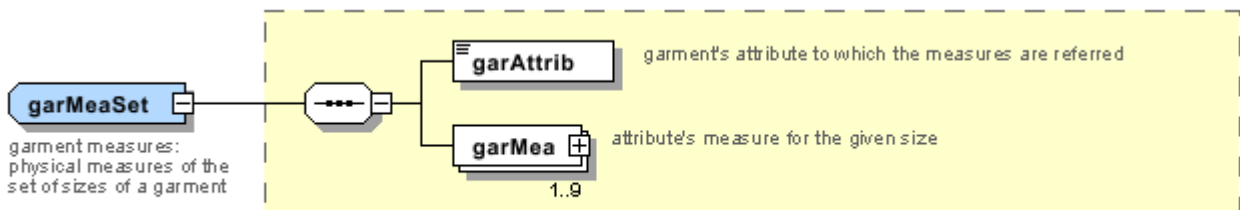
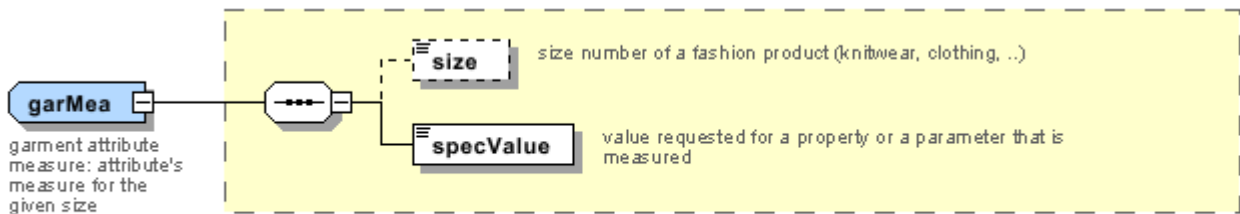
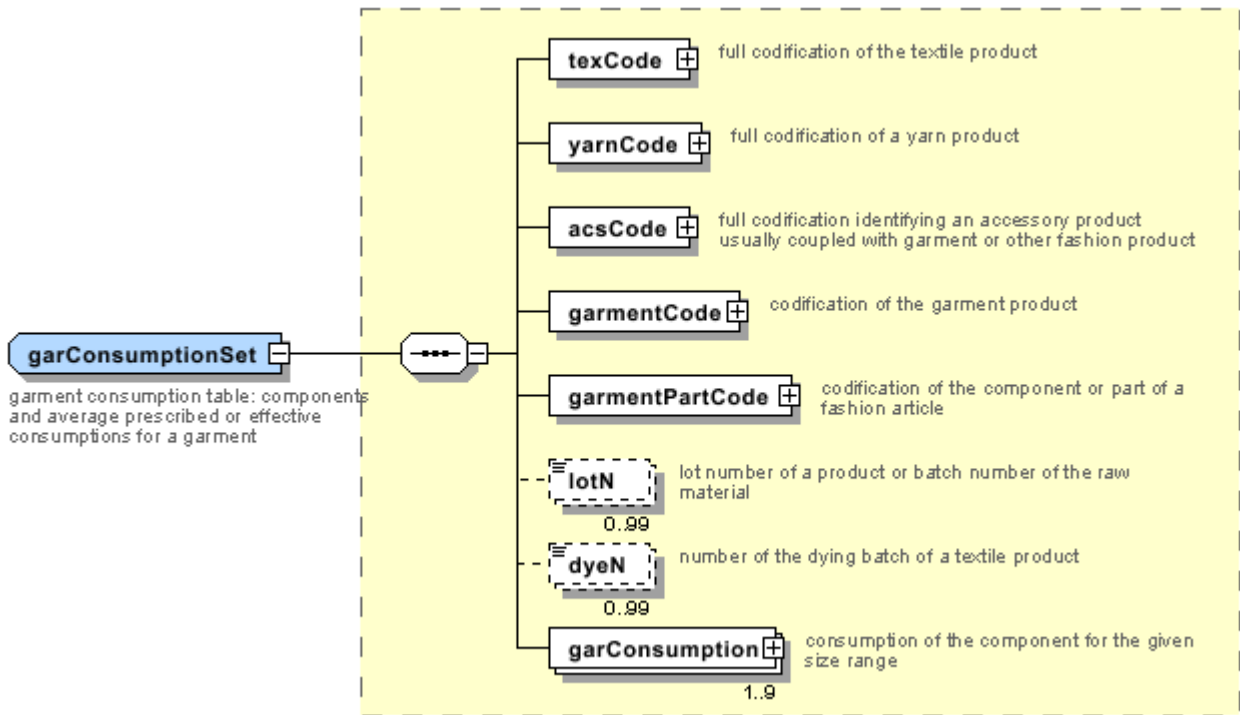



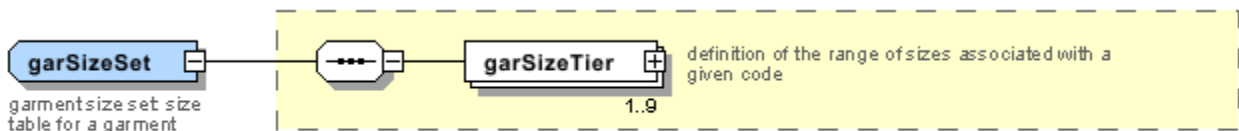
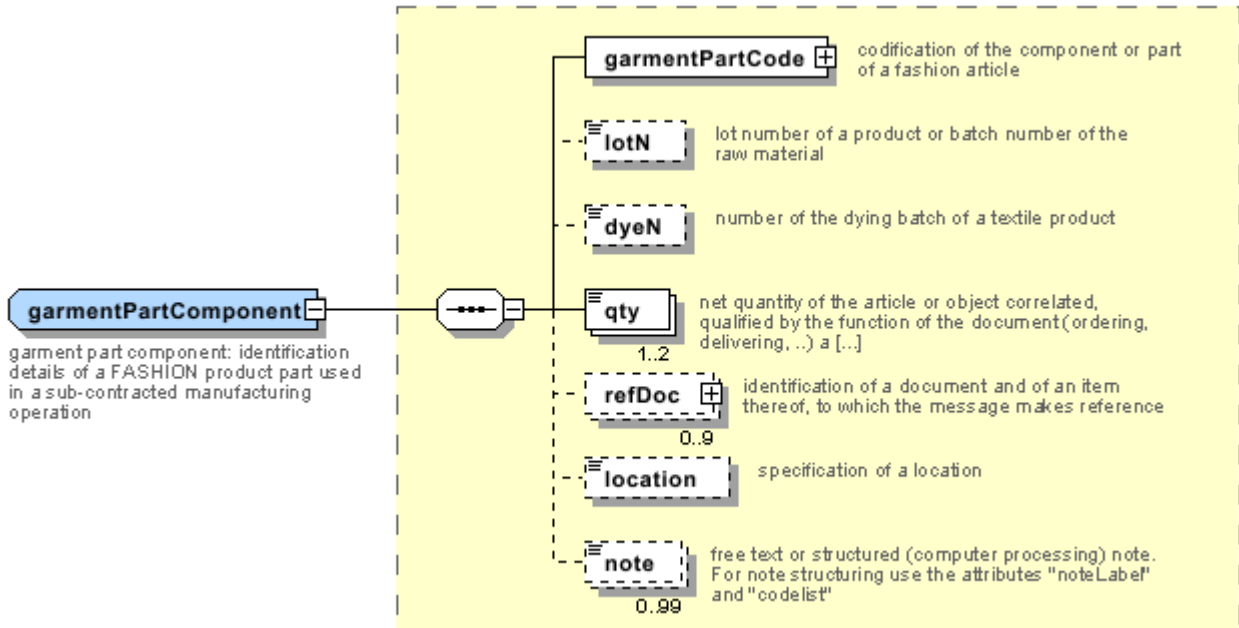
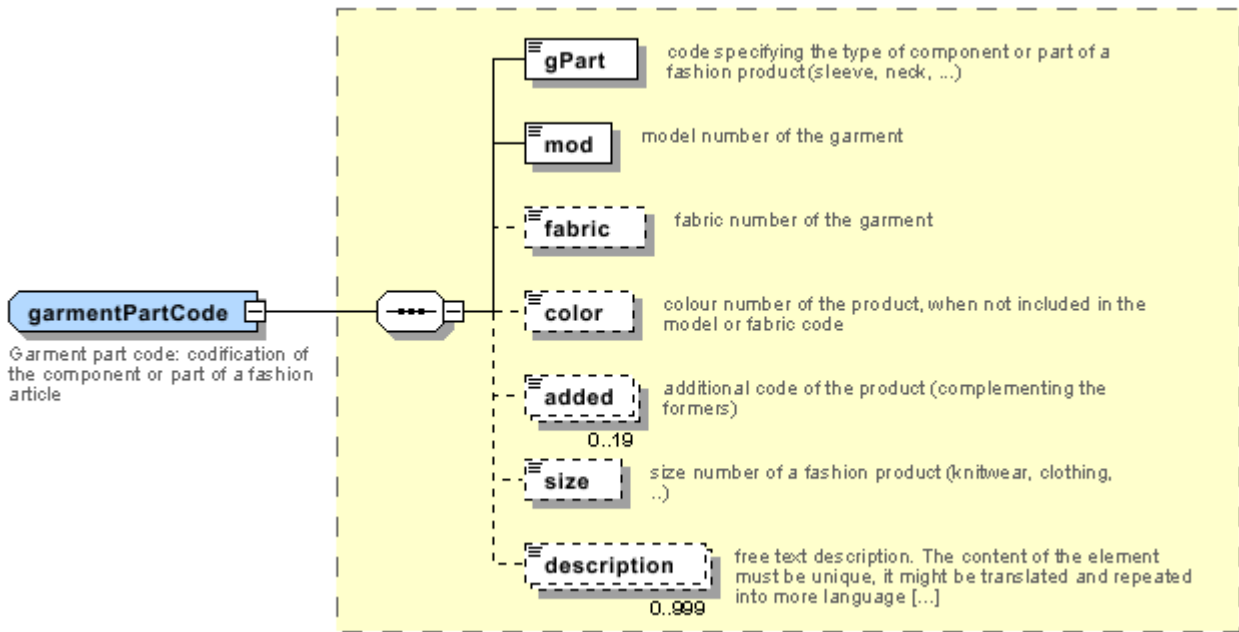

**garSizeTier**  
 garment size tier:  
 definition of the range of  
 sizes associated with a  
 given code

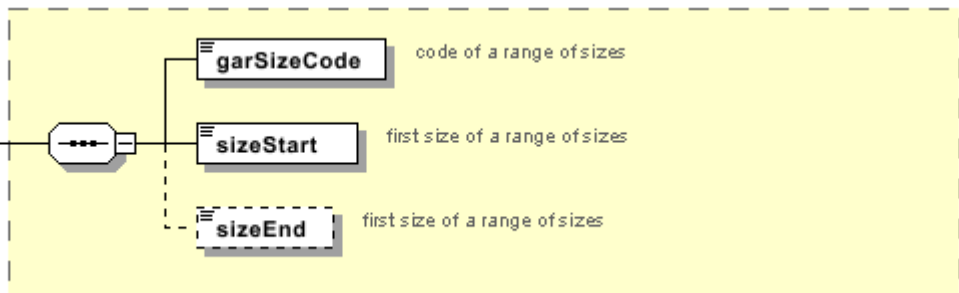

**garTecSheet**  
 garment technical sheet:  
 garment technical sheet

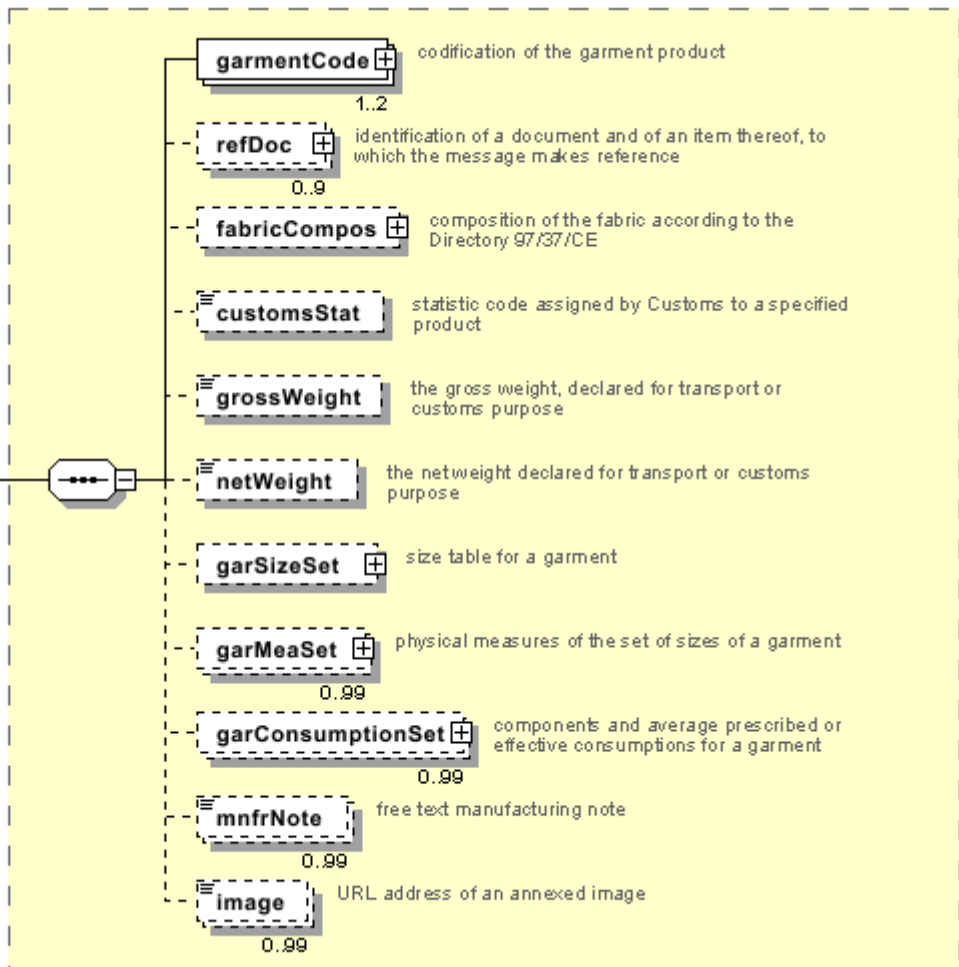

**KCCOheader**  
 KCCO header:  
 header of the  
 document FASHION  
 COMMISSION ORDER

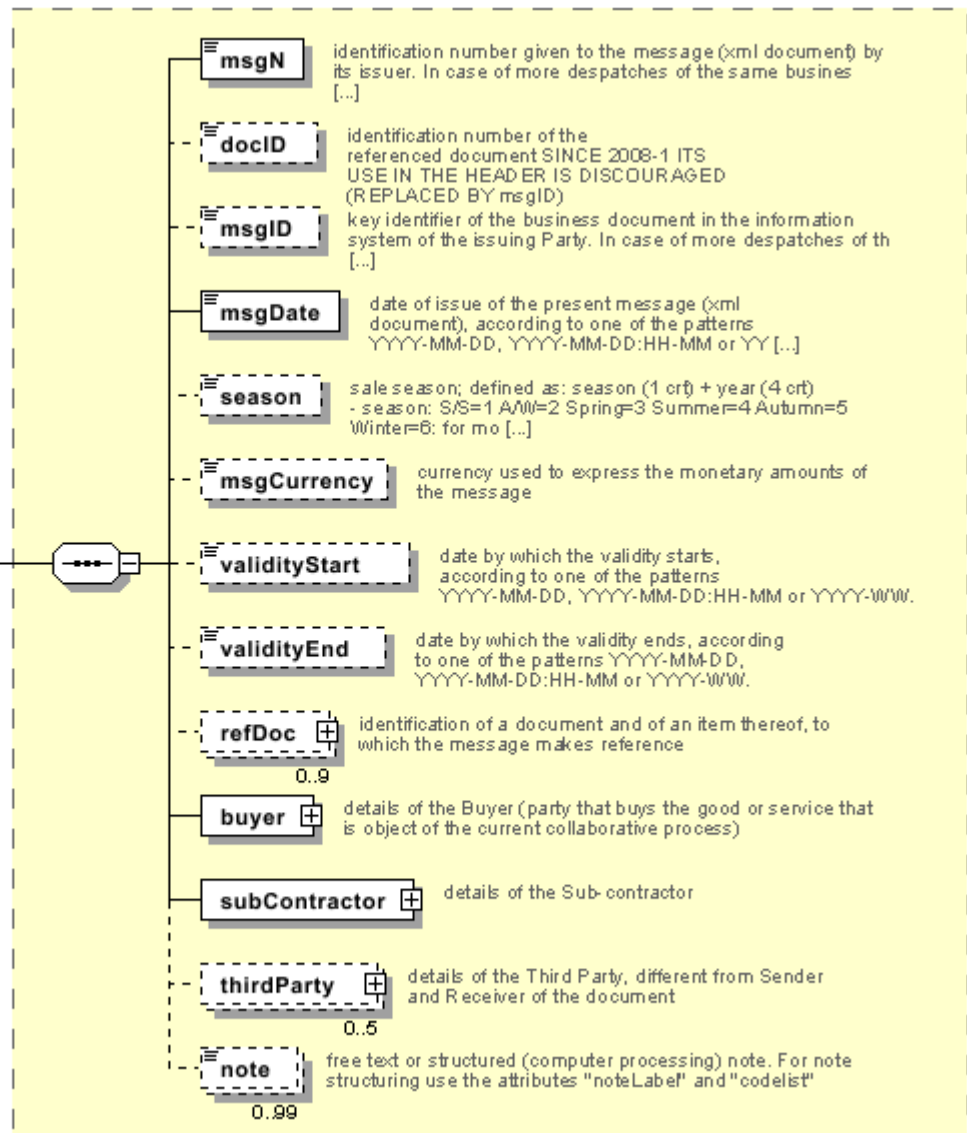

**KCCOitem**

KCCO item:  
line of the  
document  
GARMENT  
COMMISSION  
ORDER

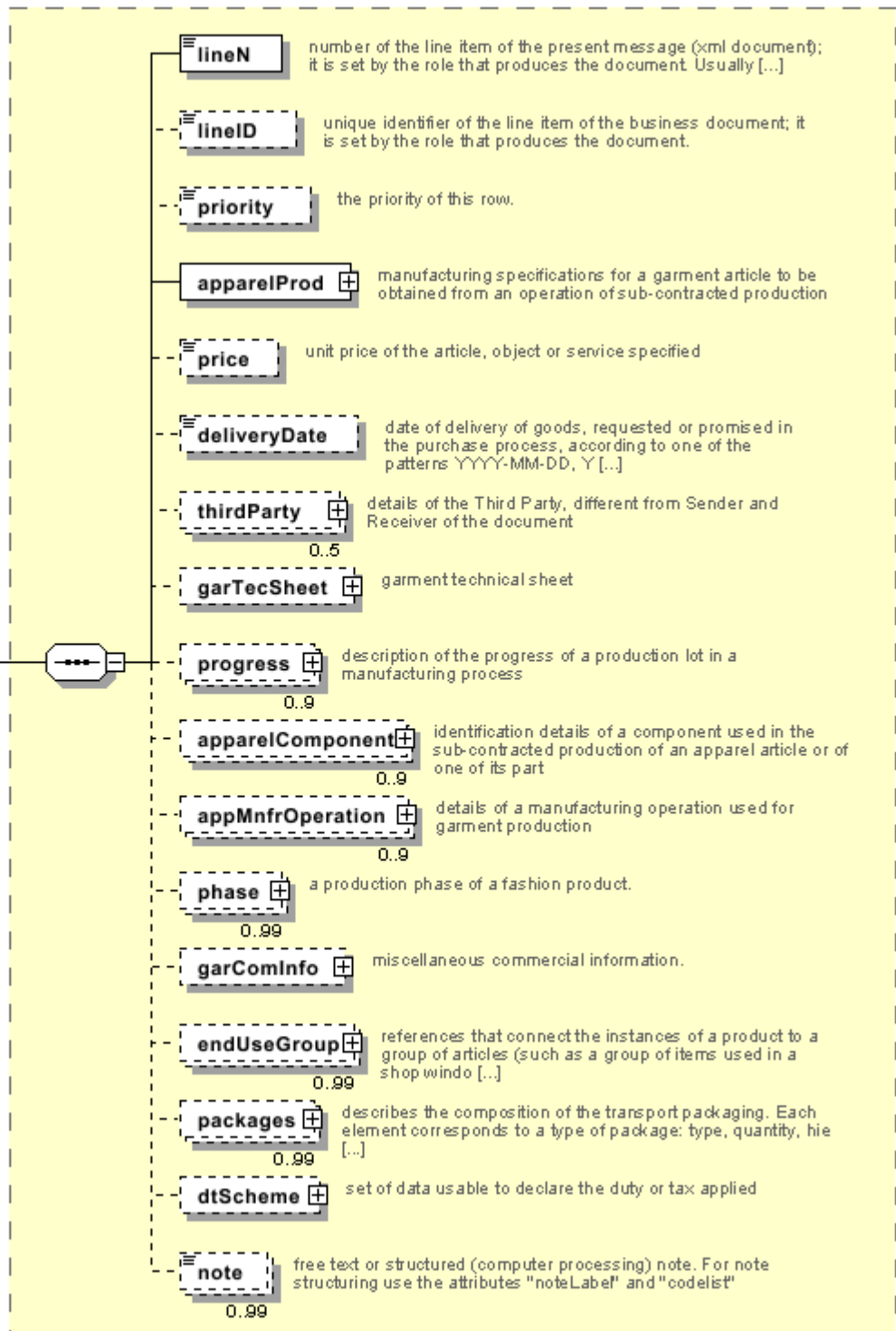

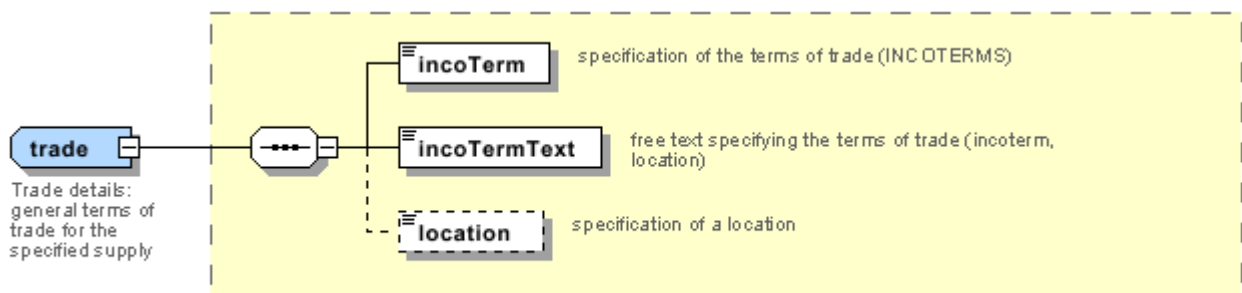
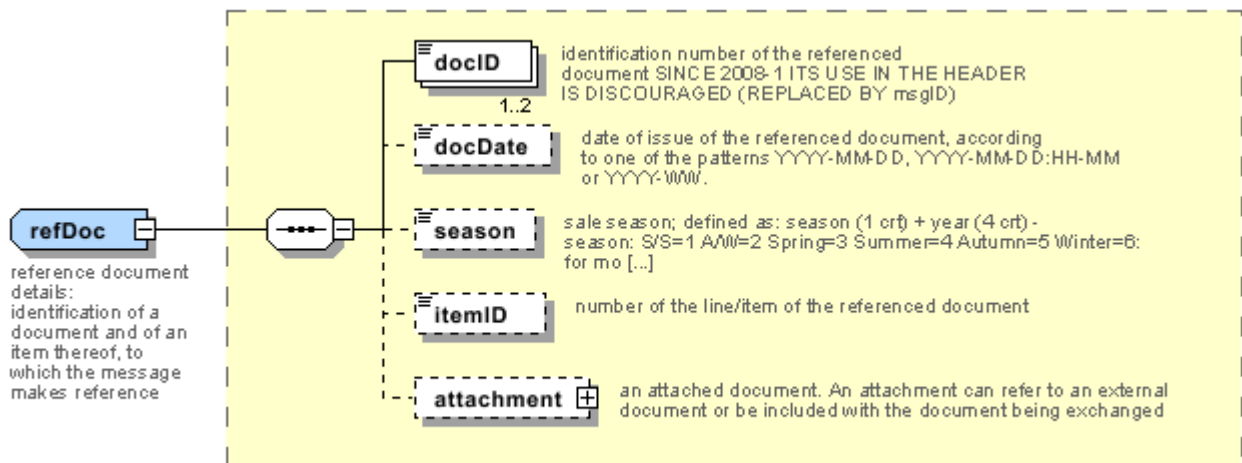
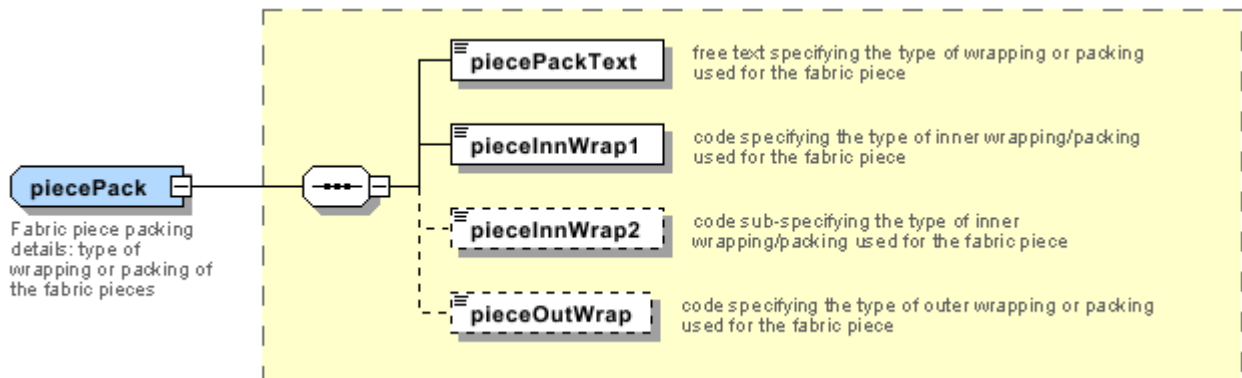
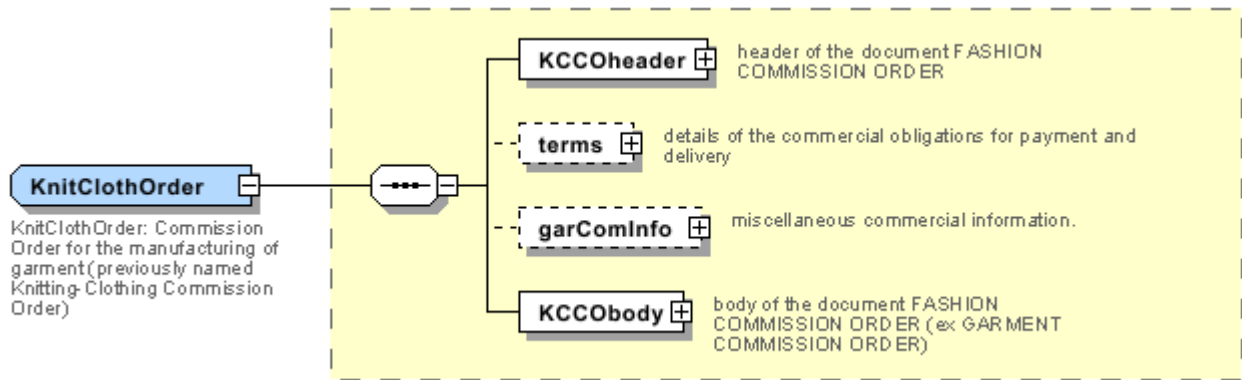

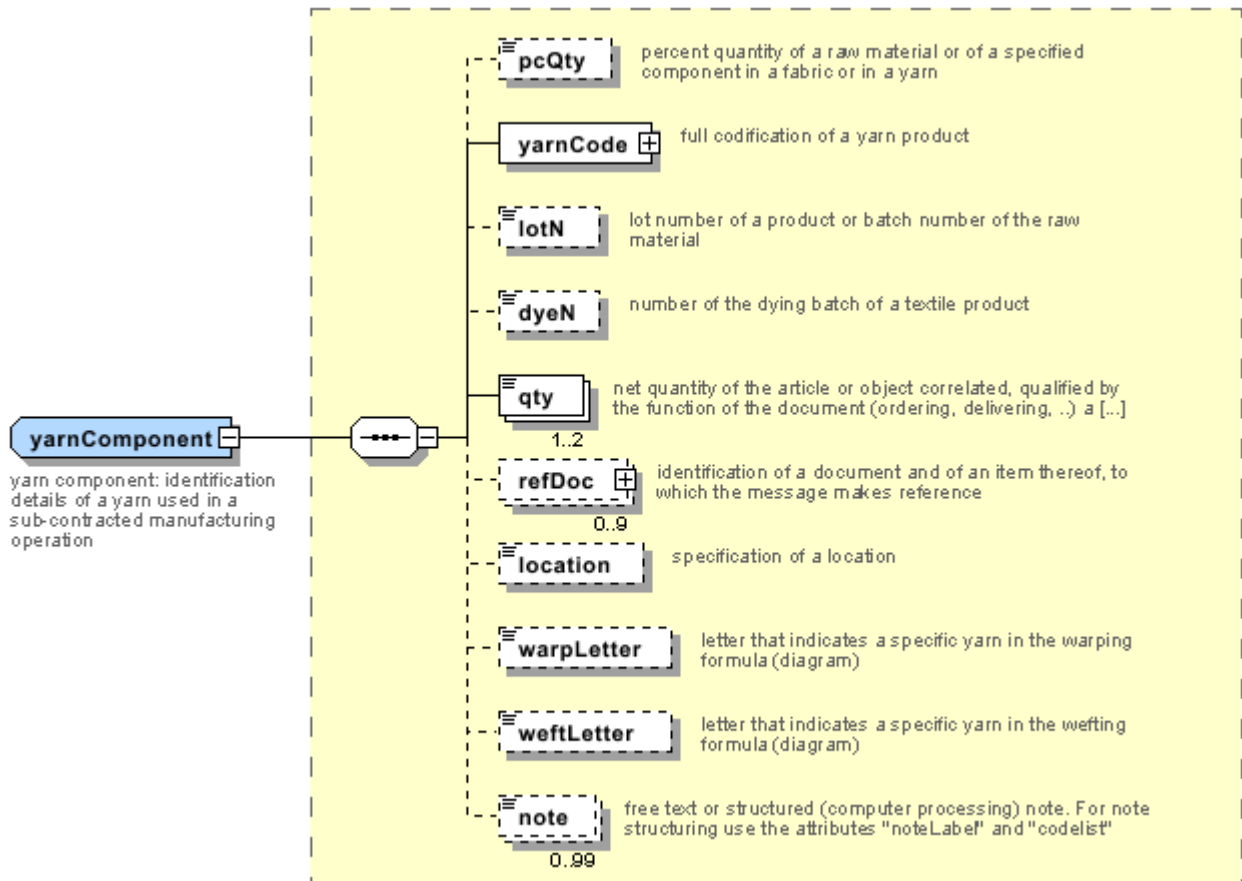





## Annex B

### NT1 - Order type

type of Order

Agency name: eBIZ

tabella cod.: NT1

File codes list (Generic code): [http://www.ebiz.enea.it/moda-ml/repository/codelist/v2018-1/gc\\_NT1.xml](http://www.ebiz.enea.it/moda-ml/repository/codelist/v2018-1/gc_NT1.xml)

Code	Description	Adoption note	Version status	Date of insertion
A	blanket	the order is open without a concrete delivery of product; it establishes an amount of goods to be produced in a future	(U)	
D	call-off	orders an amount of goods to be delivered (and invoiced and produced if necessary); it is important that it is clear that this amount should be subtracted from the amount of the blanket order referred in the refDoc element	(U)	
P	reservation			
STD	standard			

### NT100 - eBIZ TCFUpstream version

dictionary version

Agency name: eBIZ

tabella cod.: NT100

File codes list (Generic code): [http://www.ebiz.enea.it/moda-ml/repository/codelist/v2018-1/gc\\_NT100.xml](http://www.ebiz.enea.it/moda-ml/repository/codelist/v2018-1/gc_NT100.xml)

Code	Description	Adoption note	Version status	Date of insertion
2013-1	v2013-1			01/07/2013
2018-1	v2018-1		(N)	04/11/2018
draft	draft		(N)	08/09/2017

### NT11 - transport causal

reason for the transport

Agency name: eBIZ

tabella cod.: NT11

File codes list (Generic code): [http://www.ebiz.enea.it/moda-ml/repository/codelist/v2018-1/gc\\_NT11.xml](http://www.ebiz.enea.it/moda-ml/repository/codelist/v2018-1/gc_NT11.xml)

Code	Description	Adoption note	Version status	Date of insertion
FOC	free of charge			
FRW	return from re-works			
FST	return from storage			
FVW	return from view			
FWK	return from works			
IST	in storage			
NWK	return non-worked			
RJC	return from rejection			
SEL	to sell			
STO	to storage			
VEW	to view			
WRK	to works			

#### NT12 - data source

party who has provided the data

Agency name: eBIZ

tabella cod.: NT12

File codes list (Generic code): [http://www.ebiz.enea.it/moda-ml/repository/codelist/v2018-1/gc\\_NT12.xml](http://www.ebiz.enea.it/moda-ml/repository/codelist/v2018-1/gc_NT12.xml)

Code	Description	Adoption note	Version status	Date of insertion
AC	internal test			
CO	external test			
CV	test after steaming			

#### NT16 - VAT rate or code

VAT rate or code ( DEPRECATED, use dtScheme element )

tabella cod.: NT16

File codes list (Generic code): [http://www.ebiz.enea.it/moda-ml/repository/codelist/v2018-1/gc\\_NT16.xml](http://www.ebiz.enea.it/moda-ml/repository/codelist/v2018-1/gc_NT16.xml)

#### NT18 - message function

function performed by the present message with regards to the transmission

Agency name: eBIZ

tabella cod.: NT18

File codes list (Generic code): [http://www.ebiz.enea.it/moda-ml/repository/codelist/v2018-1/gc\\_NT18.xml](http://www.ebiz.enea.it/moda-ml/repository/codelist/v2018-1/gc_NT18.xml)

Code	Description	Adoption note	Version status	Date of insertion
CA	delete this document			01/07/2013
CP	copy			
OR	original			
RC	re-transmission for data correction			
RT	re-transmission			

### NT2 - third party qualifier

Third Party role qualifier

Agency name: eBIZ

tabella cod.: NT2

File codes list (Generic code): [http://www.ebiz.enea.it/moda-ml/repository/codelist/v2018-1/gc\\_NT2.xml](http://www.ebiz.enea.it/moda-ml/repository/codelist/v2018-1/gc_NT2.xml)

Code	Description	Adoption note	Version status	Date of insertion
AG	Sales Agent			
AU	Auditor		(N)	08/04/2019
CE	Certification authority		(N)	08/04/2019
CO	Quality Controller			
DC	Response to			
DF	Invoicee			
DI	Copy to (CC)			28/10/2014
DM	Consignee			
DP	Consignment address (Delivery Party)			
IM	Importer			
OR	Originator			10/09/2014
SC	Sub contractor		(N)	10/04/2019
SM	Service/ePlatform manager		(N)	08/04/2019
SP	Forwarder			
TX	Tax Representative			

### NT20 - price qualifier

type of price with reference to discount and taxes

Agency name: eBIZ

tabella cod.: NT20

File codes list (Generic code): [http://www.ebiz.enea.it/moda-ml/repository/codelist/v2018-1/gc\\_NT20.xml](http://www.ebiz.enea.it/moda-ml/repository/codelist/v2018-1/gc_NT20.xml)

Code	Description	Adoption note	Version status	Date of insertion
GET	gross excluding taxes			
GIT	gross including taxes			
NET	net excluding taxes			
NIT	net including taxes			

### NT22 - product type of an operation

level of the product (end or intermediate) yielded by an operation in a work cycle

Agency name: eBIZ

tabella cod.: NT22

File codes list (Generic code): [http://www.ebiz.enea.it/moda-ml/repository/codelist/v2018-1/gc\\_NT22.xml](http://www.ebiz.enea.it/moda-ml/repository/codelist/v2018-1/gc_NT22.xml)

Code	Description	Adoption note	Version status	Date of insertion
END	end-product			
INT	intermediate			

### NT29 - format of a date

format used for the date

Agency name: eBIZ

tabella cod.: NT29

File codes list (Generic code): [http://www.ebiz.enea.it/moda-ml/repository/codelist/v2018-1/gc\\_NT29.xml](http://www.ebiz.enea.it/moda-ml/repository/codelist/v2018-1/gc_NT29.xml)

Code	Description	Adoption note	Version status	Date of insertion
D	YYYY-MM-DD			
M	YYYY-MM-DD:HH-MM			
W	YYYY-WW			

### NT3 - data format

format of a string according to a customized User rule (local rule)

Agency name: eBIZ

tabella cod.: NT3

File codes list (Generic code): [http://www.ebiz.enea.it/moda-ml/repository/codelist/v2018-1/gc\\_NT3.xml](http://www.ebiz.enea.it/moda-ml/repository/codelist/v2018-1/gc_NT3.xml)

Code	Description	Adoption note	Version status	Date of insertion
EN4	GS1-GLN			01/07/2013
MD	mutually agreed			

### NT37 - committed quantity qualifier

specifies if the committed quantity can or can not include the loss in weight

Agency name: eBIZ

tabella cod.: NT37

File codes list (Generic code): [http://www.ebiz.enea.it/moda-ml/repository/codelist/v2018-1/gc\\_NT37.xml](http://www.ebiz.enea.it/moda-ml/repository/codelist/v2018-1/gc_NT37.xml)

Code	Description	Adoption note	Version status	Date of insertion
NS	quantity can include losses			
SA	quantity can not include losses			

### NT39 - consumption type (N)

indicates what the indicated consumption quantity is referred to

Agency name: eBIZ

tabella cod.: NT39

File codes list (Generic code): [http://www.ebiz.enea.it/moda-ml/repository/codelist/v2018-1/gc\\_NT39.xml](http://www.ebiz.enea.it/moda-ml/repository/codelist/v2018-1/gc_NT39.xml)

Code	Description	Adoption note	Version status	Date of insertion
BOL	required quantity to obtain the indicated total amount of product (Bill of Loading)		(N)	25/07/2018
BO M	required quantity for unit of product (Bill of material)		(N)	25/07/2018

#### NT4 - end use

specifies the final use of the product

Agency name: eBIZ

tabella cod.: NT4

File codes list (Generic code): [http://www.ebiz.enea.it/moda-ml/repository/codelist/v2018-1/gc\\_NT4.xml](http://www.ebiz.enea.it/moda-ml/repository/codelist/v2018-1/gc_NT4.xml)

Code	Description	Adoption note	Version status	Date of insertion
PC	test piece			
PR	production			
SA	Sample		(N)	10/09/2014
SC	samples card			
TI	patch			
TP	(test cut)			

#### NT40 - manufacturing note qualifiers

qualifier of the product treated in the note

Agency name: eBIZ

tabella cod.: NT40

File codes list (Generic code): [http://www.ebiz.enea.it/moda-ml/repository/codelist/v2018-1/gc\\_NT40.xml](http://www.ebiz.enea.it/moda-ml/repository/codelist/v2018-1/gc_NT40.xml)

Code	Description	Adoption note	Version status	Date of insertion
AD	adhesives		(D)	
BT	buttons		(D)	
CU	seams		(D)	
IB	packing		(D)	
LA	washing		(D)	
ST	ironing		(D)	

#### NT41 - garment attributes

garment's attribute to which the measures are referred

Agency name: eBIZ



tabella cod.: NT41

File codes list (Generic code): [http://www.ebiz.enea.it/moda-ml/repository/codelist/v2018-1/gc\\_NT41.xml](http://www.ebiz.enea.it/moda-ml/repository/codelist/v2018-1/gc_NT41.xml)

Code	Description	Adoption note	Version status	Date of insertion
C	neck center sleeve length		(U)	
CL	neck		(U)	
CV	crotch		(U)	
E	under-sleeve length		(U)	
F	raglan in front		(U)	
FC	hips		(U)	
G	muscle		(U)	
GM	sleeve ride		(U)	
H	bottom edge height		(U)	
I	cuff height		(U)	
L	neck edge height		(U)	
LG	width		(U)	
LM	sleeve length		(U)	
LN	length		(U)	
M	neck opening		(U)	
N	coppino		(U)	
O	sleeve width to 10 cm		(U)	
P	bottom width		(U)	
SP	shoulders		(U)	
VT	waist		(U)	

#### NT43 - operational code qualifier (N)

Agency name: eBIZ

tabella cod.: NT43

File codes list (Generic code): [http://www.ebiz.enea.it/moda-ml/repository/codelist/v2018-1/gc\\_NT43.xml](http://www.ebiz.enea.it/moda-ml/repository/codelist/v2018-1/gc_NT43.xml)

Code	Description	Adoption note	Version status	Date of insertion
1	event		(N)	08/09/2017
2	sales channel		(N)	08/09/2017
3	goods management type		(N)	08/09/2017
4	special initiative		(N)	08/09/2017

**NT51 - Filling Criterion for Package homogeneity (N)**

Filling Criterion for Package homogeneity

Agency name: eBIZ

tabella cod.: NT51

File codes list (Generic code): [http://www.ebiz.enea.it/moda-ml/repository/codelist/v2018-1/gc\\_NT51.xml](http://www.ebiz.enea.it/moda-ml/repository/codelist/v2018-1/gc_NT51.xml)

Code	Description	Adoption note	Version status	Date of insertion
COL	Colour		(N)	08/09/2017
MOD	Model		(N)	08/09/2017
SIZ	Size		(N)	08/09/2017

**NT6 - coding system owner/issuer**

code specifying the organisation who has created or owns the coding or numbering system

Agency name: eBIZ

tabella cod.: NT6

File codes list (Generic code): [http://www.ebiz.enea.it/moda-ml/repository/codelist/v2018-1/gc\\_NT6.xml](http://www.ebiz.enea.it/moda-ml/repository/codelist/v2018-1/gc_NT6.xml)

Code	Description	Adoption note	Version status	Date of insertion
CL	Customer/buyer			
CO	Quality Controller			
EB	eBIZ	replaces 'ML'	(N)	18/03/2019
EN	GS1 ( ex-EAN International )			
ES	e-Stockflow			
FO	Supplier			
GS	GS1			01/07/2013
MF	VAT identifier		(U)	
ML	Moda-ML	DEPRECATED	(U)	
SP	Service Provider			

**NT60 - language, codes from ISO 639-1 (subset) (N)**

Agency name: eBIZ / ISO

tabella cod.: NT60

File codes list (Generic code): [http://www.ebiz.enea.it/moda-ml/repository/codelist/v2018-1/gc\\_NT60.xml](http://www.ebiz.enea.it/moda-ml/repository/codelist/v2018-1/gc_NT60.xml)

Code	Description	Adoption note	Version status	Date of insertion
af	Afrikaans		(N)	31/01/2019
ar	Arabic		(N)	31/01/2019
be	Belarusian		(N)	31/01/2019
bg	Bulgarian		(N)	31/01/2019
bn	Bengali		(N)	31/01/2019
bo	Tibetan		(N)	31/01/2019
bs	Bosnian		(N)	31/01/2019
ca	Catalan, Valencian		(N)	31/01/2019
cs	Czech		(N)	31/01/2019
da	Danish		(N)	31/01/2019
de	German		(N)	31/01/2019
el	Greek, Modern (1453-)		(N)	31/01/2019
en	English		(N)	31/01/2019
eo	Esperanto		(N)	31/01/2019
es	Spanish, Castilian		(N)	31/01/2019
et	Estonian		(N)	31/01/2019
eu	Basque		(N)	31/01/2019
F	Female		(N)	15/04/2019
fa	Persian		(N)	31/01/2019
fi	Finnish		(N)	31/01/2019
fr	French		(N)	31/01/2019
ga	Irish		(N)	31/01/2019
gd	Gaelic, Scottish Gaelic		(N)	31/01/2019
gn	Guarani		(N)	31/01/2019
he	Hebrew		(N)	31/01/2019
hr	Croatian		(N)	31/01/2019
ht	Haitian, Haitian Creole		(N)	31/01/2019
hu	Hungarian		(N)	31/01/2019
hy	Armenian		(N)	31/01/2019
ia	Interlingua (International Auxiliary Language Association)		(N)	31/01/2019
id	Indonesian		(N)	31/01/2019
is	Icelandic		(N)	31/01/2019

it	Italian		(N)	31/01/2019
ja	Japanese		(N)	31/01/2019
jv	Javanese		(N)	31/01/2019
ka	Georgian		(N)	31/01/2019
km	Central Khmer		(N)	31/01/2019
ko	Korean		(N)	31/01/2019
ku	Kurdish		(N)	31/01/2019
lb	Luxembourgish, Letzeburgesch		(N)	31/01/2019
lo	Lao		(N)	31/01/2019
lt	Lithuanian		(N)	31/01/2019
lv	Latvian		(N)	31/01/2019
mg	Malagasy		(N)	31/01/2019
mk	Macedonian		(N)	31/01/2019
mn	Mongolian		(N)	31/01/2019
mt	Maltese		(N)	31/01/2019
nl	Dutch, Flemish		(N)	31/01/2019
no	Norwegian		(N)	31/01/2019
pl	Polish		(N)	31/01/2019
pt	Portuguese		(N)	31/01/2019
ro	Romanian, Moldavian, Moldovan		(N)	31/01/2019
ru	Russian		(N)	31/01/2019
se	Northern Sami		(N)	31/01/2019
sk	Slovak		(N)	31/01/2019
sl	Slovenian		(N)	31/01/2019
sm	Samoan		(N)	31/01/2019
so	Somali		(N)	31/01/2019
sq	Albanian		(N)	31/01/2019
sr	Serbian		(N)	31/01/2019
sv	Swedish		(N)	31/01/2019
sw	Swahili		(N)	31/01/2019
ta	Tamil		(N)	31/01/2019
th	Thai		(N)	31/01/2019
tr	Turkish		(N)	31/01/2019
uk	Ukrainian		(N)	31/01/2019
ur	Urdu		(N)	31/01/2019

uz	Uzbek		(N)	31/01/2019
vi	Vietnamese		(N)	31/01/2019
zh	Chinese		(N)	31/01/2019

### NT7 - unit of measure (U)

specification of the unit of measure, it is a sub set of table Unit of Measure Code - UN/ECE REC 20 delivered by United Nations Economic Commission for Europe (UN/ECE)

Agency name: eBIZ / UN/ECE

tabella cod.: NT7

File codes list (Generic code): [http://www.ebiz.enea.it/moda-ml/repository/codelist/v2018-1/gc\\_NT7.xml](http://www.ebiz.enea.it/moda-ml/repository/codelist/v2018-1/gc_NT7.xml)

Other link: <http://docs.oasis-open.org/ubl/os-UBL-2.1/cl/gc/default/UnitOfMeasureCode-2.1.gc#>

Code	Description	Adoption note	Version status	Date of insertion
CMK	square centimetre		(N)	20/12/2017
CMQ	cubic centimetre		(N)	20/12/2017
CMT	centimetre			
CNE	centiNewton			
CO2TON	ton of CO2		(N)	10/09/2014
COUPLES	couples			
DMQ	cubic decimetre			
E37	pixel		(N)	11/04/2018
GRM	gram			
HUR	hour			
INH	inch			
KGM	kilogram			
KMT	kilometer			
KWH	kilowatthours		(N)	10/09/2014
LBR	pound			
MIN	minute			
MMK	square millimetre		(N)	20/12/2017
MTK	square metre		(N)	20/12/2017
MTQ	cubic metre			
MTR	metre			
NMB	numero			
ONZ	ounce			

P1	percent			
PPM	parts per million			
PZ	piece		(U)	
RPM	rounds per metre			
YRD	yard			

## T1 - terms of payment

code specifying the terms or time by which the payment must be done

Agency name: eBIZ

tabella cod.: T1

File codes list (Generic code): [http://www.ebiz.enea.it/moda-ml/repository/codelist/v2018-1/gc\\_T1.xml](http://www.ebiz.enea.it/moda-ml/repository/codelist/v2018-1/gc_T1.xml)

Code	Description	Adoption note	Version status	Date of insertion
ANTICIP	PAYMENT IN ADVANCE			
BLCOLLECT/120D	BILL OF LADING 120 DD			
BLCOLLECT/30D	BILL OF LADING 30 DD			
BLCOLLECT/60D	BILL OF LADING 60 DD			
BLCOLLECT/90D	BILL OF LADING 90 DD			
CASH	PAYMENT ON DELIVERY			
CASHINV	PAYMENT ON RECEIPT OF INVOICE			
CREDOC/0D	DOCUMENTARY CREDIT FOR PAYM. AT SIGHT			
CREDOC/120	DOCUMENTARY CREDIT FOR PAYM. AT 120 DD			
CREDOC/150	DOCUMENTARY CREDIT FOR PAYM. AT 150 DD			
CREDOC/180	DOCUMENTARY CREDIT FOR PAYM. AT 180 DD			
CREDOC/30D	DOCUMENTARY CREDIT FOR PAYM. AT 30 DD			
CREDOC/45D	DOCUMENTARY CREDIT FOR PAYM. AT 45 DD			
CREDOC/60	DOCUMENTARY CREDIT FOR PAYM. AT 60 DD			
CREDOC/90	DOCUMENTARY CREDIT FOR PAYM. AT 90 DD			
DEL/10	PAYMENT AT 10 DD AFTER DELIVERY			
DOCOLLECT/120D	DOCUMENTARY COLLECTION AT 120 DD			
DOCOLLECT/30D	DOCUMENTARY COLLECTION AT 30 DD			
DOCOLLECT/60D	DOCUMENTARY COLLECTION AT 60 DD			

DOCOLLECT/90D	DOCUMENTARY COLLECTION AT 90 DD			
INV/120D	PAYMENT AT 120 DD AFTER RECEIPT OF INVOICE			
INV/150D	PAYMENT AT 150 DD AFTER RECEIPT OF INVOICE			
INV/180D	PAYMENT AT 180 DD AFTER RECEIPT OF INVOICE			
INV/30D	PAYMENT AT 30 DD AFTER RECEIPT OF INVOICE			
INV/45D	PAYMENT AT 45 DD AFTER RECEIPT OF INVOICE			
INV/60D	PAYMENT AT 60 DD AFTER RECEIPT OF INVOICE			
INV/90D	PAYMENT AT 90 DD AFTER RECEIPT OF INVOICE			
INVULTIMO	PAYMENT AT END MONTH RECEIPT INVOICE			
INVULTIMO/10D	PAYMENT 10 DD AFTER END MONTH RECEIPT INVOICE			
INVULTIMO/120D	PAYMENT 120 DD AFTER END MONTH RECEIPT INVOICE			
INVULTIMO/150D	PAYMENT 150 DD AFTER END MONTH RECEIPT INVOICE			
INVULTIMO/180D	PAYMENT 180 DD AFTER END MONTH RECEIPT INVOICE			
INVULTIMO/240D	PAYMENT 240 DD AFTER END MONTH RECEIPT INVOICE			
INVULTIMO/30D	PAYMENT 30 DD AFTER END MONTH RECEIPT INVOICE			
INVULTIMO/45D	PAYMENT 45 DD AFTER END MONTH RECEIPT INVOICE			
INVULTIMO/60D	PAYMENT 60 DD AFTER END MONTH RECEIPT INVOICE			
INVULTIMO/90D	PAYMENT 90 DD AFTER END MONTH RECEIPT INVOICE			
NOPAY	WITHOUT PAYMENT			
RECREDOC/0D	IRREVOC. DOCUMENTARY CREDIT FOR PAYM. AT SIGHT			
RECREDOC/120D	IRREVOC. DOCUMENTARY CREDIT FOR PAYM. AT 120 DD			
RECREDOC/150D	IRREVOC. DOCUMENTARY CREDIT FOR PAYM. AT 150 DD			
RECREDOC/180D	IRREVOC. DOCUMENTARY CREDIT FOR PAYM. AT 180 DD			
RECREDOC/30D	IRREVOC. DOCUMENTARY CREDIT FOR PAYM. AT 30 DD			
RECREDOC/45D	IRREVOC. DOCUMENTARY CREDIT FOR PAYM. AT 45 DD			



RECREDOC/60D	IRREVOC. DOCUMENTARY CREDIT FOR PAYM. AT 60 DD			
RECREDOC/90D	IRREVOC. DOCUMENTARY CREDIT FOR PAYM. AT 90 DD			
ULTIMO	PAYMENT BY END MONTH OF DELIVERY			
ULTIMO/10	PAYMENT AT 10 DD AFTER END MONTH OF DELIVERY			

### T10 - ISO3166 - Country

code of the nation

Agency name: ISO

tabella cod.: T10

File codes list (Generic code): [http://www.ebiz.enea.it/moda-ml/repository/codelist/v2018-1/gc\\_T10.xml](http://www.ebiz.enea.it/moda-ml/repository/codelist/v2018-1/gc_T10.xml)

Table not printed: there are 239 elements, more than the maximum specified for printing: 99.

### T11 - transport package type (U)

code specifying the type of package used for transport and delivery (subset of UN/ECE 8053 and UBL TransportEquipmentTypeCode-2.1)

Agency name: eBIZ

tabella cod.: T11

File codes list (Generic code): [http://www.ebiz.enea.it/moda-ml/repository/codelist/v2018-1/gc\\_T11.xml](http://www.ebiz.enea.it/moda-ml/repository/codelist/v2018-1/gc_T11.xml)

Other link: <http://docs.oasis-open.org/ubl/os-UBL-2.1/cl/gc/default/TransportEquipmentTypeCode-2.1.gc#>

Code	Description	Adoption note	Version status	Date of insertion
4A	box, steel		(U)	
4C	box, wood		(U)	
4G	Box, fibreboard		(N)	01/08/2018
4H	Box, plastic		(N)	01/08/2018
5H	Bag, woven plastic		(N)	01/08/2018
5L	Bag, textile		(N)	01/08/2018
5M	Bag, paper		(U)	
AJ	Cone		(N)	01/08/2018
BL	Bale, compressed		(N)	01/08/2018
BN	Bale, non-compressed		(N)	01/08/2018
BX	Box		(U)	

CI	Canister		(N)	01/08/2018
CL	Coil		(N)	01/08/2018
CN	Container, not otherwise specified as transport equipment		(N)	01/08/2018
CS	Case		(N)	01/08/2018
CT	Carton		(N)	01/08/2018
EC	Bag, plastic		(N)	01/08/2018
ED	Case, with pallet base		(N)	01/08/2018
EE	Case, with pallet base, wooden		(N)	01/08/2018
EF	Case, with pallet base, cardboard		(N)	01/08/2018
EG	Case, with pallet base, plastic		(N)	01/08/2018
EH	Case, with pallet base, metal		(N)	01/08/2018
FX	Bag, flexible container		(N)	01/08/2018
HN	Hanger		(N)	01/08/2018
NE	unpacked		(U)	
NF	Unpacked or unpackaged, single unit		(N)	01/08/2018
NG	Unpacked or unpackaged, multiple units		(N)	01/08/2018
OA	Pallet, CHEP 40 cm x 60 cm		(N)	01/08/2018
OB	Pallet, CHEP 80 cm x 120 cm		(N)	01/08/2018
OC	Pallet, CHEP 100 cm x 120 cm		(N)	01/08/2018
OD	Pallet, AS 4068-1993		(N)	01/08/2018
OE	Pallet, ISO T11		(N)	01/08/2018
PE	europallet (80x120)			
PX	pallet		(U)	
QS	box, plastic, solid		(U)	
RJ	Rack, clothing hanger		(N)	01/08/2018
RL	Reel		(N)	01/08/2018
SO	Spool		(N)	01/08/2018
TU	tube		(U)	
XD	bag, plastics film		(U)	
XK	bag,paper, multi-wall, water resistant		(U)	
ZZ	Mutually defined		(N)	01/08/2018

### T19 - fibre type

type of fibre used in a textile product

Agency name: eBIZ

tabella cod.: T19

File codes list (Generic code): [http://www.ebiz.enea.it/moda-ml/repository/codelist/v2018-1/gc\\_T19.xml](http://www.ebiz.enea.it/moda-ml/repository/codelist/v2018-1/gc_T19.xml)

<b>Code</b>	<b>Description</b>	<b>Adoption note</b>	<b>Version status</b>	<b>Date of insertion</b>
AB	abaca			20/08/2018
AC	acetate			
AF	other fibres			
AG	alginic fibre			
AL	alfa			20/08/2018
CA	hemp			
CC	coir (coconut)			20/08/2018
CL	chlorofibre			
CO	cotton			
CU	cuprous			
EA	elastan			
EL	Elastodiene			20/08/2018
FL	fluorofibre			
GI	broom			20/08/2018
GL	textile glass			
HA	hair			20/08/2018
HE	henequen			20/08/2018
HL	mixed linen			
HL	cotton linen union			20/08/2018
JU	jute			
KE	kenaf			20/08/2018
KP	kapoc			20/08/2018
LI	linen			
LY	lyocell			20/08/2018
MA	modacrylic			
MD	modal			
ME	metallized			
MG	maguey			20/08/2018
PA	polyamide			
PB	polyureic			

PC	acrylic			
PE	polyethylene			
PI	paper			20/08/2018
PL	polyester			
PM	polyimide			
PP	polypropylene			
PR	proteic			
PU	polyurethane			
RA	mamie			20/08/2018
SE	silk			
SI	sisal			20/08/2018
SN	sun			20/08/2018
TA	triacetate			
TR	textile residues or unspecified composition			20/08/2018
TV	trivinyll			
VI	viscose			
VY	vinylal			
WA	angora			
WB	beaver			20/08/2018
WC	cashgora			
WG	vicuna			
WK	camel			
WL	llama			
WM	mohair			
WN	lapin			20/08/2018
WO	wool			
WP	alpaca			
WS	cashmere			
WT	Oteer			20/08/2018
WU	guanaco			
WV	virgin wool			
WY	yack			

## T2 - Modes of payment

way or means of payment

Agency name: eBIZ

tabella cod.: T2

File codes list (Generic code): [http://www.ebiz.enea.it/moda-ml/repository/codelist/v2018-1/gc\\_T2.xml](http://www.ebiz.enea.it/moda-ml/repository/codelist/v2018-1/gc_T2.xml)

Code	Description	Adoption note	Version status	Date of insertion
BB	bank transfer			
IA	collection through Agent			
IS	collection through Forwarder			
RB	bank receipt			
RD	remittance			
SW	bank SWIFT			
TR	bank draft			

### T205 - type of job in knitting/clothing

operation of a work cycle for knitting/clothing

Agency name: eBIZ

tabella cod.: T205

File codes list (Generic code): [http://www.ebiz.enea.it/moda-ml/repository/codelist/v2018-1/gc\\_T205.xml](http://www.ebiz.enea.it/moda-ml/repository/codelist/v2018-1/gc_T205.xml)

Code	Description	Adoption note	Version status	Date of insertion
10	cutting			
20	sewing			
30	manufacturing			
40	washing			
50	ironing			
60	packing			

### T21 - type of document

type or class to which the referenced document belongs

Agency name: eBIZ

tabella cod.: T21

File codes list (Generic code): [http://www.ebiz.enea.it/moda-ml/repository/codelist/v2018-1/gc\\_T21.xml](http://www.ebiz.enea.it/moda-ml/repository/codelist/v2018-1/gc_T21.xml)

Code	Description	Adoption note	Version status	Date of insertion
BOR	blanket order		(N)	01/02/2018
CAT	Price catalogue - tech sheet			
CEO	Certificate of origin		(N)	13/04/2018
CER	Certificate		(N)	13/04/2018
COC	colour card			
CRN	Credit note			08/09/2017
CTO	Checking order			01/07/2013
CTR	Contract		(U)	
CXF	CxF3 file			01/07/2013
DAD	Darn order			
DDT	ddt			
DEA	Despatch advise			
DER	Despatch request			
DR	Document Request			02/12/2014
FOR	Forecast			02/12/2014
GSO	Garment stock offer			
GSX	Garment stock offer change			
INV	Invoice			
KCC	Knitting-Clothing Commission Order			02/12/2014
KCI	Garment in Work Inventory Report			02/12/2014
M2M	Made to Measure Production Order			02/12/2014
MAS	Master marker			
MCI	Visual merchandising instruction		(N)	13/04/2018
OCH	Order change			
OFF	Offer			
ORD	Purchase order			
ORP	Order response			
OSR	order status request			
OSS	Offer status			02/12/2014
OST	Order status			
OUR	our reference			
QR	Quality Report			02/12/2014
RAI	Raw Material in Work Inventory Report			02/12/2014
RDC	Raw dyeing commission order			

RDH	Raw dyeing order change			
RDR	Raw dyeing order response			
REA	Receiving advise			
REQ	Request for Offer			
RET	Return			02/12/2014
RSC	Spinning commission order			
RSH	Spinning order change			
RSR	Spinning order response			
SCL	process sheet			
TFC	Textile dyeing-finishing commission order			
TFX	Textile Dyeing-Finishing Order Change			02/12/2014
TPC	Textile printing commission order			
TPX	Textile Printing Order Change			02/12/2014
TWI	Textile in work inventory			
VMI	visual merchandising instructions		(N)	01/02/2018
WAC	Warping commission order			
WEC	Weaving commission order			
YDC	Yarn dyeing commission order			
YDH	Yarn dyeing order change			
YDR	Yarn dyeing order response			
YTC	Twisting commission order			
YWI	Yarn in work inventory			

### T265 - type of job technology in knitting/clothing

operation technology for knitting/clothing

Agency name: eBIZ

tabella cod.: T265

File codes list (Generic code): [http://www.ebiz.enea.it/moda-ml/repository/codelist/v2018-1/gc\\_T265.xml](http://www.ebiz.enea.it/moda-ml/repository/codelist/v2018-1/gc_T265.xml)

Code	Description	Adoption note	Version status	Date of insertion
00	to be developed			

### T275 - type of machine for knitting/clothing

machine used in an operation of a work cycle for knitting/clothing



Agency name: eBIZ

tabella cod.: T275

File codes list (Generic code): [http://www.ebiz.enea.it/moda-ml/repository/codelist/v2018-1/gc\\_T275.xml](http://www.ebiz.enea.it/moda-ml/repository/codelist/v2018-1/gc_T275.xml)

Code	Description	Adoption note	Version status	Date of insertion
PF	PAFF			

### T29 - type of yarn package

type of package (roll-up) used for a yarn product

Agency name: eBIZ

tabella cod.: T29

File codes list (Generic code): [http://www.ebiz.enea.it/moda-ml/repository/codelist/v2018-1/gc\\_T29.xml](http://www.ebiz.enea.it/moda-ml/repository/codelist/v2018-1/gc_T29.xml)

Code	Description	Adoption note	Version status	Date of insertion
CIL	bobbin			
CON	cone			
HNK	hank, skein			01/07/2013
MUF	muff, cake			01/07/2013
SPL	spool			
TUB	tube			
XCO	supercone			

### T3 - terms of delivery

specification of the terms of trade (INCOTERMS)

Agency name: Incoterms

tabella cod.: T3

File codes list (Generic code): [http://www.ebiz.enea.it/moda-ml/repository/codelist/v2018-1/gc\\_T3.xml](http://www.ebiz.enea.it/moda-ml/repository/codelist/v2018-1/gc_T3.xml)

Code	Description	Adoption note	Version status	Date of insertion
CFR	COST AND FREIGHT (named port of destination)			
CIF	COST, INSURANCE AND FREIGHT (named port of destination)			

CIP	CARRIAGE AND INSURANCE PAID (named place of destination)			
CP T	CARRIAGE PAID (named place of destination)			
DA F	DELIVERED AT FRONTIER (named place)	according to Incoterms® 2010 it is obsolete		08/12/2017
DA P	Delivered at Place of destination (named place of destination)	according to Incoterms® 2010		08/12/2017
DA T	Delivered at Terminal (named place of destination)	according to Incoterms® 2010		08/12/2017
DD P	DELIVERED DUTY PAID (named place of destination)			
DD U	DELIVERED DUTY UNPAID (named place of destination)	according to Incoterms® 2010 it is obsolete, use DAP		08/12/2017
DE Q	DELIVERED EX-QUAY (named port of destination)	according to Incoterms® 2010 it is obsolete		08/12/2017
DE S	DELIVERED EX-SHIP (named port of destination)	according to Incoterms® 2010 it is obsolete		08/12/2017
EX W	EX WORKS (named place)			
FA S	FREE ALONGSIDE SHIP (named port of shipment)			
FC A	FREE CARRIER (named place)			
FO B	FREE ON BOARD (named port of shipment)			

### T30 - support of yarn package - material

type of material of which a package for yarn is made

Agency name: eBIZ

tabella cod.: T30

File codes list (Generic code): [http://www.ebiz.enea.it/moda-ml/repository/codelist/v2018-1/gc\\_T30.xml](http://www.ebiz.enea.it/moda-ml/repository/codelist/v2018-1/gc_T30.xml)

Code	Description	Adoption note	Version status	Date of insertion
CA	cartoon			
DY	for soft package dyeing			
MT	metallic			01/07/2013
PL	plastic			

### T32 - yarn reel wrapping type

type of wrapping in which a package of yarn is wrapped

Agency name: eBIZ

tabella cod.: T32

File codes list (Generic code): [http://www.ebiz.enea.it/moda-ml/repository/codelist/v2018-1/gc\\_T32.xml](http://www.ebiz.enea.it/moda-ml/repository/codelist/v2018-1/gc_T32.xml)

Code	Description	Adoption note	Version status	Date of insertion
XA	without bag			
XB	paper bag			01/07/2013
XD	plastic film bag			

### T33 - yarn outer packing

code specifying the type of outer wrapping or packing of a yarn

Agency name: eBIZ

tabella cod.: T33

File codes list (Generic code): [http://www.ebiz.enea.it/moda-ml/repository/codelist/v2018-1/gc\\_T33.xml](http://www.ebiz.enea.it/moda-ml/repository/codelist/v2018-1/gc_T33.xml)

Code	Description	Adoption note	Version status	Date of insertion
00				
CB	cartoon box			
CC	cartoon box 18 reels			
CD	cartoon box 36 reels			
XD	plastic film			

### T38 - transport conditions

special condition of transport or special service requested to the Forwarder

tabella cod.: T38

File codes list (Generic code): [http://www.ebiz.enea.it/moda-ml/repository/codelist/v2018-1/gc\\_T38.xml](http://www.ebiz.enea.it/moda-ml/repository/codelist/v2018-1/gc_T38.xml)

Code	Description	Adoption note	Version status	Date of insertion
ACC	arrange customs clearance			
CAL	Carrier loads			
CAU	Carrier unloads			

CMR	CMR carnet			
FFN	freight forwarders national conditions			
FLD	special agreement for full loading			
NCC	do not arrange customs clearance			
PPB	packaging paid by Buyer			
PPS	packaging paid by Supplier			
PRO	proof of delivery			
RFR	return container free			
RPC	return container paid by Customer			
RPS	return container paid by Supplier			
SHL	Shipper loads			
SHU	Consignee unloads			

#### T4 - fabric piece inner packing (wrapping) 1

code specifying the type of inner wrapping/packing used for the fabric piece

Agency name: eBIZ

tabella cod.: T4

File codes list (Generic code): [http://www.ebiz.enea.it/moda-ml/repository/codelist/v2018-1/gc\\_T4.xml](http://www.ebiz.enea.it/moda-ml/repository/codelist/v2018-1/gc_T4.xml)

Code	Description	Adoption note	Version status	Date of insertion
A	Folded, whole width			
B	Folded, doubled			
C	Folded, tube products			
D	Spooled, whole width			
E	Spooled, doubled, pli: left			
F	Spooled, doubled, pli: right			
G	Rolled, whole width, single item			
H	Rolled, whole width, several items			
I	Rolled, doubled			
J	Rolled, tube products			

#### T40 - type of transport means

means of transport, in general or referred to a specific leg

Agency name: eBIZ

tabella cod.: T40

File codes list (Generic code): [http://www.ebiz.enea.it/moda-ml/repository/codelist/v2018-1/gc\\_T40.xml](http://www.ebiz.enea.it/moda-ml/repository/codelist/v2018-1/gc_T40.xml)

Code	Description	Adoption note	Version status	Date of insertion
AIR	aircraft			
SHP	ship			
TRU	truck			
VAN	van			

### T41 - type of Allowance or Charge

coded specification of an Allowance or Charge (elaborated from UNECE 4465)

Agency name: eBIZ

tabella cod.: T41

File codes list (Generic code): [http://www.ebiz.enea.it/moda-ml/repository/codelist/v2018-1/gc\\_T41.xml](http://www.ebiz.enea.it/moda-ml/repository/codelist/v2018-1/gc_T41.xml)

Code	Description	Adoption note	Version status	Date of insertion
1	Agreed settlement		(N)	19/08/2018
10	Costs for draft		(N)	19/08/2018
11	Bank charges	DEPRECATED, use CBK	(N)	19/08/2018
12	Agent commission		(N)	19/08/2018
14	Wrong delivery		(N)	19/08/2018
15	Goods returned to agent		(N)	19/08/2018
16	Goods partly returned		(N)	19/08/2018
17	Transport damage		(N)	19/08/2018
19	Trade discount		(N)	19/08/2018
2	Below specification goods		(N)	19/08/2018
20	Deduction for late delivery	DEPRECATED, use CWB	(N)	19/08/2018

21	Advertising costs		(N)	19/08/2018
22	Customs duties		(N)	19/08/2018
23	Telephone and postal costs		(N)	19/08/2018
24	Repair costs		(N)	19/08/2018
25	Attorney fees		(N)	19/08/2018
26	Taxes		(N)	19/08/2018
3	Damaged goods		(N)	19/08/2018
30	Direct payment to seller		(N)	19/08/2018
32	Goods not delivered		(N)	19/08/2018
33	Late delivery		(N)	19/08/2018
35	Goods returned		(N)	19/08/2018
36	Invoice not received		(N)	19/08/2018
37	Credit note to debtor/not to us		(N)	19/08/2018
38	Deducted bonus		(N)	19/08/2018
39	Deducted discount		(N)	19/08/2018
4	Short delivery		(N)	19/08/2018
40	Deducted freight costs		(N)	19/08/2018
41	Deduction against other invoices		(N)	19/08/2018
42	Credit balance(s)		(N)	19/08/2018
45	Debit note to seller		(N)	19/08/2018
46	Discount beyond terms		(N)	19/08/2018
48	Allowance/charge error		(N)	19/08/2018

49	Substitute product		(N)	19/08/2018
50	Terms of sale error		(N)	19/08/2018
52	Wrong invoice		(N)	19/08/2018
53	Duplicate invoice		(N)	19/08/2018
54	Weight error		(N)	19/08/2018
55	Additional charge not authorized		(N)	19/08/2018
56	Incorrect discount		(N)	19/08/2018
57	Price change		(N)	19/08/2018
58	Variation		(N)	19/08/2018
59	Chargeback		(N)	19/08/2018
65	Settlement to agent		(N)	19/08/2018
66	Cash discount		(N)	19/08/2018
7	Payment on account		(N)	19/08/2018
70	Wrong monetary amount resulting from incorrect free goods quantity		(N)	19/08/2018
72	Temporary special promotion		(N)	19/08/2018
73	Difference in tax rate		(N)	19/08/2018
74	Quantity discount		(N)	19/08/2018
75	Promotion discount		(N)	19/08/2018
76	Cancellation deadline passed		(N)	19/08/2018
77	Pricing discount		(N)	19/08/2018
78	Volume discount		(N)	19/08/2018
79	Sundry discount		(N)	19/08/2018



8	Returnable container charge included		(N)	19/08/2018
9	Invoice error		(N)	19/08/2018
AWA	bonus for works ahead of schedule			
CBK	bank charges			
CCR	servizio di corriere			
CIN	insurance			
CLB	labelling			
CPK	packing			
CSP	special packing			
CWB	penalty for works behind schedule			

#### T421 - size system: nationality

nation or agency identifying the size system

Agency name: eBIZ

tabella cod.: T421

File codes list (Generic code): [http://www.ebiz.enea.it/moda-ml/repository/codelist/v2018-1/gc\\_T421.xml](http://www.ebiz.enea.it/moda-ml/repository/codelist/v2018-1/gc_T421.xml)

Code	Description	Adoption note	Version status	Date of insertion
DE	Germany			
ES	Spain			
EU	Europe			
FR	France			
IT	Italy			
UK	United Kingdom			
US	USA			
XX	International			

#### T422 - size system: market segment

market segment identifying the size system

Agency name: eBIZ

tabella cod.: T422

File codes list (Generic code): [http://www.ebiz.enea.it/moda-ml/repository/codelist/v2018-1/gc\\_T422.xml](http://www.ebiz.enea.it/moda-ml/repository/codelist/v2018-1/gc_T422.xml)

Code	Description	Adoption note	Version status	Date of insertion
B	baby			
C	child			
K	kid			
M	man			
U	unisex			
W	woman			

### T423 - size system: base

base of the size system

Agency name: eBIZ

tabella cod.: T423

File codes list (Generic code): [http://www.ebiz.enea.it/moda-ml/repository/codelist/v2018-1/gc\\_T423.xml](http://www.ebiz.enea.it/moda-ml/repository/codelist/v2018-1/gc_T423.xml)

Code	Description	Adoption note	Version status	Date of insertion
1	arab numbers			
2	latin numbers			
3	symbols			
4	letters			
H	height			
L	length			
U	unic			
W	weight			

### T44 - additional code type

qualifier of the additional coding of a product

Agency name: eBIZ

tabella cod.: T44

File codes list (Generic code): [http://www.ebiz.enea.it/moda-ml/repository/codelist/v2018-1/gc\\_T44.xml](http://www.ebiz.enea.it/moda-ml/repository/codelist/v2018-1/gc_T44.xml)

Code	Description	Adoption note	Version status	Date of insertion
------	-------------	---------------	----------------	-------------------

CC	colour card			
CL	sales collection			
CO	company identification code		(N)	08/09/2017
DY	dye number			
LT	lot number			
MDI	Made in			08/09/2017
MS	manufacturing state			
PKG	packaging			09/09/2014
PL	product line			
RGB	RGB value			
SE	selvedge code			

#### T46 - quantity variance reason

reason for the difference between the two quantities specified by the context

Agency name: eBIZ

tabella cod.: T46

File codes list (Generic code): [http://www.ebiz.enea.it/moda-ml/repository/codelist/v2018-1/gc\\_T46.xml](http://www.ebiz.enea.it/moda-ml/repository/codelist/v2018-1/gc_T46.xml)

Code	Description	Adoption note	Version status	Date of insertion
DAM	damaged on receipt			
DIF	different article			
NAC	not acceptable for quality or conformance			
NRC	not received			

#### T48 - garment part type

code specifying the type of component or part of a garment (sleeve, neck, ...)

Agency name: eBIZ

tabella cod.: T48

File codes list (Generic code): [http://www.ebiz.enea.it/moda-ml/repository/codelist/v2018-1/gc\\_T48.xml](http://www.ebiz.enea.it/moda-ml/repository/codelist/v2018-1/gc_T48.xml)

Code	Description	Adoption note	Version status	Date of insertion
BB	bottom back		(N)	01/08/2018
BF	bottom fore/front		(N)	01/08/2018
CO	collar		(N)	01/08/2018

CU	cuff		(N)	01/08/2018
DV	fore		(N)	
EM	embroidery		(N)	01/08/2018
OC	other component		(N)	01/08/2018
PO	pocket		(N)	01/08/2018
SC	back		(N)	
SL	sleeve		(N)	01/08/2018
TB	top back		(N)	01/08/2018
TF	top fore/front		(N)	01/08/2018

### T5 - fabric piece inner packing (wrapping) 2

code specifying the sub-type of inner wrapping/packing used for the fabric piece

Agency name: eBIZ

tabella cod.: T5

File codes list (Generic code): [http://www.ebiz.enea.it/moda-ml/repository/codelist/v2018-1/gc\\_T5.xml](http://www.ebiz.enea.it/moda-ml/repository/codelist/v2018-1/gc_T5.xml)

Code	Description	Adoption note	Version status	Date of insertion
A	Open			
B	Folded once, not looped			
C	Folded twice, not looped			
H	Folded once, looped			
I	Folded twice, looped			
J	Without inner object, right side inside			
K	On carton or spooling plank, right side inside			
L	On spool (for pressure sensitive products), right side inside			
M	Without inner object, left side inside			
N	On carton or spooling plank, left side inside			
O	On spool (for pressure sensitive products), left side inside			
P	Without inner object, right side inside (deprecated code)			
Q	On carton, right side inside			
R	On wooden stick, right side inside			
S	Without inner object, left side inside (deprecated code)			
T	On carton, left side inside			
U	On wooden stick, left side inside			

### T6 - fabric piece outer packing

code specifying the type of outer wrapping or packing used for the fabric piece

Agency name: eBIZ

tabella cod.: T6

File codes list (Generic code): [http://www.ebiz.enea.it/moda-ml/repository/codelist/v2018-1/gc\\_T6.xml](http://www.ebiz.enea.it/moda-ml/repository/codelist/v2018-1/gc_T6.xml)

Code	Description	Adoption note	Version status	Date of insertion
0	Not wrapped			
1	Totally wrapped			
2	Wrapped, one side open			
3	Wrapped, both sides open			
4	Wrapped, one side open, with show corner			
5	Wrapped in cartons			
6	Double wrapped			

### T61 - duty or tax or fee type

duty or tax or fee type

Agency name: eBIZ

tabella cod.: T61

File codes list (Generic code): [http://www.ebiz.enea.it/moda-ml/repository/codelist/v2018-1/gc\\_T61.xml](http://www.ebiz.enea.it/moda-ml/repository/codelist/v2018-1/gc_T61.xml)

Code	Description	Adoption note	Version status	Date of insertion
BOL	stamp duty			01/07/2013
CUD	customs duty			01/07/2013
ENV	environmental tax			01/07/2013
FRE	no tax			01/07/2013
OTH	other tax charges			01/07/2013
VAT	value added tax			01/07/2013

### T62 - duty or tax or fee category

duty or tax or fee category

Agency name: eBIZ

tabella cod.: T62

File codes list (Generic code): [http://www.ebiz.enea.it/moda-ml/repository/codelist/v2018-1/gc\\_T62.xml](http://www.ebiz.enea.it/moda-ml/repository/codelist/v2018-1/gc_T62.xml)

Code	Description	Adoption note	Version status	Date of insertion
AA	lower than standard rate			01/07/2013
E	tax not applicable			01/07/2013
H	higher than standard rate			01/07/2013
O	outside scope of tax			01/07/2013
S	standard rate			01/07/2013
Z	zero rate goods			01/07/2013

### T7 - manufacturing status

code of the manufacturing stage used to describe the progress in the production cycle

Agency name: eBIZ

tabella cod.: T7

File codes list (Generic code): [http://www.ebiz.enea.it/moda-ml/repository/codelist/v2018-1/gc\\_T7.xml](http://www.ebiz.enea.it/moda-ml/repository/codelist/v2018-1/gc_T7.xml)

Code	Description	Adoption note	Version status	Date of insertion
000	to be launched			
001	launched			01/07/2013
010	knitted			
020	packed			
090	preparing			01/07/2013
095	prepared			01/07/2013
100	warping			
199	warped			
200	weaving			
299	woven			
300	dyeing			
399	dyed			
400	finishing			
499	finished			
500	printing			
599	printed			
600	darning			

640	preparing for printing			01/07/2013
650	prepared for printing			01/07/2013
660	checking			01/07/2013
670	checked			01/07/2013
700	spinning			
799	spun			
800	twisting			
899	twisted			
900	despatch-ready			
950	despatched			
999	other, see note if any			01/07/2013

### T8 - Modes of Transport

way of transport, in general or referred to the specified leg

Agency name: eBIZ

tabella cod.: T8

File codes list (Generic code): [http://www.ebiz.enea.it/moda-ml/repository/codelist/v2018-1/gc\\_T8.xml](http://www.ebiz.enea.it/moda-ml/repository/codelist/v2018-1/gc_T8.xml)

Code	Description	Adoption note	Version status	Date of insertion
1	MARITIME TRANSPORT			
10	Courier			01/07/2013
2	RAIL TRANSPORT			
3	ROAD TRANSPORT			
4	AIR TRANSPORT			
5	MAIL			
6	AIR + SHIP TRANSPORT			
8	INLAND WATER TRANSPORT			
9	MODE UNKNOWN			

### T9 - ISO4217 - Currency

currency code

Agency name: ISO



tabella cod.: T9

File codes list (Generic code): [http://www.ebiz.enea.it/moda-ml/repository/codelist/v2018-1/gc\\_T9.xml](http://www.ebiz.enea.it/moda-ml/repository/codelist/v2018-1/gc_T9.xml)

Table not printed: there are 205 elements, more than the maximum specified for printing: 99.

## Annex C

### New or changed elements towards previous version

Changes or added elements (changes in description excluded; changes in aggregation notes and best practice included): 328

Test Type	Tag	Status	Item type	Changes related to
Attribute	AC_amount	NEW	AC amount	Has NEW attribute: data currency
Element(E)	AC_categoryText	UPDATED	AC category text	Property: Length_Max Old value: 70 New value: 250
Child	acsCode	UPDATED	Accessory code	relationship with child: description  Property: Cardmax Old value: 1 New value: 999
Element(E)	acsCode	UPDATED	Accessory code	Property: class Old value: <i>garment accessory</i> New value: <i>accessory</i>
Child	acsCode	UPDATED	Accessory code	relationship with child: description  Property: Aggregation Note_English Old value: New value: <i>Product description</i>
Child	acsComponent	UPDATED	accessory component	relationship with child: general note  Property: Cardmax Old value: 19 New value: 99
Child	acsComponent	UPDATED	accessory component	relationship with child: product quantity  Property: BestPractice_English Old value: New value: <i>this element can have two instances only if the units of measure are different</i>
Child	acsComponent	UPDATED	accessory component	relationship with child: reference document details  Property: Cardmax Old value: 1 New value: 9
Attribute	acsPackCode	NEW	Accessory packing code	Has NEW attribute: numbering organisation code

Attribute	acsPackCode	NEW	Accessory packing code	Has NEW attribute: code list reference
Attribute	acsPackCode	NEW	Accessory packing code	Has NEW attribute: code list name
Attribute	acsPackCode	NEW	Accessory packing code	Has NEW attribute: code list version
Element(E)	acsPackCode	UPDATE	Accessory packing code	Property: class Old value: <i>garment accessory</i> New value: <i>accessory</i>
Element(E)	acsPack	UPDATE	Accessory packing details	Property: class Old value: <i>garment accessory</i> New value: <i>accessory</i>
Element(E)	acsPackText	UPDATE	Accessory packing text	Property: Length_Max Old value: <i>40</i> New value: <i>250</i>
Element(E)	acsPackText	UPDATE	Accessory packing text	Property: class Old value: <i>garment accessory</i> New value: <i>accessory</i>
Attribute	additionalIdentifier	NEW	Additional Party Identifier	Has NEW attribute: numbering organisation code
Attribute	additionalIdentifier	NEW	Additional Party Identifier	Has NEW attribute: id Qualifier
Element(I)	additionalComponentCode	NEW	component Code	
Element(I)	additionalIdentifier	NEW	Additional Party Identifier	
Attribute	allowanceCharge	NEW	Allowance and Charge	Has NEW attribute: is Charge
Attribute	allowanceCharge	NEW	Allowance and Charge	Has NEW attribute: maximum quantity
Attribute	allowanceCharge	NEW	Allowance and Charge	Has NEW attribute: minimum quantity
Attribute	allowanceCharge	NEW	Allowance and Charge	Has NEW attribute: data currency
Attribute	allowanceCharge	NEW	Allowance and Charge	Has NEW attribute: unit of measure code
Child	apparelComponent	UPDATE	apparel component	relationship with child: garment part component  Property: Aggregation Note_English Old value: New value: <i>used only for components that are semifinished products with their own code</i>

Child	appMnfrOperation	UPDATED	apparel manufacturing operation	relationship with child: general note  Property: Cardmax Old value: 19 New value: 99
Child	appMnfrOperation	UPDATED	apparel manufacturing operation	relationship with child: reference document details  Property: Cardmax Old value: 1 New value: 9
Child	apparelProduct	UPDATED	apparel product	relationship with child: general note  Property: Cardmax Old value: 19 New value: 99
Child	apparelProduct	UPDATED	apparel product	relationship with child: product quantity  Property: BestPractice_English Old value: New value: <i>this element can have two instances only if the units of measure are different</i>
Child	apparelProduct	UPDATED	apparel product	relationship with child: Garment product identifier  Property: Aggregation Note_English Old value: New value: <i>this element can have two instances only if the numbering organisations are different</i>
Child	apparelProduct	UPDATED	apparel product	relationship with child: Garment part code  Property: Cardmax Old value: 1 New value: 2
Child	apparelProduct	UPDATED	apparel product	relationship with child: Garment part code  Property: Aggregation Note_English Old value: New value: <i>this element can have two instances only if the numbering organisations are different</i>
Element(E)	art	UPDATED	article identifier	Property: Length_Max Old value: 25 New value: 80
Attribute	art	UPDATED	article identifier	Its attribute: code list reference  Property: Aggregation Note_English Old value: <i>this attribute should be ALTERNATIVE to the others</i> New value: <i>at least one out of this attribute and "numberingOrg" should be set</i>

Element(l)	attachment	NEW	attachment	
Child	attachment	NEW	attachment	Has NEW child of: file name
Child	attachment	NEW	attachment	Has NEW child of: external reference
Child	attachment	NEW	attachment	Has NEW child of: binary object
Attribute	binaryObject	NEW	binary object	Has NEW attribute: encoding
Attribute	binaryObject	NEW	binary object	Has NEW attribute: mime
Attribute	binaryObject	NEW	binary object	Has NEW attribute: format
Attribute	binaryObject	NEW	binary object	Has NEW attribute: character set
Element(l)	binaryObject	NEW	binary object	
Attribute	brand	NEW	Brand	Has NEW attribute: code list version
Element(l)	brand	NEW	Brand	
Attribute	brand	NEW	Brand	Has NEW attribute: numbering organisation code
Attribute	brand	NEW	Brand	Has NEW attribute: code list reference
Attribute	brand	NEW	Brand	Has NEW attribute: code list name
Child	buyer	NEW	Buyer (*)	Has NEW child of: Party identifier
Child	buyer	NEW	Buyer (*)	Has NEW child of: Additional Party Identifier
Attribute	buyer	NEW	Buyer (*)	Has NEW attribute: sender Party qualifier
Element(l)	characterSetCode	NEW	character set code	
Element(l)	characterSet	NEW	character set	
Element(l)	codeQualifier	NEW	code qualifier	
Child	csRange	NEW	color-size range	Has NEW child of: garment variant
Child	csRange	NEW	color-size range	Has NEW child of: drop identifier

Child	csRange	UPD ATE D	color-size range	relationship with child: articles colour identifier  Property: Aggregation Note_English Old value: New value: <i>used only if not already specified in the article code</i>
Attrib	additional ComponentCode	NEW	component Code	Has NEW attribute: code list reference
Attrib	additional ComponentCode	NEW	component Code	Has NEW attribute: numbering organisation code
Attrib	additional ComponentCode	NEW	component Code	Has NEW attribute: code list version
Attrib	additional ComponentCode	NEW	component Code	Has NEW attribute: code list name
Elem(l)	consumptionType	NEW	consumption type indicator	
Elem(E)	packageContainerN	UPD ATE D	container reference	Property: Length_Max Old value: 25 New value: 40
Elem(l)	criticalityIndicator	NEW	criticality indicator	
Elem(E)	deliveryPlace	UPD ATE D	delivery place	Property: Length_Max Old value: 40 New value: 250
Attrib	description	NEW	description	Has NEW attribute: In
Elem(E)	description	UPD ATE D	description	Property: Length_Max Old value: 70 New value: 250
Attrib	despatch Date	NEW	despatch date	Has NEW attribute: date format
Elem(l)	despatch Date	NEW	despatch date	
Elem(l)	despatch Place	NEW	despatch place	
Attrib	drop	NEW	drop identifier	Has NEW attribute: numbering organisation code
Attrib	drop	NEW	drop identifier	Has NEW attribute: code list name
Attrib	drop	NEW	drop identifier	Has NEW attribute: code list version
Elem(E)	email	UPD ATE D	e-mail	Property: Length_Max Old value: 80 New value: 250

Element(I)	encoding Code	NEW	encoding code	
Element(I)	encoding	NEW	encoding	
Child	endUseGroup	NEW	end use group	Has NEW child of: end use group identifier
Child	endUseGroup	NEW	end use group	Has NEW child of: color-size range
Child	endUseGroup	NEW	end use group	Has NEW child of: product quantity
Element(I)	endUseGroupId	NEW	end use group identifier	
Element(I)	endUseGroup	NEW	end use group	
Child	externalReference	NEW	external reference	Has NEW child of: uri
Child	externalReference	NEW	external reference	Has NEW child of: format code
Child	externalReference	NEW	external reference	Has NEW child of: character set code
Child	externalReference	NEW	external reference	Has NEW child of: mime code
Child	externalReference	NEW	external reference	Has NEW child of: encoding code
Element(I)	externalReference	NEW	external reference	
Child	fabricComponent	NEW	fabric component	Has NEW child of: items list
Child	fabricComponent	UPDATED	fabric component	relationship with child: general note  Property: Cardmax Old value: 19 New value: 99
Child	fabricComponent	UPDATED	fabric component	relationship with child: location identifier  Property: Aggregation Note_English Old value: <i>it may be used to specify the location where lie the pieces that the Subcontractor must use for the commissioned work operation</i> New value: <i>it may be used to specify the location where lie the pieces that the Subcontractor must use for the commissioned work operation</i>
Child	fabricComponent	UPDATED	fabric component	relationship with child: serial number  Property: Grp_pos Old value: 0 New value: 1

Child	fabricComponent	UPDATED	fabric component	relationship with child: serial number  Property: Gruppo Old value: 0 New value: -1
Child	fabricComponent	UPDATED	fabric component	relationship with child: serial number  Property: Cardmax Old value: 99 New value: 999
Child	fabricComponent	UPDATED	fabric component	relationship with child: product quantity  Property: Aggregation Note_English Old value: <i>here is the code of the component used in the yarn manufacturing operation</i> New value: <i>quantity to be consumed in the transformation. This element can have more instances only if the units of measure are different</i>
Child	fabricComponent	UPDATED	fabric component	relationship with child: reference document details  Property: Cardmax Old value: 1 New value: 9
Attribute	fabric	UPDATED	fabric identifier	Its attribute: code list reference  Property: Aggregation Note_English Old value: <i>this attribute should be ALTERNATIVE to the others</i> New value: <i>at least one out of this attribute and "numberingOrg" should be set</i>
Element(E)	piecePackText	UPDATED	fabric piece packing text	Property: Length_Max Old value: 40 New value: 250
Attribute	fileName	NEW	file name	Has NEW attribute: numbering organisation code
Element(l)	fileName	NEW	file name	
Attribute	fillingCriterion	NEW	filling criterion	Has NEW attribute: progressive number
Element(l)	fillingCriterion	NEW	filling criterion	
Element(l)	finalIndicator	NEW	final indicator	
Element(l)	formatCode	NEW	format code	
Element(l)	format	NEW	format	



Element(l)	garComInfo	NEW	garment commercial information	
Child	garmentCodeA	UPDATED	garment code A	relationship with child: description  Property: Cardmax Old value: 1 New value: 999
Child	garmentCodeA	UPDATED	garment code A	relationship with child: description  Property: Aggregation Note_English Old value: New value: <i>Product description</i>
Child	garmentCodeB	NEW	garment code B	Has NEW child of: drop identifier
Child	garmentCodeB	NEW	garment code B	Has NEW child of: garment variant
Child	garmentCodeB	UPDATED	garment code B	relationship with child: description  Property: Aggregation Note_English Old value: New value: <i>Product description</i>
Child	garmentCodeB	UPDATED	garment code B	relationship with child: description  Property: Cardmax Old value: 1 New value: 999
Child	garComInfo	NEW	garment commercial information	Has NEW child of: product specification date
Child	garComInfo	NEW	garment commercial information	Has NEW child of: operational code
Child	garComInfo	NEW	garment commercial information	Has NEW child of: Fabric piece packing details
Child	garComInfo	NEW	garment commercial information	Has NEW child of: yarn presentation details
Child	garComInfo	NEW	garment commercial information	Has NEW child of: project identifier
Child	garComInfo	NEW	garment commercial information	Has NEW child of: requested delivery date
Child	garComInfo	NEW	garment commercial information	Has NEW child of: Brand

Child	garComInfo	NEW	garment commercial information	Has NEW child of: Accessory packing details
Child	garComInfo	NEW	garment commercial information	Has NEW child of: product line
Attribute	garComInfo	NEW	garment commercial information	Has NEW attribute: end use code
Child	garComInfo	NEW	garment commercial information	Has NEW child of: season identifier
Child	garComInfo	NEW	garment commercial information	Has NEW child of: general note
Child	garComInfo	NEW	garment commercial information	Has NEW child of: garment packing
Attribute	garConsumption	NEW	garment component consumption	Has NEW attribute: consumption type indicator
Attribute	garConsumption	UPDATED	garment component consumption	Its attribute: numbering organisation code  Property: Aggregation Note_English Old value: New value: <i>to be used for garSizeCode</i>
Child	garConsumptionSet	NEW	garment consumption table	Has NEW child of: Garment product identifier
Child	garConsumptionSet	NEW	garment consumption table	Has NEW child of: Garment part code
Child	garConsumptionSet	NEW	garment consumption table	Has NEW child of: manufacture lot identifier
Child	garConsumptionSet	NEW	garment consumption table	Has NEW child of: dye bath identifier
Attribute	garPackCode	NEW	garment packing code	Has NEW attribute: code list name
Attribute	garPackCode	NEW	garment packing code	Has NEW attribute: numbering organisation code
Attribute	garPackCode	NEW	garment packing code	Has NEW attribute: code list version
Attribute	garPackCode	NEW	garment packing code	Has NEW attribute: code list reference
Child	garPack	NEW	garment packing	Has NEW child of: garment packing text

Child	garPack	NEW	garment packing	Has NEW child of: garment packing code
Child	garmentPartCode	NEW	Garment part code	Has NEW child of: articles additional identifier
Child	garmentPartCode	UPDATED	Garment part code	relationship with child: description  Property: Cardmax Old value: 1 New value: 999
Child	garmentPartCode	UPDATED	Garment part code	relationship with child: description  Property: Aggregation Note_English Old value: New value: <i>Product part description</i>
Child	garmentPartComponent	UPDATED	garment part component	relationship with child: product quantity  Property: BestPractice_English Old value: New value: <i>this element can have two instances only if the units of measure are different</i>
Child	garmentPartComponent	UPDATED	garment part component	relationship with child: general note  Property: Cardmax Old value: 19 New value: 99
Child	garmentPartComponent	UPDATED	garment part component	relationship with child: reference document details  Property: Cardmax Old value: 1 New value: 9
Attribute	garSizeSet	NEW	garment size set	Has NEW attribute: size system base
Attribute	garSizeSet	NEW	garment size set	Has NEW attribute: size system market segment
Attribute	garSizeSet	NEW	garment size set	Has NEW attribute: size system nationality
Child	garmentVariant	NEW	garment variant	Has NEW child of: variant code
Child	garmentVariant	NEW	garment variant	Has NEW child of: variant type
Element(l)	garmentVariant	NEW	garment variant	
Element(l)	garPackCode	NEW	garment packing code	
Element(l)	garPack	NEW	garment packing	

Elem(l)	garPackText	NEW	garment packing text	
Attribute	note	UPDATED	general note	<p>Its attribute: numbering organisation code</p> <p>Property: Aggregation Note_English</p> <p>Old value:</p> <p>New value: <i>must be used to specify the organization that created the list of codes used in "noteLabel"</i></p>
Attribute	artGroup	UPDATED	group identifier	<p>Its attribute: code list reference</p> <p>Property: Aggregation Note_English</p> <p>Old value: <i>this attribute should be ALTERNATIVE to the others</i></p> <p>New value: <i>at least one out of this attribute and "numberingOrg" should be set</i></p>
Child	handlingCharacter	NEW	handling Characteristics	Has NEW child of: general note
Child	handlingCharacter	NEW	handling Characteristics	Has NEW child of: garment packing
Child	handlingCharacter	NEW	handling Characteristics	Has NEW child of: yarn presentation details
Child	handlingCharacter	NEW	handling Characteristics	Has NEW child of: stackability Level
Child	handlingCharacter	NEW	handling Characteristics	Has NEW child of: gross weight measure
Child	handlingCharacter	NEW	handling Characteristics	Has NEW child of: net weight measure
Child	handlingCharacter	NEW	handling Characteristics	Has NEW child of: volume measure
Child	handlingCharacter	NEW	handling Characteristics	Has NEW child of: handling type
Child	handlingCharacter	NEW	handling Characteristics	Has NEW child of: Accessory packing details
Child	handlingCharacter	NEW	handling Characteristics	Has NEW child of: sortable Indicator
Child	handlingCharacter	NEW	handling Characteristics	Has NEW child of: Fabric piece packing details
Attribute	handlingType	NEW	handling type	Has NEW attribute: In
Elem(l)	handlingCharacter	NEW	handling Characteristics	
Elem(l)	handlingType	NEW	handling type	
Elem(l)	idQualifier	NEW	id Qualifier	

Element(E)	image	UPDATE	image address	Property: Length_Max Old value: 240 New value: 255
Element(I)	isCharge	NEW	is Charge	
Element(I)	isURL	NEW	is URL	
Child	itemIdentification	NEW	item identification	Has NEW child of: serial number
Element(I)	itemIdentification	NEW	item identification	
Child	itemsList	NEW	items list	Has NEW child of: quality level
Child	itemsList	NEW	items list	Has NEW child of: item identification
Attribute	itemsPerPackage	NEW	items per package	Has NEW attribute: unit of measure code
Element(I)	itemsList	NEW	items list	
Element(I)	itemsPerPackage	NEW	items per package	
Child	KCCOheader	NEW	KCCO header	Has NEW child of: validity start date
Child	KCCOheader	NEW	KCCO header	Has NEW child of: validity end date
Child	KCCOheader	UPDATE	KCCO header	relationship with child: Third Party  Property: Cardmax Old value: 1 New value: 5
Child	KCCOheader	UPDATE	KCCO header	relationship with child: general note  Property: Cardmax Old value: 19 New value: 99
Child	KCCOitem	NEW	KCCO item	Has NEW child of: phase
Child	KCCOitem	NEW	KCCO item	Has NEW child of: end use group
Child	KCCOitem	NEW	KCCO item	Has NEW child of: garment commercial information
Child	KCCOitem	NEW	KCCO item	Has NEW child of: priority
Child	KCCOitem	NEW	KCCO item	Has NEW child of: Transport packages details

Child	KCCOitem	NEW	KCCO item	Has NEW child of: general note
Child	KCCOitem	NEW	KCCO item	Has NEW child of: line identifier
Child	KCCOitem	UPDATE	KCCO item	relationship with child: requested delivery date  Property: Aggregation Note_English Old value: New value: <i>Delivery date should not be used here when the garCom Info.element is used.</i>
Element(l)	KCCOtype	NEW	KCCO type	
Attribute	KnitClothOrder	NEW	KnitClothOrder (*)	Has NEW attribute: KCCO type
Child	KnitClothOrder	NEW	KnitClothOrder (*)	Has NEW child of: garment commercial information
Element(E)	legalName	UPDATE	Legal name	Property: Length_Max Old value: 80 New value: 250
Element(E)	itemID	UPDATE	line item number	Property: Length_Max Old value: 6 New value: 40
Attribute	lineN	UPDATE	line number	Its attribute: VAT rate  Property: Aggregation Note_English Old value: New value: <i>Deprecated, prefer dtScheme when available.</i>
Element(l)	lineID	NEW	line identifier	
Element(l)	ln	NEW	ln	
Child	lotDetails	NEW	lot Details	Has NEW child of: color-size range
Child	lotDetails	NEW	lot Details	Has NEW child of: product quantity
Child	lotDetails	NEW	lot Details	Has NEW child of: manufacture lot identifier
Element(l)	lotDetails	NEW	lot Details	
Child	progress	NEW	Manufacture progress details	Has NEW child of: items list
Child	progress	NEW	Manufacture progress details	Has NEW child of: status reason

Child	progress	NEW	Manufacture progress details	Has NEW child of: quality level
Child	progress	UPD ATED	Manufacture progress details	relationship with child: product quantity  Property: BestPractice_English Old value: New value: <i>this element can have two instances only if the units of measure are different</i>
Element(E)	mfrStatusText	UPD ATED	manufacture stage text	Property: Length_Max Old value: 40 New value: 250
Element(I)	maxQty	NEW	maximum quantity	
Element(I)	mimeCode	NEW	mime code	
Element(I)	mime	NEW	mime	
Attribute	minItemsPerPackage	NEW	minimum items per package	Has NEW attribute: unit of measure code
Element(I)	minItemsPerPackage	NEW	minimum items per package	
Attribute	mod	UPD ATED	model identifier	Its attribute: code list reference  Property: Aggregation Note_English Old value: <i>this attribute should be ALTERNATIVE to the others</i> New value: <i>at least one out of this attribute and "numberingOrg" should be set</i>
Attribute	mod	UPD ATED	model identifier	Its attribute: numbering organisation code  Property: Aggregation Note_English Old value: <i>this attribute should be ALTERNATIVE to the others</i> New value:
Attribute	operationalCode	NEW	operational code	Has NEW attribute: numbering organisation code
Attribute	operationalCode	NEW	operational code	Has NEW attribute: code list reference
Attribute	operationalCode	NEW	operational code	Has NEW attribute: code qualifier
Attribute	operationalCode	NEW	operational code	Has NEW attribute: code list version
Attribute	operationalCode	NEW	operational code	Has NEW attribute: code list name
Element(I)	operationalCode	NEW	operational code	

Attrib	packageModelCode	NEW	package model code	Has NEW attribute: numbering organisation code
Element(E)	packageNumber	UPDATED	package number	Property: Length_Max Old value: 25 New value: 40
Element(I)	packageModelCode	NEW	package model code	
Attrib	phaseCode	NEW	phase code	Has NEW attribute: numbering organisation code
Attrib	phaseCode	NEW	phase code	Has NEW attribute: code list version
Attrib	phaseCode	NEW	phase code	Has NEW attribute: code list name
Attrib	phaseCode	NEW	phase code	Has NEW attribute: code list reference
Element(I)	phaseCode	NEW	phase code	
Attrib	phase	NEW	phase	Has NEW attribute: progressive number
Child	phase	NEW	phase	Has NEW child of: Transport packages details
Child	phase	NEW	phase	Has NEW child of: not before date
Child	phase	NEW	phase	Has NEW child of: garment consumption table
Child	phase	NEW	phase	Has NEW child of: Third Party
Child	phase	NEW	phase	Has NEW child of: reference document details
Element(I)	phase	NEW	phase	
Child	phase	NEW	phase	Has NEW child of: product quantity
Child	phase	NEW	phase	Has NEW child of: criticality indicator
Child	phase	NEW	phase	Has NEW child of: general note
Child	phase	NEW	phase	Has NEW child of: phase code
Child	phase	NEW	phase	Has NEW child of: requested delivery date
Child	phase	NEW	phase	Has NEW child of: unit price amount
Child	phase	NEW	phase	Has NEW child of: lot Details



Child	phase	NEW	phase	Has NEW child of: delivery granted date
Child	phase	NEW	phase	Has NEW child of: final indicator
Element(l)	priority	NEW	priority	
Attribute	productLine	NEW	product line	Has NEW attribute: code list name
Attribute	productLine	NEW	product line	Has NEW attribute: numbering organisation code
Attribute	productLine	NEW	product line	Has NEW attribute: code list reference
Attribute	productLine	NEW	product line	Has NEW attribute: code list version
Element(l)	productLine	NEW	product line	
Element(l)	progr	NEW	progressive number	
Element(E)	project	UPDATED	project identifier	Property: Length_Max Old value: 25 New value: 40
Attribute	qualityLevel	NEW	quality level	Has NEW attribute: numbering organisation code
Attribute	qualityLevel	NEW	quality level	Has NEW attribute: code list reference
Attribute	qualityLevel	NEW	quality level	Has NEW attribute: code list version
Attribute	qualityLevel	NEW	quality level	Has NEW attribute: code list name
Element(l)	qualityLevel	NEW	quality level	
Child	refDoc	NEW	reference document details	Has NEW child of: attachment
Child	refDoc	UPDATED	reference document details	relationship with child: document identifier  Property: BestPractice_English Old value: New value: <i>numberingOrg indicates the role that produced the document identifier (it is allowed to declare two different ones -e.g. customer and supplier - with two docID with different numberingOrg)</i>
Attribute	season	NEW	season identifier	Has NEW attribute: code list reference
Attribute	season	NEW	season identifier	Has NEW attribute: numbering organisation code

Attrib	season	NEW	season identifier	Has NEW attribute: code list name
Attrib	season	NEW	season identifier	Has NEW attribute: code list version
Attrib	serialN	NEW	serial number	Has NEW attribute: id Qualifier
Elem(E)	serialN	UPDATED	serial number	Property: Length_Max Old value: 15 New value: 250
Attrib	size	NEW	size identifier	Has NEW attribute: numbering organisation code
Attrib	size	NEW	size identifier	Has NEW attribute: code list name
Attrib	size	NEW	size identifier	Has NEW attribute: code list version
Child	sizeRow	NEW	size row	Has NEW child of: items list
Child	sizeRow	NEW	size row	Has NEW child of: component Code
Child	sizeRow	UPDATED	size row	relationship with child: drop identifier  Property: Aggregation Note_English Old value: New value: <i>DEPRECATED, anyhow it is used only if not already specified in the article code or csRange</i>
Attrib	garSizeCode	NEW	size tier code	Has NEW attribute: code list version
Attrib	garSizeCode	NEW	size tier code	Has NEW attribute: numbering organisation code
Attrib	garSizeCode	NEW	size tier code	Has NEW attribute: code list reference
Attrib	garSizeCode	NEW	size tier code	Has NEW attribute: code list name
Elem(I)	sortableIndicator	NEW	sortable Indicator	
Elem(I)	stackabilityLevel	NEW	stackability Level	
Elem(I)	statusReason	NEW	status reason	
Child	subContractor	NEW	Sub-contractor (*)	Has NEW child of: Party identifier
Attrib	subContractor	NEW	Sub-contractor (*)	Has NEW attribute: sender Party qualifier
Elem(I)	subDept	NEW	department identifier	

Attrib	legalRef	NEW	tax legal reference	Has NEW attribute: code list name
Attrib	legalRef	NEW	tax legal reference	Has NEW attribute: numbering organisation code
Attrib	legalRef	NEW	tax legal reference	Has NEW attribute: code list version
Attrib	legalRef	UPDATED	tax legal reference	Its attribute: code list reference  Property: Use Old value: <i>Required</i> New value: <i>Optional</i>
Child	dtScheme	UPDATED	tax scheme	relationship with child: general note  Property: Cardmax Old value: 19 New value: 99
Element(E)	payTermText	UPDATED	terms of payment text	Property: Length_Max Old value: 40 New value: 250
Element(E)	incotermsText	UPDATED	terms of trade text	Property: Length_Max Old value: 70 New value: 250
Element(E)	method	UPDATED	test method identifier	Property: Length_Max Old value: 25 New value: 80
Child	texCode	UPDATED	Textiles product code	relationship with child: description  Property: Aggregation Note_English Old value: New value: <i>Product description</i>
Child	texCode	UPDATED	Textiles product code	relationship with child: description  Property: Cardmax Old value: 1 New value: 999
Child	thirdParty	NEW	Third Party (*)	Has NEW child of: Party identifier
Attrib	thirdParty	NEW	Third Party (*)	Has NEW attribute: sender Party qualifier
Child	terms	UPDATED	Trade conditions	relationship with child: Transport information  Property: Cardmax Old value: 1 New value: 5
Element(E)	transportConditionText	UPDATED	transport condition - text	Property: Length_Max Old value: 100 New value: 250

Child	transInfo	NEW	Transport information	Has NEW child of: despatch place
Child	transInfo	NEW	Transport information	Has NEW child of: despatch date
Child	transInfo	NEW	Transport information	Has NEW child of: effective delivery date
Attribute	transInfo	NEW	Transport information	Has NEW attribute: progressive number
Element(E)	packageText	UPDATED	transport package text	Property: Length_Max Old value: 40 New value: 80
Child	packages	NEW	Transport packages details	Has NEW child of: items per package
Child	packages	NEW	Transport packages details	Has NEW child of: minimum items per package
Child	packages	NEW	Transport packages details	Has NEW child of: description
Child	packages	NEW	Transport packages details	Has NEW child of: handling Characteristics
Child	packages	NEW	Transport packages details	Has NEW child of: package model code
Child	packages	NEW	Transport packages details	Has NEW child of: filling criterion
Child	packages	UPDATED	Transport packages details	relationship with child: epc list  Property: Aggregation Note_English Old value: <i>here the RFID tags of the packages can be identified</i> New value: <i>this element is DEPRECATED, please use the specific elements</i>
Attribute	price	NEW	unit price amount	Has NEW attribute: data currency
Element(E)	price	UPDATED	unit price amount	Property: Digits_Dec Old value: 2 New value: 4
Attribute	uri	NEW	uri	Has NEW attribute: is URL
Element(I)	uri	NEW	uri	
Attribute	variantCode	NEW	variant code	Has NEW attribute: code list version
Attribute	variantCode	NEW	variant code	Has NEW attribute: code list name

Attrib	variantCode	NEW	variant code	Has NEW attribute: numbering organisation code
Attrib	variantCode	NEW	variant code	Has NEW attribute: code list reference
Attrib	variantType	NEW	variant type	Has NEW attribute: code list reference
Attrib	variantType	NEW	variant type	Has NEW attribute: code list version
Attrib	variantType	NEW	variant type	Has NEW attribute: code list name
Attrib	variantType	NEW	variant type	Has NEW attribute: numbering organisation code
Element(l)	variantCode	NEW	variant code	
Element(l)	variantType	NEW	variant type	
Child	yarnComponent	UPDATED	yarn component	relationship with child: product quantity  Property: BestPractice_English Old value: New value: <i>this element can have two instances only if the units of measure are different</i>
Child	yarnComponent	UPDATED	yarn component	relationship with child: general note  Property: Cardmax Old value: 19 New value: 99
Child	yarnComponent	UPDATED	yarn component	relationship with child: reference document details  Property: Cardmax Old value: 1 New value: 9
Element(E)	yarnOuterPackingText	UPDATED	yarn outer packing text	Property: Length_Max Old value: 40 New value: 250
Child	yarnCode	UPDATED	Yarn product code	relationship with child: description  Property: Aggregation Note_English Old value: New value: <i>Product description</i>
Child	yarnCode	UPDATED	Yarn product code	relationship with child: description  Property: Cardmax Old value: 1 New value: 999

## Annex D

### New or changed tables and codes towards previous version

Changes or added items (changes in CodeListAgencyName excluded; changes in adoption notes and code description included): 238

Test Type	Status	Table code	Table description	Code	Change description
Code	UPDATE	N1		A (the order is open without a concrete delivery of product; it establishes an amount of goods to be produced in a future)	adoption_note Old value: New value: <i>the order is open without a concrete delivery of product; it establishes an amount of goods to be produced in a future</i>
Code	UPDATE	N1		D (orders an amount of goods to be delivered (and invoiced and produced if necessary); it is important that it is clear that this amount should be subtracted from the amount of the blanket order referred in the refDoc element)	adoption_note Old value: New value: <i>orders an amount of goods to be delivered (and invoiced and produced if necessary); it is important that it is clear that this amount should be subtracted from the amount of the blanket order referred in the refDoc element</i>
Table	UPDATE	N10	eBIZ TCFUpstream version		Description_English Old value: <i>eBIZ Moda-ML version</i> New value: <i>eBIZ TCFUpstream version</i>
Code	NEW	N100		2018-1 (v2018-1)	
Code	NEW	N100		draft (draft)	
Table	UPDATE	N16	VAT rate or code		Generalities Old value: <i>VAT rate or code ( deprecated , use dtScheme element )</i> New value: <i>VAT rate or code ( DEPRECATED, use dtScheme element )</i>
Code	NEW	N2		AU (Auditor)	
Code	NEW	N2		CE (Certification authority)	

C o d e	NE W	N T 2		SC (Sub contractor)	
C o d e	NE W	N T 2		SM (Service/ePlatform manager)	
T a b l e	NE W	N T 39	consum ption typ e		
C o d e	NE W	N T 39		BOL (required quantity to obtain the indicate d total amount of product (Bill of Loadin g))	
C o d e	NE W	N T 39		BOM (required quantity for unit of product (Bill of material))	
C o d e	NE W	N T 4		SA (Sample)	
T a b l e	UP DA TE D	N T 4	end use		Generalities Old value: <i>specifies the final use of the fa bric</i> New value: <i>specifies the final use of the product</i>
C o d e	UP DA TE D	N T 41		C (neck center sleeve length)	Text_English Old value: New value: <i>neck center sleeve length</i>
C o d e	UP DA TE D	N T 41		E (under-sleeve length)	Text_English Old value: New value: <i>under-sleeve length</i>
C o d e	UP DA TE D	N T 41		F (raglan in front)	Text_English Old value: New value: <i>raglan in front</i>
C o d e	UP DA TE D	N T 41		G (muscle)	Text_English Old value: New value: <i>muscle</i>
C o d e	UP DA TE D	N T 41		H (bottom edge height)	Text_English Old value: New value: <i>bottom edge height</i>
C o	UP DA	N T 41		I (cuff height)	Text_English Old value: New value: <i>cuff height</i>

d e	TE D				
C o d e	UP DA TE D	N T 41		<i>L</i> (neck edge height)	Text_English Old value: New value: <i>neck edge height</i>
C o d e	UP DA TE D	N T 41		<i>M</i> (neck opening)	Text_English Old value: New value: <i>neck opening</i>
C o d e	UP DA TE D	N T 41		<i>N</i> (coppino)	Text_English Old value: New value: <i>coppino</i>
C o d e	UP DA TE D	N T 41		<i>O</i> (sleeve width to 10 cm)	Text_English Old value: New value: <i>sleeve width to 10 cm</i>
C o d e	UP DA TE D	N T 41		<i>P</i> (bottom width)	Text_English Old value: New value: <i>bottom width</i>
C o d e	UP DA TE D	N T 41		<i>CL</i> (neck)	Text_English Old value: New value: <i>neck</i>
C o d e	UP DA TE D	N T 41		<i>CV</i> (crotch)	Text_English Old value: New value: <i>crotch</i>
C o d e	UP DA TE D	N T 41		<i>FC</i> (hips)	Text_English Old value: New value: <i>hips</i>
C o d e	UP DA TE D	N T 41		<i>GM</i> (sleeve ride)	Text_English Old value: New value: <i>sleeve ride</i>
C o d e	UP DA TE D	N T 41		<i>LG</i> (width)	Text_English Old value: New value: <i>width</i>
C o d e	UP DA TE D	N T 41		<i>LM</i> (sleeve length)	Text_English Old value: New value: <i>sleeve length</i>
C o d e	UP DA TE D	N T 41		<i>LN</i> (length)	Text_English Old value: New value: <i>length</i>



C o d e	UP DA TE D	N T 41		<i>SP</i> (shoulders)	Text_English Old value: <i>shoulder</i> New value: <i>shoulders</i>
C o d e	UP DA TE D	N T 41		<i>VT</i> (waist)	Text_English Old value: New value: <i>waist</i>
T a b l e	NE W	N T 43	operatio nal code qualifier		
C o d e	NE W	N T 43		<i>1</i> (event)	
C o d e	NE W	N T 43		<i>2</i> (sales channel)	
C o d e	NE W	N T 43		<i>3</i> (goods management type)	
C o d e	NE W	N T 43		<i>4</i> (special initiative)	
T a b l e	NE W	N T 51	Filling C riterion f or Pack age ho mogenei ty		
C o d e	NE W	N T 51		<i>COL</i> (Colour)	
C o d e	NE W	N T 51		<i>MOD</i> (Model)	
C o d e	NE W	N T 51		<i>SIZ</i> (Size)	
C o d e	NE W	N T 6		<i>EB</i> (eBIZ)	

C o d e	UP DA TE D	N T 6		<i>ML</i> (DEPRECATED)	adoption_note Old value: New value: <i>DEPRECATED</i>
T a b l e	NE W	N T 60	language, codes from ISO 639-1 (subset)		
C o d e	NE W	N T 60		<i>F</i> (Female)	
C o d e	NE W	N T 60		<i>af</i> (Afrikaans)	
C o d e	NE W	N T 60		<i>ar</i> (Arabic)	
C o d e	NE W	N T 60		<i>be</i> (Belarusian)	
C o d e	NE W	N T 60		<i>bg</i> (Bulgarian)	
C o d e	NE W	N T 60		<i>bn</i> (Bengali)	
C o d e	NE W	N T 60		<i>bo</i> (Tibetan)	
C o d e	NE W	N T 60		<i>bs</i> (Bosnian)	
C o d e	NE W	N T 60		<i>ca</i> (Catalan, Valencian)	
C o d e	NE W	N T 60		<i>cs</i> (Czech)	
C o	NE W	N T 60		<i>da</i> (Danish)	

d e					
C o d e	NE W	N T 60		<i>de</i> (German)	
C o d e	NE W	N T 60		<i>el</i> (Greek, Modern (1453-))	
C o d e	NE W	N T 60		<i>en</i> (English)	
C o d e	NE W	N T 60		<i>eo</i> (Esperanto)	
C o d e	NE W	N T 60		<i>es</i> (Spanish, Castilian)	
C o d e	NE W	N T 60		<i>et</i> (Estonian)	
C o d e	NE W	N T 60		<i>eu</i> (Basque)	
C o d e	NE W	N T 60		<i>fa</i> (Persian)	
C o d e	NE W	N T 60		<i>fi</i> (Finnish)	
C o d e	NE W	N T 60		<i>fr</i> (French)	
C o d e	NE W	N T 60		<i>ga</i> (Irish)	
C o d e	NE W	N T 60		<i>gd</i> (Gaelic, Scottish Gaelic)	

C o d e	NE W	N T 60		<i>gn</i> (Guarani)	
C o d e	NE W	N T 60		<i>he</i> (Hebrew)	
C o d e	NE W	N T 60		<i>hr</i> (Croatian)	
C o d e	NE W	N T 60		<i>ht</i> (Haitian, Haitian Creole)	
C o d e	NE W	N T 60		<i>hu</i> (Hungarian)	
C o d e	NE W	N T 60		<i>hy</i> (Armenian)	
C o d e	NE W	N T 60		<i>ia</i> (Interlingua (International Auxiliary Language Association))	
C o d e	NE W	N T 60		<i>id</i> (Indonesian)	
C o d e	NE W	N T 60		<i>is</i> (Icelandic)	
C o d e	NE W	N T 60		<i>it</i> (Italian)	
C o d e	NE W	N T 60		<i>ja</i> (Japanese)	
C o d e	NE W	N T 60		<i>ju</i> (Javanese)	
C o d e	NE W	N T 60		<i>ka</i> (Georgian)	

C o d e	NE W	N T 60		<i>km</i> (Central Khmer)	
C o d e	NE W	N T 60		<i>ko</i> (Korean)	
C o d e	NE W	N T 60		<i>ku</i> (Kurdish)	
C o d e	NE W	N T 60		<i>lb</i> (Luxembourgish, Letzeburgesch)	
C o d e	NE W	N T 60		<i>lo</i> (Lao)	
C o d e	NE W	N T 60		<i>lt</i> (Lithuanian)	
C o d e	NE W	N T 60		<i>lv</i> (Latvian)	
C o d e	NE W	N T 60		<i>mg</i> (Malagasy)	
C o d e	NE W	N T 60		<i>mk</i> (Macedonian)	
C o d e	NE W	N T 60		<i>mn</i> (Mongolian)	
C o d e	NE W	N T 60		<i>mt</i> (Maltese)	
C o d e	NE W	N T 60		<i>nl</i> (Dutch, Flemish)	
C o d e	NE W	N T 60		<i>no</i> (Norwegian)	

C o d e	NE W	N T 60		<i>pl</i> (Polish)	
C o d e	NE W	N T 60		<i>pt</i> (Portuguese)	
C o d e	NE W	N T 60		<i>ro</i> (Romanian, Moldavian, Moldovan)	
C o d e	NE W	N T 60		<i>ru</i> (Russian)	
C o d e	NE W	N T 60		<i>se</i> (Northern Sami)	
C o d e	NE W	N T 60		<i>sk</i> (Slovak)	
C o d e	NE W	N T 60		<i>sl</i> (Slovenian)	
C o d e	NE W	N T 60		<i>sm</i> (Samoan)	
C o d e	NE W	N T 60		<i>so</i> (Somali)	
C o d e	NE W	N T 60		<i>sq</i> (Albanian)	
C o d e	NE W	N T 60		<i>sr</i> (Serbian)	
C o d e	NE W	N T 60		<i>sv</i> (Swedish)	
C o d e	NE W	N T 60		<i>sw</i> (Swahili)	

C o d e	NE W	N T 60		<i>ta</i> (Tamil)	
C o d e	NE W	N T 60		<i>th</i> (Thai)	
C o d e	NE W	N T 60		<i>tr</i> (Turkish)	
C o d e	NE W	N T 60		<i>uk</i> (Ukrainian)	
C o d e	NE W	N T 60		<i>ur</i> (Urdu)	
C o d e	NE W	N T 60		<i>uz</i> (Uzbek)	
C o d e	NE W	N T 60		<i>vi</i> (Vietnamese)	
C o d e	NE W	N T 60		<i>zh</i> (Chinese)	
C o d e	NE W	N T 7		<i>CMK</i> (square centimetre)	
C o d e	NE W	N T 7		<i>CMQ</i> (cubic centimetre)	
C o d e	NE W	N T 7		<i>E37</i> (pixel)	
C o d e	NE W	N T 7		<i>KWH</i> (kilowatthours)	
C o d e	NE W	N T 7		<i>MMK</i> (square millimetre)	

C o d e	NE W	N T 7		<i>MTK</i> (square metre)	
C o d e	NE W	N T 7		<i>CO2TON</i> (ton of CO2)	
T a b l e	UP DA TE D	N T 7	unit of m easure		OtherExternalReferenceURL Old value: New value: <a href="http://docs.oasis-open.org/ubl/os-UBL-2.1/cl/gc/default/UnitOfMeasureCode-2.1.gc#">#http://docs.oasis-open.org/ubl/os-UBL-2.1/cl/gc/default/UnitOfMeasureCode-2.1.gc#</a>
T a b l e	UP DA TE D	N T 7	unit of m easure		Description_English Old value: <i>unity of measure</i> New value: <i>unit of measure</i>
C o d e	NE W	T 11		<i>4G</i> (Box, fibreboard )	
C o d e	NE W	T 11		<i>4H</i> (Box, plastic )	
C o d e	NE W	T 11		<i>5H</i> (Bag, woven plastic )	
C o d e	NE W	T 11		<i>5L</i> (Bag, textile )	
C o d e	UP DA TE D	T 11		<i>5M</i> (Bag, paper)	Text_English Old value: <i>bag, paper</i> New value: <i>Bag, paper</i>
C o d e	NE W	T 11		<i>AJ</i> (Cone )	
C o d e	NE W	T 11		<i>BL</i> (Bale, compressed )	
C o d e	NE W	T 11		<i>BN</i> (Bale, non-compressed )	
C o	UP DA	T 11		<i>BX</i> (Box)	Text_English Old value: <i>box</i> New value: <i>Box</i>



d e	TE D				
C o d e	NE W	T 11		CI (Canister )	
C o d e	NE W	T 11		CL (Coil )	
C o d e	NE W	T 11		CN (Container, not otherwise specified as tr ansport equipment )	
C o d e	NE W	T 11		CS (Case )	
C o d e	NE W	T 11		CT (Carton )	
C o d e	NE W	T 11		EC (Bag, plastic )	
C o d e	NE W	T 11		ED (Case, with pallet base )	
C o d e	NE W	T 11		EE (Case, with pallet base, wooden )	
C o d e	NE W	T 11		EF (Case, with pallet base, cardboard )	
C o d e	NE W	T 11		EG (Case, with pallet base, plastic )	
C o d e	NE W	T 11		EH (Case, with pallet base, metal )	
C o d e	NE W	T 11		FX (Bag, flexible container )	
C o	NE W	T 11		HN (Hanger )	

d e					
C o d e	NE W	T 11		NF (Unpacked or unpackaged, single unit )	
C o d e	NE W	T 11		NG (Unpacked or unpackaged, multiple unit s )	
C o d e	NE W	T 11		OA (Pallet, CHEP 40 cm x 60 cm )	
C o d e	NE W	T 11		OB (Pallet, CHEP 80 cm x 120 cm )	
C o d e	NE W	T 11		OC (Pallet, CHEP 100 cm x 120 cm )	
C o d e	NE W	T 11		OD (Pallet, AS 4068-1993 )	
C o d e	NE W	T 11		OE (Pallet, ISO T11 )	
C o d e	NE W	T 11		RJ (Rack, clothing hanger )	
C o d e	NE W	T 11		RL (Reel )	
C o d e	NE W	T 11		SO (Spool )	
C o d e	NE W	T 11		ZZ (Mutually defined)	
T a b l e	UP DA TE D	T 11	transpor t packag e type		OtherExternalReferenceURL Old value: New value: # <a href="http://docs.oasis-open.org/ubl/os-UBL-2.1/cl/gc/default/TransportEquipmentTypeCode-2.1.gc#">http://docs.oasis-open.org/ubl/os-UBL-2.1/cl/gc/default/TransportEquipmentTypeCode-2.1.gc#</a>

T a b l e	UP DA TE D	T 11	transpor t packag e type		Generalities Old value: <i>code specifying the type of package used for transport and delivery</i> New value: <i>code specifying the type of package used for transport and delivery (subset of UN/ECE 8053 and UBL TransportEquipmentTypeCode-2.1)</i>
C o d e	NE W	T 21		<i>BOR</i> (blanket order)	
C o d e	NE W	T 21		<i>CEO</i> (Certificate of origin)	
C o d e	NE W	T 21		<i>CER</i> (Certificate)	
C o d e	UP DA TE D	T 21		<i>CTR</i> (Contract)	Text_English Old value: <i>contract</i> New value: <i>Contract</i>
C o d e	NE W	T 21		<i>MCI</i> (Visual merchandising instruction)	
C o d e	NE W	T 21		<i>VMI</i> (visual merchandising instructions)	
C o d e	NE W	T 41		<i>1</i> (Agreed settlement)	
C o d e	NE W	T 41		<i>2</i> (Below specification goods)	
C o d e	NE W	T 41		<i>3</i> (Damaged goods)	
C o d e	NE W	T 41		<i>4</i> (Short delivery)	
C o d e	NE W	T 41		<i>7</i> (Payment on account)	

C o d e	NE W	T 41		8 (Returnable container charge included)	
C o d e	NE W	T 41		9 (Invoice error)	
C o d e	NE W	T 41		10 (Costs for draft)	
C o d e	NE W	T 41		11 (Bank charges)	
C o d e	NE W	T 41		12 (Agent commission)	
C o d e	NE W	T 41		14 (Wrong delivery)	
C o d e	NE W	T 41		15 (Goods returned to agent)	
C o d e	NE W	T 41		16 (Goods partly returned)	
C o d e	NE W	T 41		17 (Transport damage)	
C o d e	NE W	T 41		19 (Trade discount)	
C o d e	NE W	T 41		20 (Deduction for late delivery)	
C o d e	NE W	T 41		21 (Advertising costs)	
C o d e	NE W	T 41		22 (Customs duties)	

C o d e	NE W	T 41		23 (Telephone and postal costs)	
C o d e	NE W	T 41		24 (Repair costs)	
C o d e	NE W	T 41		25 (Attorney fees)	
C o d e	NE W	T 41		26 (Taxes)	
C o d e	NE W	T 41		30 (Direct payment to seller)	
C o d e	NE W	T 41		32 (Goods not delivered)	
C o d e	NE W	T 41		33 (Late delivery)	
C o d e	NE W	T 41		35 (Goods returned)	
C o d e	NE W	T 41		36 (Invoice not received)	
C o d e	NE W	T 41		37 (Credit note to debtor/not to us)	
C o d e	NE W	T 41		38 (Deducted bonus)	
C o d e	NE W	T 41		39 (Deducted discount)	
C o d e	NE W	T 41		40 (Deducted freight costs)	

C o d e	NE W	T 41		41 (Deduction against other invoices)	
C o d e	NE W	T 41		42 (Credit balance(s))	
C o d e	NE W	T 41		45 (Debit note to seller)	
C o d e	NE W	T 41		46 (Discount beyond terms)	
C o d e	NE W	T 41		48 (Allowance/charge error)	
C o d e	NE W	T 41		49 (Substitute product)	
C o d e	NE W	T 41		50 (Terms of sale error)	
C o d e	NE W	T 41		52 (Wrong invoice)	
C o d e	NE W	T 41		53 (Duplicate invoice)	
C o d e	NE W	T 41		54 (Weight error)	
C o d e	NE W	T 41		55 (Additional charge not authorized)	
C o d e	NE W	T 41		56 (Incorrect discount)	
C o d e	NE W	T 41		57 (Price change)	

C o d e	NE W	T 41		58 (Variation)	
C o d e	NE W	T 41		59 (Chargeback)	
C o d e	NE W	T 41		65 (Settlement to agent)	
C o d e	NE W	T 41		66 (Cash discount)	
C o d e	NE W	T 41		70 (Wrong monetary amount resulting from incorrect free goods quantity)	
C o d e	NE W	T 41		72 (Temporary special promotion)	
C o d e	NE W	T 41		73 (Difference in tax rate)	
C o d e	NE W	T 41		74 (Quantity discount)	
C o d e	NE W	T 41		75 (Promotion discount)	
C o d e	NE W	T 41		76 (Cancellation deadline passed)	
C o d e	NE W	T 41		77 (Pricing discount)	
C o d e	NE W	T 41		78 (Volume discount)	
C o d e	NE W	T 41		79 (Sundry discount)	

T a b l e	UP DA TE D	T 41	type of Allowan ce or Ch arge		Generalities Old value: <i>coded specification of an Allowance or Charge</i> New value: <i>coded specification of an Allowance or Charge (elaborated from UNE CE 4465)</i>
C o d e	NE W	T 44		CO (company identification code)	
C o d e	NE W	T 48		BB (bottom back)	
C o d e	NE W	T 48		BF (bottom fore/front)	
C o d e	NE W	T 48		CO (collar)	
C o d e	NE W	T 48		CU (cuff)	
C o d e	NE W	T 48		DV (fore)	
C o d e	NE W	T 48		EM (embroidery)	
C o d e	NE W	T 48		OC (other component)	
C o d e	NE W	T 48		PO (pocket)	
C o d e	NE W	T 48		SC (back)	
C o d e	NE W	T 48		SL (sleeve)	
C o	NE W	T 48		TB (top back)	



d e					
C o d e	NE W	T 48		<i>TF</i> (top fore/front)	