



<http://www.ebiz-tcf.eu>

IMPLEMENTATION GUIDE

includes COMPARISON BETWEEN CURRENT and LAST
PREVIOUSLY RELEASED VERSION
TRANSACTION "TEXTILE PRINTING ORDER CHANGE"

Version: v2018-1

Date of release: 18/7/2019

Document code: G077rv

technical Documentation: <http://www.ebiz.enea.it>

XML Schemas repository: <http://www.ebiz.enea.it/moda-ml/repository/schema/v2018-1/default.asp>

Guides repository: <http://www.ebiz.enea.it/moda-ml/repository/guide/v2018-1/default.asp>

Guide filename: G077rv-eBIZ-TextilePrintingOrderChange.pdf

1. BUSINESS DESCRIPTION

1.1 Scope

The present guide has been issued to assist the companies of the Textile-Clothing sector in the implementation of the standard XML document type "TEXTILE PRINTING COMMISSION ORDER CHANGE", providing all the instruction required for its use in the context of e-commerce between Printing Subcontractors and their Customers shown in the enclosed diagram

All the rules required for the construction and validation of the document are embedded into the specific XML-Schema, which is detailed in section "Implementation guide".

1.2 Generalities

The Commissioner sends to the Subcontractor a Fabric printing Order Change any time he must modify some conditions of his previous Order (eg. to suspend operations already ordered) or amend errors.

Basic function of the message is to replace an invalid Order with a valid Order, amending:

- suppliable quantities
- dates and places of delivery
- prices

The Order Change can show a number of lines different from the related Order, when variations/cancellations have occurred so as to create the splitting of an Order Line.

However the sum of the quantities of the lines in the Order Change (confirmed + varied + cancelled) must always not less than the sum of the quantities in the original Order.

When the quantity is change the original line must be splitted and the confimed amount and canceled amount should be explicated through the 'act' flag.

1.3. Possible scenario

Subcontracted fabric printing

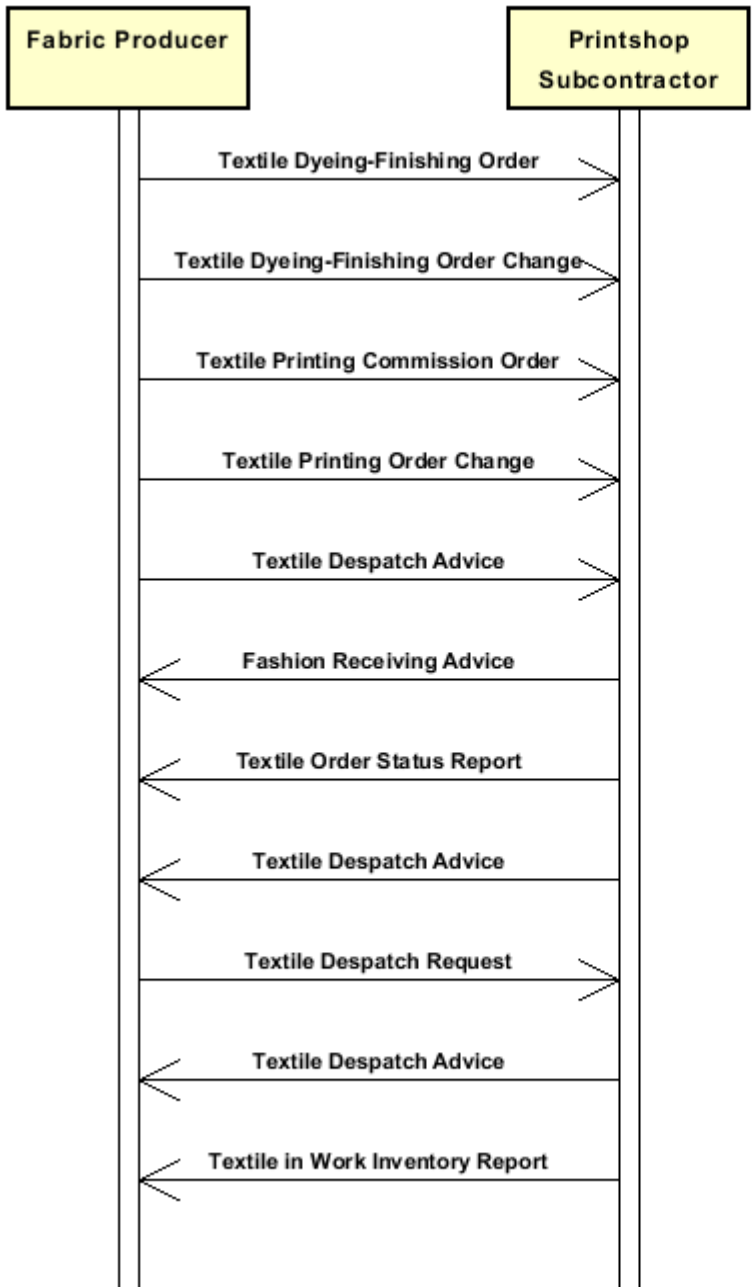

2. IMPLEMENTATION GUIDE

2.1 General structure of XML document

All the business data that can be exchanged through this class of documents are shown in the following "document structure", that provides a simplified vision of the Schema.

In particular:

- the two numbers following each element define its "cardinality" (minimum and maximum number of occurrences); the minimum equal zero indicates that the element is optional, the minimum greater than zero indicates that is mandatory;
- the bold character denotes the complex elements (aggregates of simple elements) that were built for the sake of functionality and re-usability of some complex informations sets. The child elements in each parent element are easily spotted as "indented";
- the symbol "@" denotes an attribute of the preceding element; here "the usage indicator (optional, required, ...)" is shown in square brackets.

Legenda

- N: new element
- U: updated properties
- P: changes in children
- p: is a changed child
- A: changes in attributes
- a: is a new or changed attribute
- *: is a subtype

Structure

TEXPrintOrdChange

@msgfunction [Optional]

@version [Optional] [Default= 2018-1]

@useProfile [Optional]

```
| TPCXheader 1-1 (P)
| | msgN 1-1
| | - choose -
| | docID 0-1
| | @numberingOrg [Optional]
| | - or -
| | msgID 0-1
| | - end choose -
| | msgDate 1-1
| | @dateForm [Optional]
| | season 0-1 (A)
| | @numberingOrg [Optional] (a)
| | @codeList [Optional] (a)
| | @listName [Optional] (a)
| | @listVersion [Optional] (a)
| | msgCurrency 0-1
| | refDoc 1-9 (P)
| | @docType [Required]
| | | docID 1-2 (p)
| | | @numberingOrg [Optional]
| | | docDate 0-1
| | | @dateForm [Optional]
| | | season 0-1 (A)
| | | @numberingOrg [Optional] (a)
| | | @codeList [Optional] (a)
| | | @listName [Optional] (a)
```

- | | | @listVersion [Optional] (a)
- | | | itemID 0-1 (U)
- | | | **attachment 0-1 (N)**
- | | | | @uid [Optional]
- | | | | | fileName 0-1 (N)
- | | | | | @numberingOrg [Optional]
- | | | | | binaryObject 0-1 (N)
- | | | | | @format [Optional] (N)
- | | | | | @mime [Optional] (N)
- | | | | | @encoding [Optional] (N)
- | | | | | @characterSet [Optional] (N)
- | | | | **externalReference 0-99 (N)**
- | | | | | uri 1-1 (N)
- | | | | | @isURL [Optional] [Default= true] (Na)
- | | | | | mimeTypeCode 0-1 (N)
- | | | | | formatCode 0-1 (N)
- | | | | | encodingCode 0-1 (N)
- | | | | | characterSetCode 0-1 (N)
- | | | **buyer 1-1 (AP)**
- | | | | @logo [Optional]
- | | | | @sender [Optional] (a*)
- | | | | | id 1-1 (p)
- | | | | | @numberingOrg [Optional]
- | | | | | additionalIdentifier 0-9 (N)
- | | | | | @numberingOrg [Optional] (a)
- | | | | | @idQualifier [Optional] (Na)
- | | | | | legalName 0-1 (U)
- | | | | | dept 0-1
- | | | | | subDept 0-1 (N)
- | | | | | person 0-1
- | | | | | | @email [Optional]
- | | | | | | @phone [Optional]
- | | | | | | @fax [Optional]
- | | | | | street 0-1
- | | | | | city 0-1
- | | | | | subCountry 0-1
- | | | | | country 0-1
- | | | | | postCode 0-1
- | | | **subContractor 1-1 (AP)**
- | | | | @sender [Optional] (a*)
- | | | | | id 1-1
- | | | | | @numberingOrg [Optional]
- | | | | | legalName 0-1 (U)
- | | | | | dept 0-1
- | | | | | subDept 0-1 (N)
- | | | | | person 0-1
- | | | | | | @email [Optional]
- | | | | | | @phone [Optional]
- | | | | | | @fax [Optional]
- | | | | | street 0-1
- | | | | | city 0-1
- | | | | | subCountry 0-1
- | | | | | country 0-1
- | | | | | postCode 0-1
- | | | **thirdParty 0-5 (AP)**
- | | | | @VAT [Optional]
- | | | | @role [Required]
- | | | | @sender [Optional] (a*)
- | | | | | id 1-1
- | | | | | @numberingOrg [Optional]
- | | | | | legalName 0-1 (U)

- | | dept 0-1
- | | subDept 0-1 (N)
- | | person 0-1
- | | @email [Optional]
- | | @phone [Optional]
- | | @fax [Optional]
- | | street 0-1
- | | city 0-1
- | | subCountry 0-1
- | | country 0-1
- | | postCode 0-1
- | | note 0-99
- | | @numberingOrg [Optional]
- | | @codeList [Optional]
- | | @noteLabel [Optional]

| **terms 0-1 (P)**

- | | **payment 0-5**
- | | @finDiscount [Optional]
- | | @finSurcharge [Optional]
- | | - choose -
- | | | payTerm 1-1
- | | | - or -
- | | | payTermText 1-1 (U)
- | | | - end choose -
- | | | payMode 0-1

- | | **insPayment 0-5**
- | | @part [Required]
- | | - choose -
- | | | payTerm 1-1
- | | | - or -
- | | | payTermText 1-1 (U)
- | | | - end choose -
- | | | payMode 0-1

- | | **trade 0-1**
- | | - choose -
- | | | incoTermText 1-1 (U)
- | | | - or -
- | | | incoTerm 1-1
- | | | - end choose -
- | | | location 0-1
- | | | @LRI [Optional]

- | | **transInfo 0-5 (pAP)**
- | | @transReason [Optional]
- | | @progr [Optional] (N)
- | | transMode 1-1
- | | carrier 0-1
- | | deliveryPlace 0-1 (U)
- | | grossWeight 0-1
- | | @um [Required]
- | | netWeight 0-1
- | | @um [Required]
- | | transMeans 0-1
- | | transCondition 0-3
- | | transConditionText 0-1 (U)
- | | despatchPlace 0-1 (N)
- | | despatchDate 0-1 (N)
- | | @dateForm [Optional] (a)
- | | delEffectiveDate 0-1 (p)
- | | @dateForm [Optional]

- | | **allowanceCharge 0-9 (A)**

```

| | @um [Optional] (a)
| | @VAT [Optional]
| | @minQty [Optional] (a)
| | @currency [Optional] (a)
| | @maxQty [Optional] (N)
| | @isCharge [Optional] (N)
| | - choose -
| | | AC_category 1-1
| | - or -
| | | AC_categoryText 1-1 (U)
| | - end choose -
| | - choose -
| | | AC_percent 1-1
| | - or -
| | | AC_amount 1-1 (A)
| | | @currency [Optional] (a)
| | - end choose -
| | | dtScheme 0-1 (P)
| | | @taxType [Required]
| | | taxCategory 0-1
| | | taxRate 0-1
| | | legalRef 0-1 (A)
| | | @numberingOrg [Optional] (a)
| | | @codeList [Optional] (a)
| | | @listName [Optional] (a)
| | | @listVersion [Optional] (a)
| | | note 0-99
| | | @numberingOrg [Optional]
| | | @codeList [Optional]
| | | @noteLabel [Optional]

```

TPCXbody 1-1

```

| | TPCXitem 1-unbounded (P)
| | @act [Required]
| | @productLevel [Optional] [Default= END]
| | lineN 1-1
| | @VAT [Optional]
| | refDoc 1-9 (P)
| | @docType [Required]
| | docID 1-2 (p)
| | @numberingOrg [Optional]
| | docDate 0-1
| | @dateForm [Optional]
| | season 0-1 (A)
| | @numberingOrg [Optional] (a)
| | @codeList [Optional] (a)
| | @listName [Optional] (a)
| | @listVersion [Optional] (a)
| | itemID 0-1 (U)
| | attachment 0-1 (N)
| | @uid [Optional]
| | | fileName 0-1 (N)
| | | @numberingOrg [Optional] (a)
| | | binaryObject 0-1 (N)
| | | @format [Optional] (Na)
| | | @mime [Optional] (Na)
| | | @encoding [Optional] (Na)
| | | @characterSet [Optional] (Na)
| | | externalReference 0-99 (N)
| | | uri 1-1 (N)
| | | @isURL [Optional] [Default= true] (Na)

```

```

| | | | | mimeCode 0-1 (N)
| | | | | formatCode 0-1 (N)
| | | | | encodingCode 0-1 (N)
| | | | | characterSetCode 0-1 (N)
| | | | | fabricProd 0-1 (P)
| | | | | @CTest [Optional]
| | | | | | texCode 1-1 (P)
| | | | | | | @numberingOrg [Optional]
| | | | | | | | art 1-1 (U)
| | | | | | | | | @numberingOrg [Optional]
| | | | | | | | | @codeList [Optional]
| | | | | | | | | @listName [Optional]
| | | | | | | | | @listVersion [Optional]
| | | | | | | | pattern 0-1
| | | | | | | | | @numberingOrg [Optional]
| | | | | | | | | @codeList [Optional]
| | | | | | | | | @listName [Optional]
| | | | | | | | | @listVersion [Optional]
| | | | | | | | color 0-1
| | | | | | | | | @numberingOrg [Optional]
| | | | | | | | | @codeList [Optional]
| | | | | | | | | @listName [Optional]
| | | | | | | | | @listVersion [Optional]
| | | | | | | | added 0-9
| | | | | | | | | @numberingOrg [Optional]
| | | | | | | | | @addType [Optional]
| | | | | | | | description 0-unbounded (AU)
| | | | | | | | | @ln [Optional] (N)
| | | | | | | fabricCompos 0-1
| | | | | | | | percCompos 1-9
| | | | | | | | | @fibre [Required]
| | | | | | | fabricWidth 0-1
| | | | | | | | @um [Optional] [Default= CMT]
| | | | | | | fabricSpecs 0-99
| | | | | | | - choose -
| | | | | | | | fabricCharText 1-1 (U)
| | | | | | | | - or -
| | | | | | | | fabricChar 1-1
| | | | | | | | - end choose -
| | | | | | | | specValue 0-1
| | | | | | | | | @um [Optional]
| | | | | | | | | @source [Optional]
| | | | | | | | | @method [Optional]
| | | | | | | | | @application [Optional]
| | | | | | | | | @CV [Optional]
| | | | | | | | - choose -
| | | | | | | | tolerance 0-2
| | | | | | | | | @um [Required]
| | | | | | | | - or -
| | | | | | | | pcTolerance 0-2
| | | | | | | | | @um [Optional]
| | | | | | | | - end choose -
| | | | | | | - choose -
| | | | | | | | pieceChain 0-99 (P)
| | | | | | | | | serialN 1-9 (AU)
| | | | | | | | | | @numberingOrg [Optional]
| | | | | | | | | | @idQualifier [Optional] (N)
| | | | | | | | | pieceLength 0-1
| | | | | | | | | | @um [Optional] [Default= MTR]
| | | | | | | | | pieceWidth 0-1
| | | | | | | | | | @um [Optional] [Default= CMT]

```



```

| | | | pieceWeight 0-1
| | | | @um [Optional] [Default= KGM]
| | | | lotN 0-1
| | | | @numberingOrg [Optional]
| | | | dyeN 0-1
| | | | @numberingOrg [Optional]
| | | | packageN 0-1 (U)
| | | | @numberingOrg [Optional]
| | | | @packageContainerN [Optional]
| | | | piecePack 0-1
- choose -
| | | | piecePackText 1-1 (U)
- or -
| | | | pieceInnWrap1 1-1
| | | | pieceInnWrap2 0-1
| | | | pieceOutWrap 0-1
- end choose -
| | | | pieceCut 0-99 (P)
| | | | serialN 1-9 (AU)
| | | | @numberingOrg [Optional]
| | | | @idQualifier [Optional] (N)
| | | | pieceLength 0-1
| | | | @um [Optional] [Default= MTR]
| | | | pieceWeight 0-1
| | | | @um [Optional] [Default= KGM]

```

- or -

```

| | | | piece 0-99 (P)
| | | | @endUse [Optional]
| | | | serialN 0-9 (AU)
| | | | @numberingOrg [Optional]
| | | | @idQualifier [Optional] (N)
| | | | EPC 0-1
| | | | @numberingOrg [Optional]
| | | | @TID [Optional]
| | | | totFault 0-1
| | | | pieceStatus 0-1
| | | | pieceLength 0-1
| | | | @um [Optional] [Default= MTR]
| | | | pieceWidth 0-1
| | | | @um [Optional] [Default= CMT]
| | | | pieceCutWidth 0-1
| | | | @um [Optional] [Default= CMT]
| | | | pieceWeight 0-1
| | | | @um [Optional] [Default= KGM]
| | | | pieceWeightM 0-1
| | | | @um [Optional] [Default= GRM]
| | | | grossWeight 0-1
| | | | @um [Required]
| | | | pieceAllow 0-1
| | | | @um [Required]
| | | | lotN 0-2
| | | | @numberingOrg [Optional]
| | | | dyeN 0-1
| | | | @numberingOrg [Optional]
| | | | mixMatch 0-1
| | | | @numberingOrg [Optional]
| | | | packageN 0-1 (U)
| | | | @numberingOrg [Optional]
| | | | @packageContainerN [Optional]
| | | | piecePack 0-1
- choose -

```

```

| | | | | piecePackText 1-1 (U)
| | | | | - or -
| | | | | pieceInnWrap1 1-1
| | | | | pieceInnWrap2 0-1
| | | | | pieceOutWrap 0-1
| | | | | - end choose -
| | | | | - end choose -
| | | | | note 0-99
| | | | | @numberingOrg [Optional]
| | | | | @codeList [Optional]
| | | | | @noteLabel [Optional]
| | | | | qty 0-3
| | | | | @um [Required]
| | | | | price 0-1 (AU)
| | | | | @um [Optional]
| | | | | @priceQualifier [Optional] [Default= NET]
| | | | | @currency [Optional] (a)
| | | | | deliveryDate 0-1
| | | | | @dateForm [Optional]
| | | | | thirdParty 0-3 (AP)
| | | | | @VAT [Optional]
| | | | | @role [Required]
| | | | | @sender [Optional] (a*)
| | | | | | id 1-1
| | | | | | @numberingOrg [Optional]
| | | | | | legalName 0-1 (U)
| | | | | | dept 0-1
| | | | | | subDept 0-1 (N)
| | | | | | person 0-1
| | | | | | @email [Optional]
| | | | | | @phone [Optional]
| | | | | | @fax [Optional]
| | | | | | street 0-1
| | | | | | city 0-1
| | | | | | subCountry 0-1
| | | | | | country 0-1
| | | | | | postCode 0-1
| | | | | fabricComponent 0-9 (P)
| | | | | | texCode 1-1 (P)
| | | | | | @numberingOrg [Optional]
| | | | | | | art 1-1 (U)
| | | | | | | @numberingOrg [Optional]
| | | | | | | @codeList [Optional]
| | | | | | | @listName [Optional]
| | | | | | | @listVersion [Optional]
| | | | | | | pattern 0-1
| | | | | | | @numberingOrg [Optional]
| | | | | | | @codeList [Optional]
| | | | | | | @listName [Optional]
| | | | | | | @listVersion [Optional]
| | | | | | | color 0-1
| | | | | | | @numberingOrg [Optional]
| | | | | | | @codeList [Optional]
| | | | | | | @listName [Optional]
| | | | | | | @listVersion [Optional]
| | | | | | | added 0-9
| | | | | | | @numberingOrg [Optional]
| | | | | | | @addType [Optional]
| | | | | | | description 0-unbounded (pAU)
| | | | | | | @ln [Optional] (N)
| | | | | | qty 1-3

```

```

| | | | @um [Required]
| | | | - choose -
| | | | serialN 0-unbounded (AU)
| | | | @numberingOrg [Optional]
| | | | @idQualifier [Optional] (N)
| | | | - or -
| | | | itemsList 0-unbounded (N)
| | | | | qualityLevel 0-1 (N)
| | | | | @numberingOrg [Optional] (a)
| | | | | @codeList [Optional] (a)
| | | | | @listName [Optional] (a)
| | | | | @listVersion [Optional] (a)
| | | | | itemIdentification 1-unbounded (N)
| | | | | | serialN 1-9 (AU)
| | | | | | @numberingOrg [Optional]
| | | | | | @idQualifier [Optional] (N)
| | | | - end choose -
| | | | refDoc 0-9 (P)
| | | | | @docType [Required]
| | | | | | docID 1-2 (p)
| | | | | | @numberingOrg [Optional]
| | | | | | docDate 0-1
| | | | | | @dateForm [Optional]
| | | | | | season 0-1 (A)
| | | | | | @numberingOrg [Optional] (a)
| | | | | | @codeList [Optional] (a)
| | | | | | @listName [Optional] (a)
| | | | | | @listVersion [Optional] (a)
| | | | | | itemID 0-1 (U)
| | | | | | attachment 0-1 (N)
| | | | | | | @uid [Optional]
| | | | | | | | fileName 0-1 (N)
| | | | | | | | @numberingOrg [Optional] (a)
| | | | | | | | binaryObject 0-1 (N)
| | | | | | | | @format [Optional] (Na)
| | | | | | | | @mime [Optional] (Na)
| | | | | | | | @encoding [Optional] (Na)
| | | | | | | | @characterSet [Optional] (Na)
| | | | | | | | externalReference 0-99 (N)
| | | | | | | | | uri 1-1 (N)
| | | | | | | | | @isURL [Optional] [Default= true] (Na)
| | | | | | | | | mimeTypeCode 0-1 (N)
| | | | | | | | | formatCode 0-1 (N)
| | | | | | | | | encodingCode 0-1 (N)
| | | | | | | | | characterSetCode 0-1 (N)
| | | | | location 0-1
| | | | | | @LRI [Optional]
| | | | | note 0-99
| | | | | | @numberingOrg [Optional]
| | | | | | @codeList [Optional]
| | | | | | @noteLabel [Optional]
| | | | fabPrintOperation 0-9 (P)
| | | | | fabPrintTech 1-1
| | | | | dyeStuff 0-1
| | | | | fabPrintSpecs 0-9
| | | | | - choose -
| | | | | | fabPrintCharText 1-1 (U)
| | | | | | - or -
| | | | | | fabPrintChar 1-1
| | | | | - end choose -
| | | | | specValue 0-1

```

| @um [Optional]
 | @source [Optional]
 | @method [Optional]
 | @application [Optional]
 | @CV [Optional]
 groundColor 0-9
 @numberingOrg [Optional]
 @screenN [Required]
refDoc 0-9 (P)
 @docType [Required]
 | docID 1-2 (p)
 | @numberingOrg [Optional]
 | docDate 0-1
 | @dateForm [Optional]
 | season 0-1 (A)
 | @numberingOrg [Optional] (a)
 | @codeList [Optional] (a)
 | @listName [Optional] (a)
 | @listVersion [Optional] (a)
 | itemID 0-1 (U)
attachment 0-1 (N)
 @uid [Optional]
 | fileName 0-1 (N)
 | @numberingOrg [Optional] (a)
 | binaryObject 0-1 (N)
 | @format [Optional] (Na)
 | @mime [Optional] (Na)
 | @encoding [Optional] (Na)
 | @characterSet [Optional] (Na)
externalReference 0-99 (N)
 | uri 1-1 (N)
 | @isURL [Optional] [Default= true] (Na)
 | mimeTypeCode 0-1 (N)
 | formatCode 0-1 (N)
 | encodingCode 0-1 (N)
 | characterSetCode 0-1 (N)
 note 0-99
 @numberingOrg [Optional]
 @codeList [Optional]
 @noteLabel [Optional]
dtScheme 0-1 (P)
 @taxType [Required]
 | taxCategory 0-1
 | taxRate 0-1
 | legalRef 0-1 (A)
 | @numberingOrg [Optional]
 | @codeList [Optional]
 | @listName [Optional]
 | @listVersion [Optional]
 note 0-99
 @numberingOrg [Optional]
 @codeList [Optional]
 @noteLabel [Optional]

2.2 Detailed description of document elements

Following tables show all elements (complex and simple) used in this document. Description includes: 1) element's information: xml tag, name, brief description, data type and syntax constraints; 2) information about use of the element in a particular position in the document: xpath and possible associated notes.

2.2.1 Complex elements (Aggregate Business Information Entities)

Complex elements are those elements whose content is composed of other elements (childs).Complex elements are alphabetically ordered.

allowanceCharge	Allowances and Charges related to an Order or a contract (XPath <code>TEXPrintOrdChange/terms/allowanceCharge</code>) 0-9 (A)
attachment	an attached document. An attachment can refer to an external document or be included with the document being exchanged (XPath <code>TEXPrintOrdChange/TPCXheader/refDoc/attachment</code>) 0-1 (N) (XPath <code>TEXPrintOrdChange/TPCXbody/TPCXitem/refDoc/attachment</code>) 0-1 (N) (XPath <code>TEXPrintOrdChange/TPCXbody/TPCXitem/fabricComponent/refDoc/attachment</code>) 0-1 (N) (XPath <code>TEXPrintOrdChange/TPCXbody/TPCXitem/fabPrintOperation/refDoc/attachment</code>) 0-1 (N)
buyer	details of the Buyer (party that buys the good or service that is object of the current collaborative process) - base type: Nad, (XPath <code>TEXPrintOrdChange/TPCXheader/buyer</code>) 1-1 (AP)
dtScheme	set of data usable to declare the duty or tax applied (XPath <code>TEXPrintOrdChange/TPCXbody/TPCXitem/dtScheme</code>) 0-1 (P) (XPath <code>TEXPrintOrdChange/terms/allowanceCharge/dtScheme</code>) 0-1 (P)
externalReference	details about an external object, such as a document stored at a remote location (XPath <code>TEXPrintOrdChange/TPCXheader/refDoc/attachment/externalReference</code>) 0-99 (N) (XPath <code>TEXPrintOrdChange/TPCXbody/TPCXitem/fabPrintOperation/refDoc/attachment/externalReference</code>) 0-99 (N) (XPath <code>TEXPrintOrdChange/TPCXbody/TPCXitem/fabricComponent/refDoc/attachment/externalReference</code>) 0-99 (N) (XPath <code>TEXPrintOrdChange/TPCXbody/TPCXitem/refDoc/attachment/externalReference</code>) 0-99 (N)
fabPrintOperation	details of a fabric printing operation (XPath <code>TEXPrintOrdChange/TPCXbody/TPCXitem/fabPrintOperation</code>) 0-9 (P)
fabPrintSpecs	technical specifications of a fabric printing operation (XPath <code>TEXPrintOrdChange/TPCXbody/TPCXitem/fabPrintOperation/fabPrintSpecs</code>) 0-9
fabricComponent	identification details of a fabric used in a sub-contracted manufacturing operation (XPath <code>TEXPrintOrdChange/TPCXbody/TPCXitem/fabricComponent</code>) 0-9 (P)
fabricCompos	composition of the fabric according to the Directory 97/37/CE (XPath <code>TEXPrintOrdChange/TPCXbody/TPCXitem/fabricProd/fabricCompos</code>) 0-1
fabricProd	manufacturing specifications of the product to be obtained from an operation of the sub-contracted production of fabric

	(XPath TEXPrintOrdChange/TPCXbody/TPCXitem/fabricProd) 0-1 (P)
fabricSpecs	technical characteristics of fabric, linked either to an operation of subcontracted production or to the purchase (XPath TEXPrintOrdChange/TPCXbody/TPCXitem/fabricProd/fabricSpecs) 0-99
insPayment	payment details for payment by installments (XPath TEXPrintOrdChange/terms/insPayment) 0-5 - note: <i>excluded the case of offers, this set of data is alternative to payment set and must be iterated for each payment installment</i>
itemIdentification	serial identification of a product unit (XPath TEXPrintOrdChange/TPCXbody/TPCXitem/fabricComponent/itemsList/itemIdentification) 1-unbounded (N) - note: <i>identification of the single product unit contained in the list</i>
itemsList	list of the single product units (XPath TEXPrintOrdChange/TPCXbody/TPCXitem/fabricComponent/itemsList) 0-unbounded (N) - note: <i>it may be used to identify the pieces/chains that the Subcontractor must use for the commissioned work with multiple serial Ids for each one</i>
payment	payment details for payment all in one (XPath TEXPrintOrdChange/terms/payment) 0-5 - note: <i>excluded the case of offers, this set of data is alternative to insPayment, it can be iterated to specify alternative terms of payment (e.g.: 60 days or 30 days with 3% discount)</i>
piece	Identification data and measurement of the fabric piece. (XPath TEXPrintOrdChange/TPCXbody/TPCXitem/fabricProd/piece) 0-99 (P)
pieceChain	identification data and measurements of a chain of pieces still to be cut (XPath TEXPrintOrdChange/TPCXbody/TPCXitem/fabricProd/pieceChain) 0-99 (P)
pieceCut	identification data and measurements of a fabric piece belonging to a chain still to be cut (XPath TEXPrintOrdChange/TPCXbody/TPCXitem/fabricProd/pieceChain/pieceCut) 0-99 (P) - note: <i>here the data of the pieces making up the chain should be specified</i>
piecePack	type of wrapping or packing of the fabric pieces (XPath TEXPrintOrdChange/TPCXbody/TPCXitem/fabricProd/piece/piecePack) 0-1 (XPath TEXPrintOrdChange/TPCXbody/TPCXitem/fabricProd/pieceChain/piecePack) 0-1
refDoc	identification of a document and of an item thereof, to which the message makes reference (XPath TEXPrintOrdChange/TPCXbody/TPCXitem/refDoc) 1-9 (P) - note: <i>At least one occurrence should contain a reference to the line of the order it responds to (for example docType=ORD or OCH or BOR)</i> (XPath TEXPrintOrdChange/TPCXheader/refDoc) 1-9 (P) - note: <i>At least one occurrence should contain a reference to the order it responds to (for example docType=ORD or OCH or BOR)</i> (XPath TEXPrintOrdChange/TPCXbody/TPCXitem/fabPrintOperation/refDoc) 0-9 (P) (XPath TEXPrintOrdChange/TPCXbody/TPCXitem/fabricComponent/refDoc) 0-9 (P) - note: <i>here the delivery documents can be specified</i>
subContractor	details of the Sub-contractor - base type: Nad, (XPath TEXPrintOrdChange/TPCXheader/subContractor) 1-1 (AP)
terms	details of the commercial obligations for payment and delivery

	(XPath TEXPrintOrdChange/terms) 0-1 (P)
texCode	full codification of the textile product (XPath TEXPrintOrdChange/TPCXbody/TPCXitem/fabricComponent/texCode) 1-1 (P) (XPath TEXPrintOrdChange/TPCXbody/TPCXitem/fabricProd/texCode) 1-1 (P)
thirdParty	details of the Third Party, different from Sender and Receiver of the document - base type: Nad, (XPath TEXPrintOrdChange/TPCXheader/thirdParty) 0-5 (AP) (XPath TEXPrintOrdChange/TPCXbody/TPCXitem/thirdParty) 0-3 (AP)
TPCXbody	body of the document "TEXTILES PRINTING COMMISSION ORDER CHANGE" (XPath TEXPrintOrdChange/TPCXbody) 1-1
TPCXheader	header of the document "TEXTILES PRINTING COMMISSION ORDER CHANGE" (XPath TEXPrintOrdChange/TPCXheader) 1-1 (P)
TPCXitem	line item of the document "TEXTILES PRINTING COMMISSION ORDER CHANGE" (XPath TEXPrintOrdChange/TPCXbody/TPCXitem) 1-unbounded (P)
trade	general terms of trade for the specified supply (XPath TEXPrintOrdChange/terms/trade) 0-1
transInfo	details of transport: mode, carrier and delivery place (XPath TEXPrintOrdChange/terms/transInfo) 0-5 (pAP)

2.2.2 Simple elements (Basic Business Information Entities)

Simple elements are those elements whose content is characterized by a data type plus a domain of possible values. Simple elements are alphabetically ordered.

AC_amount	amount of an Allowance or Charge - base type: decimal, fraction digits: 2, (XPath TEXPrintOrdChange/terms/allowanceCharge/AC_amount) 1-1 (A)
AC_category	coded specification of an Allowance or Charge - base type: string, cod. table: T41 http://www.ebiz.enea.it/moda-ml/repository/codelist/v2018-1/gc_T41.xml (XPath TEXPrintOrdChange/terms/allowanceCharge/AC_category) 1-1
AC_categoryText	free text description of an Allowance or Charge - base type: string, max length: 250, (XPath TEXPrintOrdChange/terms/allowanceCharge/AC_categoryText) 1-1 (U)
AC_percent	amount of an Allowance or Charge as a percentage (always non negative value) - base type: decimal, max inclusive: 100, fraction digits: 2, (XPath TEXPrintOrdChange/terms/allowanceCharge/AC_percent) 1-1
@act	status that the current line assigns to the line addressed in the reference document; if it is already canceled it maintains the status. - base type: string, cod. table: NT5 http://www.ebiz.enea.it/moda-ml/repository/codelist/v2018-1/gc_NT5.xml (XPath TEXPrintOrdChange/TPCXbody/TPCXitem/@act) [Required]
added	additional code of the product (complementing the formers) - base type: string, max length: 80,

	<p>(XPath TEXPrintOrdChange/TPCXbody/TPCXitem/fabricProd/texCode/added) 0-9</p> <p>- note: <i>here an additional codification (see table T44) can be specified</i></p> <p>(XPath TEXPrintOrdChange/TPCXbody/TPCXitem/fabricComponent/texCode/added) 0-9</p> <p>- note: <i>here an additional codification (see table T44) can be specified</i></p>
additionalIdentifier	<p>additional identification code of a Party, for example customs registries or others</p> <p>- base type: string, max length: 15,</p> <p>(XPath TEXPrintOrdChange/TPCXheader/buyer/additionalIdentifier) 0-9 (N)</p> <p>- note: <i>identifiers for example for exports, such as MID (Manufacturer Identification Code), EORI (E.O.R.I. - Economic Operator Registration and Identification)</i></p>
@addType	<p>qualifier of the additional coding of a product</p> <p>- base type: string, cod. table: T44</p> <p>http://www.ebiz.enea.it/moda-ml/repository/codelist/v2018-1/gc_T44.xml</p> <p>(XPath TEXPrintOrdChange/TPCXbody/TPCXitem/fabricProd/texCode/added/@addType) [Optional]</p> <p>- nota: <i>addType allows the clarification of the meaning of the added element content; it is strongly suggested to use it always.</i></p> <p>(XPath TEXPrintOrdChange/TPCXbody/TPCXitem/fabricComponent/texCode/added/@addType) [Optional]</p> <p>- nota: <i>addType allows the clarification of the meaning of the added element content; it is strongly suggested to use it always.</i></p>
@application	<p>force or similar condition (e.g. no. of revolutions) applied in a test as specified within the standard</p> <p>- base type: string, max length: 15,</p> <p>(XPath TEXPrintOrdChange/TPCXbody/TPCXitem/fabPrintOperation/fabPrintSpecs/specValue/@application) [Optional]</p> <p>(XPath TEXPrintOrdChange/TPCXbody/TPCXitem/fabricProd/fabricSpecs/specValue/@application) [Optional]</p>
art	<p>article number of the product</p> <p>- base type: string, max length: 80,</p> <p>(XPath TEXPrintOrdChange/TPCXbody/TPCXitem/fabricProd/texCode/art) 1-1 (U)</p> <p>- note: <i>can be used either for the base-article (excluding pattern/colour) or for the SKU</i></p> <p>(XPath TEXPrintOrdChange/TPCXbody/TPCXitem/fabricComponent/texCode/art) 1-1 (U)</p> <p>- note: <i>can be used either for the base-article (excluding pattern/colour) or for the SKU</i></p>
binaryObject	<p>a binary large object containing an attached document, Coding 'base64Binary' is recommended.</p> <p>- base type: base64Binary,</p> <p>(XPath TEXPrintOrdChange/TPCXbody/TPCXitem/fabPrintOperation/refDoc/attachment/binaryObject) 0-1 (N)</p> <p>(XPath TEXPrintOrdChange/TPCXbody/TPCXitem/refDoc/attachment/binaryObject) 0-1 (N)</p> <p>(XPath TEXPrintOrdChange/TPCXbody/TPCXitem/fabricComponent/refDoc/attachment/binaryObject) 0-1 (N)</p> <p>(XPath TEXPrintOrdChange/TPCXheader/refDoc/attachment/binaryObject) 0-1 (N)</p>
carrier	<p>identification of the transport carrier</p> <p>- base type: string, max length: 40,</p> <p>(XPath TEXPrintOrdChange/terms/transInfo/carrier) 0-1</p>

<p>@characterSet</p>	<p>the character set of the binary object (examples UTF-8, UTF-16, Windows-1252, ISO-8859-7,...)</p> <ul style="list-style-type: none"> - base type: normalizedString, (XPath <code>TEXPrintOrdChange/TPCXbody/TPCXitem/refDoc/attachment/binaryObject/@characterSet</code>) [Optional] (Na) (XPath <code>TEXPrintOrdChange/TPCXbody/TPCXitem/fabricComponent/refDoc/attachment/binaryObject/@characterSet</code>) [Optional] (Na) (XPath <code>TEXPrintOrdChange/TPCXheader/refDoc/attachment/binaryObject/@characterSet</code>) [Optional] (N) (XPath <code>TEXPrintOrdChange/TPCXbody/TPCXitem/fabPrintOperation/refDoc/attachment/binaryObject/@characterSet</code>) [Optional] (Na)
<p>characterSetCode</p>	<p>the character set of an external document (examples UTF-8, UTF-16, Windows-1252, ISO-8859-7,...)</p> <ul style="list-style-type: none"> - base type: normalizedString, (XPath <code>TEXPrintOrdChange/TPCXbody/TPCXitem/refDoc/attachment/externalReference/characterSetCode</code>) 0-1 (N) (XPath <code>TEXPrintOrdChange/TPCXheader/refDoc/attachment/externalReference/characterSetCode</code>) 0-1 (N) (XPath <code>TEXPrintOrdChange/TPCXbody/TPCXitem/fabPrintOperation/refDoc/attachment/externalReference/characterSetCode</code>) 0-1 (N) (XPath <code>TEXPrintOrdChange/TPCXbody/TPCXitem/fabricComponent/refDoc/attachment/externalReference/characterSetCode</code>) 0-1 (N)
<p>city</p>	<p>name of the city (town, village)</p> <ul style="list-style-type: none"> - base type: string, max length: 40, (XPath <code>TEXPrintOrdChange/TPCXheader/thirdParty/city</code>) 0-1 (XPath <code>TEXPrintOrdChange/TPCXheader/subContractor/city</code>) 0-1 (XPath <code>TEXPrintOrdChange/TPCXbody/TPCXitem/thirdParty/city</code>) 0-1 (XPath <code>TEXPrintOrdChange/TPCXheader/buyer/city</code>) 0-1
<p>@codeList</p>	<p>it specifies the URL where the list of codes used to make an instance of the element can be found</p> <ul style="list-style-type: none"> - base type: string, max length: 255, (XPath <code>TEXPrintOrdChange/TPCXbody/TPCXitem/fabricComponent/note/@codeList</code>) [Optional] - nota: <i>must be used to provide (URL) the list of codes used in "noteLabel"</i> (XPath <code>TEXPrintOrdChange/TPCXbody/TPCXitem/dtScheme/note/@codeList</code>) [Optional] - nota: <i>must be used to provide (URL) the list of codes used in "noteLabel"</i> (XPath <code>TEXPrintOrdChange/TPCXbody/TPCXitem/fabricComponent/itemsList/qualityLevel/@codeList</code>) [Optional] (a) - nota: <i>at least one out of this attribute and "numberingOrg" should be set</i> (XPath <code>TEXPrintOrdChange/terms/allowanceCharge/dtScheme/note/@codeList</code>) [Optional] - nota: <i>must be used to provide (URL) the list of codes used in "noteLabel"</i> (XPath <code>TEXPrintOrdChange/terms/allowanceCharge/dtScheme/legalRef/@codeList</code>) [Optional] (a) (XPath <code>TEXPrintOrdChange/TPCXbody/TPCXitem/fabPrintOperation/note/@codeList</code>) [Optional] - nota: <i>must be used to provide (URL) the list of codes used in "noteLabel"</i> (XPath <code>TEXPrintOrdChange/TPCXbody/TPCXitem/fabricComponent/refDoc/season/@codeList</code>) [Optional] (a) - nota: <i>this attribute should be used either single or coupled with "listName" and "listVersion"</i> (XPath <code>TEXPrintOrdChange/TPCXheader/note/@codeList</code>) [Optional] - nota: <i>must be used to provide (URL) the list of codes used in "noteLabel"</i> (XPath <code>TEXPrintOrdChange/TPCXheader/refDoc/season/@codeList</code>) [Optional] (a)

	<p>- nota: <i>this attribute should be used either single or coupled with "listName" and "listVersion"</i> (XPath TEXPrintOrdChange/TPCXheader/season/@codeList) [Optional] (a)</p> <p>- nota: <i>this attribute should be used either single or coupled with "listName" and "listVersion"</i> (XPath TEXPrintOrdChange/TPCXbody/TPCXitem/dtScheme/legalRef/@codeList) [Optional] (XPath TEXPrintOrdChange/TPCXbody/TPCXitem/fabricProd/note/@codeList) [Optional]</p> <p>- nota: <i>must be used to provide (URL) the list of codes used in "noteLabel"</i> (XPath TEXPrintOrdChange/TPCXbody/TPCXitem/fabricComponent/texCode/art/@codeList) [Optional]</p> <p>- nota: <i>at least one out of this attribute and "numberingOrg" should be set</i> (XPath TEXPrintOrdChange/TPCXbody/TPCXitem/fabricComponent/texCode/pattern/@codeList) [Optional]</p> <p>- nota: <i>at least one out of this attribute and "numberingOrg" should be set</i> (XPath TEXPrintOrdChange/TPCXbody/TPCXitem/fabricProd/texCode/color/@codeList) [Optional]</p> <p>- nota: <i>this attribute should be used either single or coupled with "listName" and "listVersion"</i> (XPath TEXPrintOrdChange/TPCXbody/TPCXitem/refDoc/season/@codeList) [Optional] (a)</p> <p>- nota: <i>this attribute should be used either single or coupled with "listName" and "listVersion"</i> (XPath TEXPrintOrdChange/TPCXbody/TPCXitem/fabPrintOperation/refDoc/season/@codeList) [Optional] (a)</p> <p>- nota: <i>this attribute should be used either single or coupled with "listName" and "listVersion"</i> (XPath TEXPrintOrdChange/TPCXbody/TPCXitem/fabricProd/texCode/pattern/@codeList) [Optional]</p> <p>- nota: <i>at least one out of this attribute and "numberingOrg" should be set</i> (XPath TEXPrintOrdChange/TPCXbody/TPCXitem/fabricProd/texCode/art/@codeList) [Optional]</p> <p>- nota: <i>at least one out of this attribute and "numberingOrg" should be set</i> (XPath TEXPrintOrdChange/TPCXbody/TPCXitem/fabricComponent/texCode/color/@codeList) [Optional]</p> <p>- nota: <i>this attribute should be used either single or coupled with "listName" and "listVersion"</i></p>
color	<p>colour number of the product, when not included in the model or fabric code - base type: string, max length: 15, (XPath TEXPrintOrdChange/TPCXbody/TPCXitem/fabricComponent/texCode/color) 0-1 (XPath TEXPrintOrdChange/TPCXbody/TPCXitem/fabricProd/texCode/color) 0-1</p>
country	<p>code of the nation - base type: string, cod. table: T10 http://www.ebiz.enea.it/moda-ml/repository/codelist/v2018-1/gc_T10.xml (XPath TEXPrintOrdChange/TPCXheader/thirdParty/country) 0-1 (XPath TEXPrintOrdChange/TPCXheader/buyer/country) 0-1 (XPath TEXPrintOrdChange/TPCXbody/TPCXitem/thirdParty/country) 0-1 (XPath TEXPrintOrdChange/TPCXheader/subContractor/country) 0-1</p>
@CTest	<p>indicates the need to execute a colour test before the operation - base type: string, cod. table: NT38 http://www.ebiz.enea.it/moda-ml/repository/codelist/v2018-1/gc_NT38.xml (XPath TEXPrintOrdChange/TPCXbody/TPCXitem/fabricProd/@CTest) [Optional]</p>

@currency	<p>currency in which a specified monetary data is expressed</p> <p>- base type: string, cod. table: T9 http://www.ebiz.enea.it/moda-ml/repository/codelist/v2018-1/gc_T9.xml (XPath TEXPrintOrdChange/TPCXbody/TPCXitem/price/@currency) [Optional] (a)</p> <p>- nota: <i>Currency referred by the price.</i> (XPath TEXPrintOrdChange/terms/allowanceCharge/AC_amount/@currency) [Optional] (a) (XPath TEXPrintOrdChange/terms/allowanceCharge/@currency) [Optional] (a)</p>
@CV	<p>coefficient of variation (CV) of a measurement</p> <p>- base type: decimal, (XPath TEXPrintOrdChange/TPCXbody/TPCXitem/fabricProd/fabricSpecs/specValue/@CV) [Optional] (XPath TEXPrintOrdChange/TPCXbody/TPCXitem/fabPrintOperation/fabPrintSpecs/specValue/@CV) [Optional]</p>
@dateForm	<p>format used for the date</p> <p>- base type: string, cod. table: NT29 http://www.ebiz.enea.it/moda-ml/repository/codelist/v2018-1/gc_NT29.xml (XPath TEXPrintOrdChange/terms/transInfo/despatchDate/@dateForm) [Optional] (a) (XPath TEXPrintOrdChange/TPCXbody/TPCXitem/fabPrintOperation/refDoc/docDate/@dateForm) [Optional] (XPath TEXPrintOrdChange/TPCXbody/TPCXitem/refDoc/docDate/@dateForm) [Optional] (XPath TEXPrintOrdChange/TPCXheader/msgDate/@dateForm) [Optional] (XPath TEXPrintOrdChange/TPCXheader/refDoc/docDate/@dateForm) [Optional] (XPath TEXPrintOrdChange/TPCXbody/TPCXitem/fabricComponent/refDoc/docDate/@dateForm) [Optional] (XPath TEXPrintOrdChange/TPCXbody/TPCXitem/deliveryDate/@dateForm) [Optional] (XPath TEXPrintOrdChange/terms/transInfo/delEffectiveDate/@dateForm) [Optional]</p>
delEffectiveDate	<p>effective date of delivery of goods (declared in Despatch), according to one of the patterns YYYY-MM-DD, YYYY-MM-DD:HH-MM or YYYY-WW.</p> <p>- base type: string, (XPath TEXPrintOrdChange/terms/transInfo/delEffectiveDate) 0-1 (p)</p>
deliveryDate	<p>date of delivery of goods, requested or promised in the purchase process, according to one of the patterns YYYY-MM-DD, YYYY-MM-DD:HH-MM or YYYY-WW.</p> <p>- base type: string, (XPath TEXPrintOrdChange/TPCXbody/TPCXitem/deliveryDate) 0-1</p>
deliveryPlace	<p>place of delivery of goods, ultimate or related to a given leg</p> <p>- base type: string, max length: 250, (XPath TEXPrintOrdChange/terms/transInfo/deliveryPlace) 0-1 (U)</p>
dept	<p>name or code of a contact department within a Party</p> <p>- base type: string, max length: 40, (XPath TEXPrintOrdChange/TPCXheader/subContractor/dept) 0-1 (XPath TEXPrintOrdChange/TPCXbody/TPCXitem/thirdParty/dept) 0-1 (XPath TEXPrintOrdChange/TPCXheader/thirdParty/dept) 0-1 (XPath TEXPrintOrdChange/TPCXheader/buyer/dept) 0-1</p>
description	<p>free text description. The content of the element must be unique, it might be translated and repeated into more languages (thus no more than one instance for each language).</p> <p>- base type: string, max length: 250, (XPath TEXPrintOrdChange/TPCXbody/TPCXitem/fabricProd/texCode/description) 0-unbounded (AU) - note: <i>Product description</i></p>

	<p>(XPath TEXPrintOrdChange/TPCXbody/TPCXitem/fabricComponent/texCode/description) 0-unbounded (pAU) - note: <i>Product description</i></p>
despatchDate	<p>date of despatch of goods, requested or promised in the purchase process, according to one of the patterns YYYY-MM-DD, YYYY-MM-DD:HH-MM or YYYY-WW. - base type: string, (XPath TEXPrintOrdChange/terms/transInfo/despatchDate) 0-1 (N)</p>
despatchPlace	<p>place of despatch of goods, origin or related to a given leg - base type: string, max length: 250, (XPath TEXPrintOrdChange/terms/transInfo/despatchPlace) 0-1 (N)</p>
docDate	<p>date of issue of the referenced document, according to one of the patterns YYYY-MM-DD, YYYY-MM-DD:HH-MM or YYYY-WW. - base type: string, (XPath TEXPrintOrdChange/TPCXbody/TPCXitem/refDoc/docDate) 0-1 (XPath TEXPrintOrdChange/TPCXbody/TPCXitem/fabricComponent/refDoc/docDate) 0-1 (XPath TEXPrintOrdChange/TPCXbody/TPCXitem/fabPrintOperation/refDoc/docDate) 0-1 (XPath TEXPrintOrdChange/TPCXheader/refDoc/docDate) 0-1</p>
docID	<p>identification number of the referenced document SINCE 2008-1 ITS USE IN THE HEADER IS DISCOURAGED (REPLACED BY msgID) - base type: string, max length: 80, (XPath TEXPrintOrdChange/TPCXbody/TPCXitem/fabPrintOperation/refDoc/docID) 1-2 (p)</p> <hr/> <p>AAAA-WARNING! - text not AVAILABLE n. 245 - In=en (XPath TEXPrintOrdChange/TPCXheader/docID) 0-1 (XPath TEXPrintOrdChange/TPCXbody/TPCXitem/refDoc/docID) 1-2 (p)</p> <hr/> <p>AAAA-WARNING! - text not AVAILABLE n. 245 - In=en (XPath TEXPrintOrdChange/TPCXheader/refDoc/docID) 1-2 (p)</p> <hr/> <p>AAAA-WARNING! - text not AVAILABLE n. 245 - In=en (XPath TEXPrintOrdChange/TPCXbody/TPCXitem/fabricComponent/refDoc/docID) 1-2 (p)</p> <hr/> <p>AAAA-WARNING! - text not AVAILABLE n. 245 - In=en</p>
@docType	<p>type or class to which the referenced document belongs - base type: string, cod. table: T21 http://www.ebiz.enea.it/moda-ml/repository/codelist/v2018-1/gc_T21.xml (XPath TEXPrintOrdChange/TPCXheader/refDoc/@docType) [Required] (XPath TEXPrintOrdChange/TPCXbody/TPCXitem/fabPrintOperation/refDoc/@docType) [Required] (XPath TEXPrintOrdChange/TPCXbody/TPCXitem/fabricComponent/refDoc/@docType) [Required] (XPath TEXPrintOrdChange/TPCXbody/TPCXitem/refDoc/@docType) [Required]</p>
dyeN	<p>number of the dyeing batch of a textile product - base type: string, max length: 15, (XPath TEXPrintOrdChange/TPCXbody/TPCXitem/fabricProduction/pieceChain/dyeN) 0-1 (XPath TEXPrintOrdChange/TPCXbody/TPCXitem/fabricProduction/piece/dyeN) 0-1</p>

dyeStuff	<p>dye stuff used in the fabric dye process</p> <p>- base type: string, cod. table: T16</p> <p>http://www.ebiz.enea.it/moda-ml/repository/codelist/v2018-1/gc_T16.xml</p> <p>(XPath TEXPrintOrdChange/TPCXbody/TPCXitem/fabPrintOperation/dyeStuff) 0-1</p>
@email	<p>electronic mail address of the contact person within a Party</p> <p>- base type: string, max length: 250,</p> <p>(XPath TEXPrintOrdChange/TPCXbody/TPCXitem/thirdParty/person/@email) [Optional]</p> <p>(XPath TEXPrintOrdChange/TPCXheader/buyer/person/@email) [Optional]</p> <p>(XPath TEXPrintOrdChange/TPCXheader/thirdParty/person/@email) [Optional]</p> <p>(XPath TEXPrintOrdChange/TPCXheader/subContractor/person/@email) [Optional]</p>
@encoding	<p>specifies the decoding algorithm of the binary object</p> <p>- base type: normalizedString,</p> <p>(XPath TEXPrintOrdChange/TPCXbody/TPCXitem/refDoc/attachment/binaryObject/@encoding) [Optional] (Na)</p> <p>(XPath TEXPrintOrdChange/TPCXbody/TPCXitem/fabricComponent/refDoc/attachment/binaryObject/@encoding) [Optional] (Na)</p> <p>(XPath TEXPrintOrdChange/TPCXbody/TPCXitem/fabPrintOperation/refDoc/attachment/binaryObject/@encoding) [Optional] (Na)</p> <p>(XPath TEXPrintOrdChange/TPCXheader/refDoc/attachment/binaryObject/@encoding) [Optional] (N)</p>
encodingCode	<p>the encoding/decoding algorithm used with the external object (example is 'base64Binary')</p> <p>- base type: normalizedString,</p> <p>(XPath TEXPrintOrdChange/TPCXbody/TPCXitem/fabricComponent/refDoc/attachment/externalReference/encodingCode) 0-1 (N)</p> <p>(XPath TEXPrintOrdChange/TPCXbody/TPCXitem/refDoc/attachment/externalReference/encodingCode) 0-1 (N)</p> <p>(XPath TEXPrintOrdChange/TPCXheader/refDoc/attachment/externalReference/encodingCode) 0-1 (N)</p> <p>(XPath TEXPrintOrdChange/TPCXbody/TPCXitem/fabPrintOperation/refDoc/attachment/externalReference/encodingCode) 0-1 (N)</p>
@endUse	<p>specifies the final use of the fabric</p> <p>- base type: string, cod. table: NT4</p> <p>http://www.ebiz.enea.it/moda-ml/repository/codelist/v2018-1/gc_NT4.xml</p> <p>(XPath TEXPrintOrdChange/TPCXbody/TPCXitem/fabricProd/piece/@endUse) [Optional]</p>
EPC	<p>serial identifier used for tracing a physical item with RFID technology</p> <p>- base type: string,</p> <p>(XPath TEXPrintOrdChange/TPCXbody/TPCXitem/fabricProd/piece/EPC) 0-1</p> <p>- note: <i>the use of this element is DEPRECATED, use the appropriate elements (serialN)</i></p>
fabPrintChar	<p>code specifying a characteristic or parameter of the fabric printing</p> <p>- base type: string, cod. table: T45</p> <p>http://www.ebiz.enea.it/moda-ml/repository/codelist/v2018-1/gc_T45.xml</p> <p>(XPath TEXPrintOrdChange/TPCXbody/TPCXitem/fabPrintOperation/fabPrintSpecs/fabPrintChar) 1-1</p>
fabPrintCharText	<p>free text describing a characteristic or parameter of the fabric printing</p> <p>- base type: string, max length: 250,</p> <p>(XPath TEXPrintOrdChange/TPCXbody/TPCXitem/fabPrintOperation/fabPrintSpecs/fabPrintCharText) 1-1 (U)</p>

fabPrintTech	<p>operation technology used for fabric printing</p> <p>- base type: string, cod. table: T264 http://www.ebiz.enea.it/moda-ml/repository/codelist/v2018-1/gc_T264.xml (XPath TEXPrintOrdChange/TPCXbody/TPCXitem/fabPrintOperation/fabPrintTech) 1-1</p>
fabricChar	<p>code of the physical or mechanical parameter used to define a "technical characteristic of the fabric" (see Fabric technical sheet)</p> <p>- base type: string, cod. table: T13 http://www.ebiz.enea.it/moda-ml/repository/codelist/v2018-1/gc_T13.xml (XPath TEXPrintOrdChange/TPCXbody/TPCXitem/fabricProd/fabricSpecs/fabricChar) 1-1</p>
fabricCharText	<p>free text describing the physical or mechanical parameter used to define a "technical characteristic of the fabric"</p> <p>- base type: string, max length: 80, (XPath TEXPrintOrdChange/TPCXbody/TPCXitem/fabricProd/fabricSpecs/fabricCharText) 1-1 (U)</p>
fabricWidth	<p>width of the fabric as technical specification</p> <p>- base type: decimal, min inclusive: 0, fraction digits: 2, (XPath TEXPrintOrdChange/TPCXbody/TPCXitem/fabricProd/fabricWidth) 0-1</p>
@fax	<p>fax number of the contact person within a Party</p> <p>- base type: string, max length: 35, (XPath TEXPrintOrdChange/TPCXheader/buyer/person/@fax) [Optional] (XPath TEXPrintOrdChange/TPCXheader/subContractor/person/@fax) [Optional] (XPath TEXPrintOrdChange/TPCXbody/TPCXitem/thirdParty/person/@fax) [Optional] (XPath TEXPrintOrdChange/TPCXheader/thirdParty/person/@fax) [Optional]</p>
@fibre	<p>type of fibre used in a textile product</p> <p>- base type: string, cod. table: T19 http://www.ebiz.enea.it/moda-ml/repository/codelist/v2018-1/gc_T19.xml (XPath TEXPrintOrdChange/TPCXbody/TPCXitem/fabricProd/fabricCompos/percCompos/@fibre) [Required]</p>
fileName	<p>unique identifier (name) of the file</p> <p>- base type: string, max length: 255, (XPath TEXPrintOrdChange/TPCXheader/refDoc/attachment/fileName) 0-1 (N) (XPath TEXPrintOrdChange/TPCXbody/TPCXitem/refDoc/attachment/fileName) 0-1 (N) (XPath TEXPrintOrdChange/TPCXbody/TPCXitem/fabPrintOperation/refDoc/attachment/fileName) 0-1 (N) (XPath TEXPrintOrdChange/TPCXbody/TPCXitem/fabricComponent/refDoc/attachment/fileName) 0-1 (N)</p>
@finDiscount	<p>financial discount rate applied for payment by the date specified</p> <p>- base type: decimal, min inclusive: 0, max inclusive: 100, fraction digits: 2, (XPath TEXPrintOrdChange/terms/payment/@finDiscount) [Optional]</p>
@finSurcharge	<p>financial surcharge rate applied for payment after the date specified</p> <p>- base type: decimal, min inclusive: 0, max inclusive: 100, fraction digits: 2, (XPath TEXPrintOrdChange/terms/payment/@finSurcharge) [Optional]</p>
@format	<p>the format of the binary content (examples xml, pdf, doc,...)</p> <p>- base type: string, (XPath TEXPrintOrdChange/TPCXbody/TPCXitem/fabricComponent/refDoc/attachment/binaryObject/@format) [Optional] (Na) (XPath TEXPrintOrdChange/TPCXheader/refDoc/attachment/binaryObject/@format) [Optional] (N) (XPath TEXPrintOrdChange/TPCXbody/TPCXitem/refDoc/attachment/binaryObject/@format) [Optional] (Na)</p>

	(XPath TEXPrintOrdChange/TPCXbody/TPCXitem/fabPrintOperation/refDoc/attachment/binaryObject/@format) [Optional] (Na)
formatCode	the format of the external object (examples xml, pdf, doc,...) - base type: normalizedString, (XPath TEXPrintOrdChange/TPCXbody/TPCXitem/refDoc/attachment/externalReference/formatCode) 0-1 (N) (XPath TEXPrintOrdChange/TPCXheader/refDoc/attachment/externalReference/formatCode) 0-1 (N) (XPath TEXPrintOrdChange/TPCXbody/TPCXitem/fabPrintOperation/refDoc/attachment/externalReference/formatCode) 0-1 (N) (XPath TEXPrintOrdChange/TPCXbody/TPCXitem/fabricComponent/refDoc/attachment/externalReference/formatCode) 0-1 (N)
grossWeight	the gross weight, declared for transport or customs purpose - base type: decimal, min inclusive: 0, fraction digits: 2, (XPath TEXPrintOrdChange/TPCXbody/TPCXitem/fabricProd/piece/grossWeight) 0-1 - note: <i>gross Weight is related to the weight of the piece after packing.</i> (XPath TEXPrintOrdChange/terms/transInfo/grossWeight) 0-1
groundColor	ground colour related to a printing screen - base type: string, max length: 15, (XPath TEXPrintOrdChange/TPCXbody/TPCXitem/fabPrintOperation/groundColor) 0-9
id	primary identification code of a Party; it is recommended the format: nation code (ISO 3166) + VAT identification number (11 crt), with the qualifier "numberingOrg"= MF - base type: string, max length: 15, (XPath TEXPrintOrdChange/TPCXbody/TPCXitem/thirdParty/id) 1-1 (XPath TEXPrintOrdChange/TPCXheader/subContractor/id) 1-1 (XPath TEXPrintOrdChange/TPCXheader/buyer/id) 1-1 (p) (XPath TEXPrintOrdChange/TPCXheader/thirdParty/id) 1-1
@idQualifier	Qualification of the identifier. - base type: string, (XPath TEXPrintOrdChange/TPCXbody/TPCXitem/fabricProd/piece/serialN/@idQualifier) [Optional] (N) - nota: <i>this attribute should be used when the numberingOrg attribute is not enough to declare the type of serial identifier</i> (XPath TEXPrintOrdChange/TPCXbody/TPCXitem/fabricComponent/serialN/@idQualifier) [Optional] (N) - nota: <i>this attribute should be used when the numberingOrg attribute is not enough to declare the type of serial identifier</i> (XPath TEXPrintOrdChange/TPCXbody/TPCXitem/fabricProd/pieceChain/serialN/@idQualifier) [Optional] (N) - nota: <i>this attribute should be used when the numberingOrg attribute is not enough to declare the type of serial identifier</i> (XPath TEXPrintOrdChange/TPCXbody/TPCXitem/fabricProd/pieceChain/pieceCut/serialN/@idQualifier) [Optional] (N) - nota: <i>this attribute should be used when the numberingOrg attribute is not enough to declare the type of serial identifier</i> (XPath TEXPrintOrdChange/TPCXbody/TPCXitem/fabricComponent/itemsList/itemIdentification/serialN/@idQualifier) [Optional] (N) - nota: <i>this attribute should be used when the numberingOrg attribute is not enough to declare the type of serial identifier</i> (XPath TEXPrintOrdChange/TPCXheader/buyer/additionalIdentifier/@idQualifier) [Optional] (Na)

	- nota: <i>this attribute should be used when the numberingOrg attribute is not enough to declare the type of identifier</i>
incoTerm	specification of the terms of trade (INCOTERMS) - base type: string, cod. table: T3 http://www.ebiz.enea.it/moda-ml/repository/codelist/v2018-1/gc_T3.xml (XPath TEXPrintOrdChange/terms/trade/incoTerm) 1-1
incoTermText	free text specifying the terms of trade (incoterm, location) - base type: string, max length: 250, (XPath TEXPrintOrdChange/terms/trade/incoTermText) 1-1 (U)
@isCharge	Indicates if the element to which it refers is a charge (true = charge, false = allowance) - base type: boolean, min length: 0, (XPath TEXPrintOrdChange/terms/allowanceCharge/@isCharge) [Optional] (N)
@isURL	it indicates if the referred element is an URL (true) or not (false) - base type: boolean, (XPath TEXPrintOrdChange/TPCXbody/TPCXitem/fabricComponent/refDoc/attachment/externalReference/uri/@isURL) [Optional] [Default= true] (Na) - nota: <i>usage of URLs is recommended</i> (XPath TEXPrintOrdChange/TPCXheader/refDoc/attachment/externalReference/uri/@isURL) [Optional] [Default= true] (Na) - nota: <i>usage of URLs is recommended</i> (XPath TEXPrintOrdChange/TPCXbody/TPCXitem/fabPrintOperation/refDoc/attachment/externalReference/uri/@isURL) [Optional] [Default= true] (Na) - nota: <i>usage of URLs is recommended</i> (XPath TEXPrintOrdChange/TPCXbody/TPCXitem/refDoc/attachment/externalReference/uri/@isURL) [Optional] [Default= true] (Na) - nota: <i>usage of URLs is recommended</i>
itemID	number of the line/item of the referenced document - base type: string, max length: 40, (XPath TEXPrintOrdChange/TPCXbody/TPCXitem/refDoc/itemID) 0-1 (U) (XPath TEXPrintOrdChange/TPCXheader/refDoc/itemID) 0-1 (U) (XPath TEXPrintOrdChange/TPCXbody/TPCXitem/fabPrintOperation/refDoc/itemID) 0-1 (U) (XPath TEXPrintOrdChange/TPCXbody/TPCXitem/fabricComponent/refDoc/itemID) 0-1 (U)
legalName	legal name of a Party - base type: string, max length: 250, (XPath TEXPrintOrdChange/TPCXheader/buyer/legalName) 0-1 (U) (XPath TEXPrintOrdChange/TPCXheader/thirdParty/legalName) 0-1 (U) (XPath TEXPrintOrdChange/TPCXbody/TPCXitem/thirdParty/legalName) 0-1 (U) (XPath TEXPrintOrdChange/TPCXheader/subContractor/legalName) 0-1 (U)
legalRef	legal reference of the duty or tax or fee category - base type: string, (XPath TEXPrintOrdChange/TPCXbody/TPCXitem/dtScheme/legalRef) 0-1 (A) (XPath TEXPrintOrdChange/terms/allowanceCharge/dtScheme/legalRef) 0-1 (A)
lineN	number of the line item of the present message (xml document); it is set by the role that produces the document. Usually it is a progressive number, but not always. - base type: positiveInteger, min inclusive: 1, max inclusive: 9999, (XPath TEXPrintOrdChange/TPCXbody/TPCXitem/lineN) 1-1
@listName	the name of the list of codes used to make an instance of the element (it might be thought as descriptive element, i.e. 'fabric printing technologies', or not, i.e. "T264") - base type: string, max length: 40,

	<p>(XPath TEXPrintOrdChange/TPCXbody/TPCXitem/fabricComponent/texCode/art/@listName) [Optional] - nota: <i>this attribute should always be used coupled with “numberingOrg”</i> (XPath TEXPrintOrdChange/TPCXbody/TPCXitem/fabricComponent/refDoc/season/@listName) [Optional] (a) - nota: <i>this attribute should always be used coupled with “numberingOrg”</i> (XPath TEXPrintOrdChange/TPCXheader/season/@listName) [Optional] (a) - nota: <i>this attribute should always be used coupled with “numberingOrg”</i> (XPath TEXPrintOrdChange/TPCXheader/refDoc/season/@listName) [Optional] (a) - nota: <i>this attribute should always be used coupled with “numberingOrg”</i> (XPath TEXPrintOrdChange/TPCXbody/TPCXitem/fabricComponent/itemsList/qualityLevel/@listName) [Optional] (a) - nota: <i>this attribute should always be used coupled with “numberingOrg”</i> (XPath TEXPrintOrdChange/TPCXbody/TPCXitem/dtScheme/legalRef/@listName) [Optional] - nota: <i>this attribute should always be used coupled with “numberingOrg”</i> (XPath TEXPrintOrdChange/terms/allowanceCharge/dtScheme/legalRef/@listName) [Optional] (a) - nota: <i>this attribute should always be used coupled with “numberingOrg”</i> (XPath TEXPrintOrdChange/TPCXbody/TPCXitem/fabricComponent/texCode/pattern/@listName) [Optional] - nota: <i>this attribute should always be used coupled with “numberingOrg”</i> (XPath TEXPrintOrdChange/TPCXbody/TPCXitem/fabPrintOperation/refDoc/season/@listName) [Optional] (a) - nota: <i>this attribute should always be used coupled with “numberingOrg”</i> (XPath TEXPrintOrdChange/TPCXbody/TPCXitem/fabricProd/texCode/pattern/@listName) [Optional] - nota: <i>this attribute should always be used coupled with “numberingOrg”</i> (XPath TEXPrintOrdChange/TPCXbody/TPCXitem/fabricComponent/texCode/color/@listName) [Optional] - nota: <i>this attribute should always be used coupled with “numberingOrg”</i> (XPath TEXPrintOrdChange/TPCXbody/TPCXitem/refDoc/season/@listName) [Optional] (a) - nota: <i>this attribute should always be used coupled with “numberingOrg”</i> (XPath TEXPrintOrdChange/TPCXbody/TPCXitem/fabricProd/texCode/art/@listName) [Optional] - nota: <i>this attribute should always be used coupled with “numberingOrg”</i> (XPath TEXPrintOrdChange/TPCXbody/TPCXitem/fabricProd/texCode/color/@listName) [Optional] - nota: <i>this attribute should always be used coupled with “numberingOrg”</i></p>
@listVersion	<p>it specifie the version of the list of codes used to make an instance of the element - base type: string, max length: 6, (XPath TEXPrintOrdChange/TPCXbody/TPCXitem/fabricComponent/refDoc/season/@listVersion) [Optional] (a) - nota: <i>this attribute should always be used coupled with “numberingOrg” and “listName”</i> (XPath TEXPrintOrdChange/TPCXbody/TPCXitem/fabricComponent/itemsList/qualityLevel/@listVersion) [Optional] (a) - nota: <i>this attribute should always be used coupled with “numberingOrg” and “listName”</i> (XPath TEXPrintOrdChange/TPCXheader/season/@listVersion) [Optional] (a) - nota: <i>this attribute should always be used coupled with “numberingOrg” and “listName”</i></p>

	<p>(XPath TEXPrintOrdChange/TPCXbody/TPCXitem/fabricComponent/texCode/art/@listVersion) [Optional] - nota: <i>this attribute should always be used coupled with “numberingOrg” and “listName”</i></p> <p>(XPath TEXPrintOrdChange/TPCXbody/TPCXitem/fabricComponent/texCode/color/@listVersion) [Optional] - nota: <i>this attribute should always be used coupled with “numberingOrg” and “listName”</i></p> <p>(XPath TEXPrintOrdChange/TPCXheader/refDoc/season/@listVersion) [Optional] (a) - nota: <i>this attribute should always be used coupled with “numberingOrg” and “listName”</i></p> <p>(XPath TEXPrintOrdChange/TPCXbody/TPCXitem/fabricComponent/texCode/pattern/@listVersion) [Optional] - nota: <i>this attribute should always be used coupled with “numberingOrg” and “listName”</i></p> <p>(XPath TEXPrintOrdChange/TPCXbody/TPCXitem/fabricProd/texCode/color/@listVersion) [Optional] - nota: <i>this attribute should always be used coupled with “numberingOrg” and “listName”</i></p> <p>(XPath TEXPrintOrdChange/TPCXbody/TPCXitem/fabPrintOperation/refDoc/season/@listVersion) [Optional] (a) - nota: <i>this attribute should always be used coupled with “numberingOrg” and “listName”</i></p> <p>(XPath TEXPrintOrdChange/TPCXbody/TPCXitem/dtScheme/legalRef/@listVersion) [Optional] - nota: <i>this attribute should always be used coupled with “numberingOrg” and “listName”</i></p> <p>(XPath TEXPrintOrdChange/TPCXbody/TPCXitem/refDoc/season/@listVersion) [Optional] (a) - nota: <i>this attribute should always be used coupled with “numberingOrg” and “listName”</i></p> <p>(XPath TEXPrintOrdChange/TPCXbody/TPCXitem/fabricProd/texCode/pattern/@listVersion) [Optional] - nota: <i>this attribute should always be used coupled with “numberingOrg” and “listName”</i></p> <p>(XPath TEXPrintOrdChange/terms/allowanceCharge/dtScheme/legalRef/@listVersion) [Optional] (a) - nota: <i>this attribute should always be used coupled with “numberingOrg” and “listName”</i></p> <p>(XPath TEXPrintOrdChange/TPCXbody/TPCXitem/fabricProd/texCode/art/@listVersion) [Optional] - nota: <i>this attribute should always be used coupled with “numberingOrg” and “listName”</i></p>
@ln	<p>Language code. - base type: string, cod. table: NT60 http://www.ebiz.enea.it/moda-ml/repository/codelist/v2018-1/gc_NT60.xml (XPath TEXPrintOrdChange/TPCXbody/TPCXitem/fabricProd/texCode/description/@ln) [Optional] (N) (XPath TEXPrintOrdChange/TPCXbody/TPCXitem/fabricComponent/texCode/description/@ln) [Optional] (N)</p>
location	<p>specification of a location - base type: string, max length: 40, (XPath TEXPrintOrdChange/TPCXbody/TPCXitem/fabricComponent/location) 0-1 - note: <i>it may be used to specify the location where lie the pieces that the Subcontractor must use for the commissioned work operation</i> (XPath TEXPrintOrdChange/terms/trade/location) 0-1</p>

	- note: <i>place to which the INCOTERM applies</i>
@logo	company logo (URL of the image jpeg or gif). It is recommended that the width of the image does not exceed 640 pixel. - base type: string, max length: 255, (XPath TEXPrintOrdChange/TPCXheader/buyer/@logo) [Optional]
lotN	lot number of a product or batch number of the raw material - base type: string, max length: 15, (XPath TEXPrintOrdChange/TPCXbody/TPCXitem/fabricProd/pieceChain/lotN) 0-1 (XPath TEXPrintOrdChange/TPCXbody/TPCXitem/fabricProd/piece/lotN) 0-2 - note: <i>The lotN instances must differ by value of the numberingOrg attribute</i>
@LRI	attribute usable to format a string according to a customized User rule (local rule) - base type: string, cod. table: NT3 http://www.ebiz.enea.it/moda-ml/repository/codelist/v2018-1/gc_NT3.xml (XPath TEXPrintOrdChange/TPCXbody/TPCXitem/fabricComponent/location/@LRI) [Optional] (XPath TEXPrintOrdChange/terms/trade/location/@LRI) [Optional]
@maxQty	maximum product quantity - base type: decimal, min inclusive: 0, fraction digits: 2, (XPath TEXPrintOrdChange/terms/allowanceCharge/@maxQty) [Optional] (N) - nota: <i>maximum quantity of product for the application of this allowance or charge</i>
@method	standard protocol or method employed in a test to evaluate a characteristic or a parameter - base type: string, max length: 80, (XPath TEXPrintOrdChange/TPCXbody/TPCXitem/fabricProd/fabricSpecs/specValue/@method) [Optional] (XPath TEXPrintOrdChange/TPCXbody/TPCXitem/fabPrintOperation/fabPrintSpecs/specValue/@method) [Optional]
@mime	the mime type of the binary object - base type: normalizedString, (XPath TEXPrintOrdChange/TPCXheader/refDoc/attachment/binaryObject/@mime) [Optional] (N) (XPath TEXPrintOrdChange/TPCXbody/TPCXitem/refDoc/attachment/binaryObject/@mime) [Optional] (Na) (XPath TEXPrintOrdChange/TPCXbody/TPCXitem/fabricComponent/refDoc/attachment/binaryObject/@mime) [Optional] (Na) (XPath TEXPrintOrdChange/TPCXbody/TPCXitem/fabPrintOperation/refDoc/attachment/binaryObject/@mime) [Optional] (Na)
mimeCode	mime type of the external object - base type: normalizedString, (XPath TEXPrintOrdChange/TPCXheader/refDoc/attachment/externalReference/mimeCode) 0-1 (N) <hr/> AAAA-WARNING! - text not AVAILABLE n. 245 - In=en (XPath TEXPrintOrdChange/TPCXbody/TPCXitem/refDoc/attachment/externalReference/mimeCode) 0-1 (N) <hr/> AAAA-WARNING! - text not AVAILABLE n. 245 - In=en (XPath TEXPrintOrdChange/TPCXbody/TPCXitem/fabricComponent/refDoc/attachment/externalReference/mimeCode) 0-1 (N) <hr/> AAAA-WARNING! - text not AVAILABLE n. 245 - In=en

	<p>(XPath TEXPrintOrdChange/TPCXbody/TPCXitem/fabPrintOperation/refDoc/attachment/externalReference/mimeCode) 0-1 (N)</p> <hr/> <p>AAAA-WARNING! - text not AVAILABLE n. 245 - In=en</p>
@minQty	<p>minimum product quantity - base type: decimal, min inclusive: 0, fraction digits: 2, (XPath TEXPrintOrdChange/terms/allowanceCharge/@minQty) [Optional] (a) - nota: <i>minimum quantity of product for the application of this allowance or charge</i></p>
mixMatch	<p>colour hue used for the match of garments - base type: string, max length: 15, (XPath TEXPrintOrdChange/TPCXbody/TPCXitem/fabricProd/piece/mixMatch) 0-1</p>
msgCurrency	<p>currency used to express the monetary amounts of the message - base type: string, cod. table: T9 http://www.ebiz.enea.it/moda-ml/repository/codelist/v2018-1/gc_T9.xml (XPath TEXPrintOrdChange/TPCXheader/msgCurrency) 0-1</p>
msgDate	<p>date of issue of the present message (xml document), according to one of the patterns YYYY-MM-DD, YYYY-MM-DD:HH-MM or YYYY-WW. - base type: string, (XPath TEXPrintOrdChange/TPCXheader/msgDate) 1-1</p>
@msgfunction	<p>function performed by the present message with regards to the transmission - base type: string, cod. table: NT18 http://www.ebiz.enea.it/moda-ml/repository/codelist/v2018-1/gc_NT18.xml (XPath TEXPrintOrdChange/@msgfunction) [Optional]</p>
msgID	<p>key identifier of the business document in the information system of the issuing Party. In case of more despatches of the same business document, it is unchanged. - base type: string, max length: 35, (XPath TEXPrintOrdChange/TPCXheader/msgID) 0-1</p>
msgN	<p>identification number given to the message (xml document) by its issuer. In case of more despatches of the same business document, it changes. - base type: string, max length: 35, (XPath TEXPrintOrdChange/TPCXheader/msgN) 1-1</p>
netWeight	<p>the net weight declared for transport or customs purpose - base type: decimal, min inclusive: 0, fraction digits: 2, (XPath TEXPrintOrdChange/terms/transInfo/netWeight) 0-1</p>
note	<p>free text or structured (computer processing) note. For note structuring use the attributes "noteLabel" and "codelist" - base type: string, max length: 350, (XPath TEXPrintOrdChange/TPCXbody/TPCXitem/fabricProd/note) 0-99 (XPath TEXPrintOrdChange/TPCXheader/note) 0-99 (XPath TEXPrintOrdChange/TPCXbody/TPCXitem/dtScheme/note) 0-99 (XPath TEXPrintOrdChange/TPCXbody/TPCXitem/fabPrintOperation/note) 0-99 (XPath TEXPrintOrdChange/terms/allowanceCharge/dtScheme/note) 0-99 (XPath TEXPrintOrdChange/TPCXbody/TPCXitem/fabricComponent/note) 0-99</p>
@noteLabel	<p>subject qualifier of a note - base type: string, max length: 35, (XPath TEXPrintOrdChange/TPCXbody/TPCXitem/fabricComponent/note/@noteLabel) [Optional] - nota: <i>must be used to qualify the subject of the note</i> (XPath TEXPrintOrdChange/terms/allowanceCharge/dtScheme/note/@noteLabel) [Optional]</p>

	<p>- nota: <i>must be used to qualify the subject of the note</i> (XPath <code>TEXPrintOrdChange/TPCXbody/TPCXitem/dtScheme/note/@noteLabel</code>) [Optional]</p> <p>- nota: <i>must be used to qualify the subject of the note</i> (XPath <code>TEXPrintOrdChange/TPCXheader/note/@noteLabel</code>) [Optional]</p> <p>- nota: <i>must be used to qualify the subject of the note</i> (XPath <code>TEXPrintOrdChange/TPCXbody/TPCXitem/fabPrintOperation/note/@noteLabel</code>) [Optional]</p> <p>- nota: <i>must be used to qualify the subject of the note</i> (XPath <code>TEXPrintOrdChange/TPCXbody/TPCXitem/fabricProd/note/@noteLabel</code>) [Optional]</p> <p>- nota: <i>must be used to qualify the subject of the note</i></p>
<p>@numberingOrg</p>	<p>code specifying the organisation who has created or owns the coding or numbering system</p> <p>- base type: string, cod. table: NT6 http://www.ebiz.enea.it/moda-ml/repository/codelist/v2018-1/gc_NT6.xml (XPath <code>TEXPrintOrdChange/TPCXbody/TPCXitem/fabricComponent/refDoc/season/@numberingOrg</code>) [Optional] (a)</p> <p>- nota: <i>this attribute should be used either single or coupled with "listName" and "listVersion"</i> (XPath <code>TEXPrintOrdChange/TPCXbody/TPCXitem/fabricProd/piece/mixMatch/@numberingOrg</code>) [Optional] (XPath <code>TEXPrintOrdChange/TPCXbody/TPCXitem/fabricProd/piece/packageN/@numberingOrg</code>) [Optional] (XPath <code>TEXPrintOrdChange/TPCXbody/TPCXitem/refDoc/docID/@numberingOrg</code>) [Optional]</p> <p>- nota: <i>here can be specified whose document numbering is used (e.g.: Client, Supplier, ..)</i> (XPath <code>TEXPrintOrdChange/TPCXbody/TPCXitem/fabricComponent/texCode/@numberingOrg</code>) [Optional] (XPath <code>TEXPrintOrdChange/TPCXbody/TPCXitem/fabPrintOperation/note/@numberingOrg</code>) [Optional]</p> <p>- nota: <i>must be used to specify the organization that created the list of codes used in "noteLabel"</i> (XPath <code>TEXPrintOrdChange/TPCXheader/refDoc/season/@numberingOrg</code>) [Optional] (a)</p> <p>- nota: <i>this attribute should be used either single or coupled with "listName" and "listVersion"</i> (XPath <code>TEXPrintOrdChange/TPCXbody/TPCXitem/fabricComponent/refDoc/attachment/fileName/@numberingOrg</code>) [Optional] (a) (XPath <code>TEXPrintOrdChange/TPCXheader/thirdParty/id/@numberingOrg</code>) [Optional] (XPath <code>TEXPrintOrdChange/TPCXheader/buyer/id/@numberingOrg</code>) [Optional] (XPath <code>TEXPrintOrdChange/TPCXheader/docID/@numberingOrg</code>) [Optional]</p> <p>- nota: <i>here can be specified whose document numbering is used (e.g.: Client, Supplier, ..)</i> (XPath <code>TEXPrintOrdChange/terms/allowanceCharge/dtScheme/note/@numberingOrg</code>) [Optional]</p> <p>- nota: <i>must be used to specify the organization that created the list of codes used in "noteLabel"</i> (XPath <code>TEXPrintOrdChange/TPCXbody/TPCXitem/fabricComponent/refDoc/docID/@numberingOrg</code>) [Optional]</p> <p>- nota: <i>here can be specified whose document numbering is used (e.g.: Client, Supplier, ..)</i> (XPath <code>TEXPrintOrdChange/TPCXbody/TPCXitem/thirdParty/id/@numberingOrg</code>) [Optional] (XPath <code>TEXPrintOrdChange/terms/allowanceCharge/legalRef/@numberingOrg</code>) [Optional] (a)</p> <p>- nota: <i>this attribute should be used either single or coupled with "listName" and "listVersion"</i></p>

	<p>(XPath TEXPrintOrdChange/TPCXheader/buyer/additionalIdentifier/@numberingOrg) [Optional] (a) - nota: <i>here the issuer of the identifier must be specified</i> (XPath TEXPrintOrdChange/TPCXbody/TPCXitem/fabricProd/ note/@numberingOrg) [Optional] - nota: <i>must be used to specify the organization that created the list of code s used in "noteLabel"</i> (XPath TEXPrintOrdChange/TPCXbody/TPCXitem/fabricProd/ piece/dyeN/@numberingOrg) [Optional] (XPath TEXPrintOrdChange/TPCXbody/TPCXitem/fabricProd/ pieceChain/dyeN/@numberingOrg) [Optional] (XPath TEXPrintOrdChange/TPCXheader/refDoc/attachment/ fileName/@numberingOrg) [Optional] (XPath TEXPrintOrdChange/TPCXbody/TPCXitem/fabricProd/ pieceChain/lotN/@numberingOrg) [Optional] (XPath TEXPrintOrdChange/TPCXbody/TPCXitem/fabricProd/ texCode/color/@numberingOrg) [Optional] - nota: <i>this attribute should be used either single or coupled with "listName" and "listVersion"</i> (XPath TEXPrintOrdChange/TPCXheader/note/@numberingOrg) [Optional] - nota: <i>must be used to specify the organization that created the list of code s used in "noteLabel"</i> (XPath TEXPrintOrdChange/TPCXheader/subContractor/id/@numberingOrg) [Optio nal] (XPath TEXPrintOrdChange/TPCXbody/TPCXitem/fabricProd/ pieceChain/packageN/@numberingOrg) [Optional] (XPath TEXPrintOrdChange/TPCXbody/TPCXitem/fabricComponent/texCode/added /@numberingOrg) [Optional] - nota: <i>this attribute should be used either single or coupled with "listName" and "listVersion"</i> (XPath TEXPrintOrdChange/TPCXbody/TPCXitem/fabPrintOperation/refDoc/season /@numberingOrg) [Optional] (a) - nota: <i>this attribute should be used either single or coupled with "listName" and "listVersion"</i> (XPath TEXPrintOrdChange/TPCXheader/season/@numberingOrg) [Optional] (a) - nota: <i>this attribute should be used either single or coupled with "listName" and "listVersion"</i> (XPath TEXPrintOrdChange/TPCXbody/TPCXitem/fabricComponent/itemsList/itemI dentification/serialN/@numberingOrg) [Optional] - nota: <i>here the issuer of the serial number must be specified (when differen t from the Supplier)</i> (XPath TEXPrintOrdChange/TPCXbody/TPCXitem/fabricComponent/itemsList/qualit yLevel/@numberingOrg) [Optional] (a) - nota: <i>this attribute should be used either single or coupled with "listName" and "listVersion"</i> (XPath TEXPrintOrdChange/TPCXbody/TPCXitem/fabPrintOperation/groundColor/ @numberingOrg) [Optional] (XPath TEXPrintOrdChange/TPCXbody/TPCXitem/fabricProd/ pieceChain/serialN/@numberingOrg) [Optional] - nota: <i>here the issuer of the serial number must be specified (when differen t from the Supplier)</i> (XPath TEXPrintOrdChange/TPCXbody/TPCXitem/fabricProd/ texCode/added/@numberingOrg) [Optional] - nota: <i>this attribute should be used either single or coupled with "listName" and "listVersion"</i> (XPath TEXPrintOrdChange/TPCXbody/TPCXitem/fabricComponent/serialN/@num beringOrg) [Optional]</p>
--	---

- nota: *here the issuer of the serial number must be specified (when different from the Supplier)*
(XPath
 TEXPrintOrdChange/TPCXbody/TPCXitem/fabPrintOperation/refDoc/docID/
 @numberingOrg) [Optional]

- nota: *here can be specified whose document numbering is used (e.g.: Client, Supplier, ..)*
(XPath TEXPrintOrdChange/TPCXbody/TPCXitem/dtScheme/
 legalRef/@numberingOrg) [Optional]

- nota: *this attribute should be used either single or coupled with "listName" and "listVersion"*
(XPath TEXPrintOrdChange/TPCXbody/TPCXitem/refDoc/
 attachment/fileName/@numberingOrg) [Optional] (a)

(XPath
 TEXPrintOrdChange/TPCXbody/TPCXitem/fabricComponent/texCode/pattern/
 @numberingOrg) [Optional]

- nota: *this attribute should be used either single or coupled with "listName" and "listVersion"*
(XPath TEXPrintOrdChange/TPCXheader/refDoc/docID/@numberingOrg) [Optional]

- nota: *here can be specified whose document numbering is used (e.g.: Client, Supplier, ..)*
(XPath TEXPrintOrdChange/TPCXbody/TPCXitem/fabricProd/
 piece/lotN/@numberingOrg) [Optional]

(XPath TEXPrintOrdChange/TPCXbody/TPCXitem/refDoc/season/
 @numberingOrg) [Optional] (a)

- nota: *this attribute should be used either single or coupled with "listName" and "listVersion"*
(XPath
 TEXPrintOrdChange/TPCXbody/TPCXitem/fabPrintOperation/refDoc/attach
 ment/fileName/@numberingOrg) [Optional] (a)

(XPath
 TEXPrintOrdChange/TPCXbody/TPCXitem/fabricComponent/texCode/art/
 @numberingOrg) [Optional]

- nota: *this attribute should be used either single or coupled with "listName" and "listVersion"*
(XPath TEXPrintOrdChange/TPCXbody/TPCXitem/fabricProd/
 piece/EPC/@numberingOrg) [Optional]

(XPath
 TEXPrintOrdChange/TPCXbody/TPCXitem/fabricComponent/texCode/color/
 @numberingOrg) [Optional]

- nota: *this attribute should be used either single or coupled with "listName" and "listVersion"*
(XPath TEXPrintOrdChange/TPCXbody/TPCXitem/dtScheme/note/
 @numberingOrg) [Optional]

- nota: *must be used to specify the organization that created the list of codes used in "noteLabel"*
(XPath TEXPrintOrdChange/TPCXbody/TPCXitem/fabricProd/
 texCode/pattern/@numberingOrg) [Optional]

- nota: *this attribute should be used either single or coupled with "listName" and "listVersion"*
(XPath TEXPrintOrdChange/TPCXbody/TPCXitem/fabricProd/
 pieceChain/pieceCut/serialN/@numberingOrg) [Optional]

- nota: *here the issuer of the serial number must be specified (when different from the Supplier)*
(XPath
 TEXPrintOrdChange/TPCXbody/TPCXitem/fabricComponent/note/
 @numberingOrg) [Optional]

- nota: *must be used to specify the organization that created the list of codes used in "noteLabel"*
(XPath TEXPrintOrdChange/TPCXbody/TPCXitem/fabricProd/
 piece/serialN/@numberingOrg) [Optional]

- nota: *here the issuer of the serial number must be specified (when different from the Supplier)*
(XPath TEXPrintOrdChange/TPCXbody/TPCXitem/fabricProd/
 texCode/art/@numberingOrg) [Optional]

	<p>- nota: <i>this attribute should be used either single or coupled with "listName" and "listVersion"</i></p> <p>(XPath TEXPrintOrdChange/TPCXbody/TPCXitem/fabricProd/texCode/@numberingOrg) [Optional]</p>
@packageContainerN	<p>reference usable to indicate the outer package containing this package</p> <p>- base type: string, max length: 40,</p> <p>(XPath TEXPrintOrdChange/TPCXbody/TPCXitem/fabricProd/piece/packageN/@packageContainerN) [Optional]</p> <p>(XPath TEXPrintOrdChange/TPCXbody/TPCXitem/fabricProd/pieceChain/packageN/@packageContainerN) [Optional]</p>
packageN	<p>serial number used to identify a transport package</p> <p>- base type: string, max length: 40,</p> <p>(XPath TEXPrintOrdChange/TPCXbody/TPCXitem/fabricProd/piece/packageN) 0-1 (U)</p> <p>- note: <i>here the transport package containing the piece can be identified</i></p> <p>(XPath TEXPrintOrdChange/TPCXbody/TPCXitem/fabricProd/pieceChain/packageN) 0-1 (U)</p>
@part	<p>percent fraction of a total payment</p> <p>- base type: decimal, min inclusive: 1, max inclusive: 99, fraction digits: 2,</p> <p>(XPath TEXPrintOrdChange/terms/insPayment/@part) [Required]</p> <p>- nota: <i>here the % value of each installment must be indicated</i></p>
pattern	<p>pattern/design number of the product, when not included in the article code</p> <p>- base type: string, max length: 15,</p> <p>(XPath TEXPrintOrdChange/TPCXbody/TPCXitem/fabricProd/texCode/pattern) 0-1</p> <p>(XPath TEXPrintOrdChange/TPCXbody/TPCXitem/fabricComponent/texCode/pattern) 0-1</p>
payMode	<p>way or means of payment</p> <p>- base type: string, cod. table: T2</p> <p>http://www.ebiz.enea.it/moda-ml/repository/codelist/v2018-1/gc_T2.xml</p> <p>(XPath TEXPrintOrdChange/terms/insPayment/payMode) 0-1</p> <p>(XPath TEXPrintOrdChange/terms/payment/payMode) 0-1</p>
payTerm	<p>code specifying the terms or time by which the payment must be done</p> <p>- base type: string, cod. table: T1</p> <p>http://www.ebiz.enea.it/moda-ml/repository/codelist/v2018-1/gc_T1.xml</p> <p>(XPath TEXPrintOrdChange/terms/insPayment/payTerm) 1-1</p> <p>(XPath TEXPrintOrdChange/terms/payment/payTerm) 1-1</p>
payTermText	<p>free text specifying the terms by which the payment must be done (time/mode or means)</p> <p>- base type: string, max length: 250,</p> <p>(XPath TEXPrintOrdChange/terms/insPayment/payTermText) 1-1 (U)</p> <p>(XPath TEXPrintOrdChange/terms/payment/payTermText) 1-1 (U)</p>
pcTolerance	<p>percent deviation tolerated on the value of a measurement (it must have a plus or minus sign)</p> <p>- base type: decimal, min inclusive: 0, max inclusive: 100, total digits: 2,</p> <p>(XPath TEXPrintOrdChange/TPCXbody/TPCXitem/fabricProd/fabricSpecs/pcTolerance) 0-2</p>
percCompos	<p>fiber rate in the product composition</p> <p>- base type: decimal, min inclusive: 0, max inclusive: 100, fraction digits: 2,</p> <p>(XPath TEXPrintOrdChange/TPCXbody/TPCXitem/fabricProd/fabricCompos/percCompos) 1-9</p>
person	<p>name of the contact person within a Party</p> <p>- base type: string, max length: 40,</p> <p>(XPath TEXPrintOrdChange/TPCXheader/thirdParty/person) 0-1</p> <p>(XPath TEXPrintOrdChange/TPCXbody/TPCXitem/thirdParty/person) 0-1</p> <p>(XPath TEXPrintOrdChange/TPCXheader/buyer/person) 0-1</p>

	(XPath TEXPrintOrdChange/TPCXheader/subContractor/person) 0-1
@phone	phone number of the contact person within a Party - base type: string, max length: 35, (XPath TEXPrintOrdChange/TPCXheader/buyer/person/@phone) [Optional] (XPath TEXPrintOrdChange/TPCXbody/TPCXitem/thirdParty/person/@phone) [Optional] (XPath TEXPrintOrdChange/TPCXheader/subContractor/person/@phone) [Optional] (XPath TEXPrintOrdChange/TPCXheader/thirdParty/person/@phone) [Optional]
pieceAllow	allowance required or accorded for the piece - base type: decimal, fraction digits: 2, (XPath TEXPrintOrdChange/TPCXbody/TPCXitem/fabricProd/piece/pieceAllow) 0-1
pieceCutWidth	effective usable width of the fabric piece (for garment manufacturing) - base type: decimal, min inclusive: 0, fraction digits: 2, (XPath TEXPrintOrdChange/TPCXbody/TPCXitem/fabricProd/piece/pieceCutWidth) 0-1
pieceInnWrap1	code specifying the type of inner wrapping/packing used for the fabric piece - base type: string, cod. table: T4 http://www.ebiz.enea.it/moda-ml/repository/codelist/v2018-1/gc_T4.xml (XPath TEXPrintOrdChange/TPCXbody/TPCXitem/fabricProd/piece/piecePack/pieceInnWrap1) 1-1 (XPath TEXPrintOrdChange/TPCXbody/TPCXitem/fabricProd/pieceChain/piecePack/pieceInnWrap1) 1-1
pieceInnWrap2	code sub-specifying the type of inner wrapping/packing used for the fabric piece - base type: string, cod. table: T5 http://www.ebiz.enea.it/moda-ml/repository/codelist/v2018-1/gc_T5.xml (XPath TEXPrintOrdChange/TPCXbody/TPCXitem/fabricProd/pieceChain/piecePack/pieceInnWrap2) 0-1 (XPath TEXPrintOrdChange/TPCXbody/TPCXitem/fabricProd/piece/piecePack/pieceInnWrap2) 0-1
pieceLength	length of the piece - base type: decimal, min inclusive: 0, fraction digits: 2, (XPath TEXPrintOrdChange/TPCXbody/TPCXitem/fabricProd/pieceChain/pieceCut/pieceLength) 0-1 (XPath TEXPrintOrdChange/TPCXbody/TPCXitem/fabricProd/piece/pieceLength) 0-1 (XPath TEXPrintOrdChange/TPCXbody/TPCXitem/fabricProd/pieceChain/pieceLength) 0-1
pieceOutWrap	code specifying the type of outer wrapping or packing used for the fabric piece - base type: string, cod. table: T6 http://www.ebiz.enea.it/moda-ml/repository/codelist/v2018-1/gc_T6.xml (XPath TEXPrintOrdChange/TPCXbody/TPCXitem/fabricProd/piece/piecePack/pieceOutWrap) 0-1 (XPath TEXPrintOrdChange/TPCXbody/TPCXitem/fabricProd/pieceChain/piecePack/pieceOutWrap) 0-1
piecePackText	free text specifying the type of wrapping or packing used for the fabric piece - base type: string, max length: 250, (XPath TEXPrintOrdChange/TPCXbody/TPCXitem/fabricProd/pieceChain/piecePack/piecePackText) 1-1 (U) (XPath TEXPrintOrdChange/TPCXbody/TPCXitem/fabricProd/piece/piecePack/piecePackText) 1-1 (U)
pieceStatus	code used to describe the status of a fabric piece after the control - base type: string, cod. table: T52 http://www.ebiz.enea.it/moda-ml/repository/codelist/v2018-1/gc_T52.xml (XPath TEXPrintOrdChange/TPCXbody/TPCXitem/fabricProd/piece/pieceStatus) 0-1

pieceWeight	<p>effective total weight of the fabric piece</p> <ul style="list-style-type: none"> - base type: decimal, min inclusive: 0, fraction digits: 2, (XPath TEXPrintOrdChange/TPCXbody/TPCXitem/fabricProd/piece/pieceWeight) 0-1 - note: <i>It is the net weight of the piece.</i> (XPath TEXPrintOrdChange/TPCXbody/TPCXitem/fabricProd/pieceChain/pieceWeight) 0-1 (XPath TEXPrintOrdChange/TPCXbody/TPCXitem/fabricProd/pieceChain/pieceCut/pieceWeight) 0-1
pieceWeightM	<p>effective weight per metre of the fabric piece</p> <ul style="list-style-type: none"> - base type: decimal, min inclusive: 0, fraction digits: 2, (XPath TEXPrintOrdChange/TPCXbody/TPCXitem/fabricProd/piece/pieceWeightM) 0-1
pieceWidth	<p>effective width of the fabric piece</p> <ul style="list-style-type: none"> - base type: decimal, min inclusive: 0, fraction digits: 2, (XPath TEXPrintOrdChange/TPCXbody/TPCXitem/fabricProd/piece/pieceWidth) 0-1 (XPath TEXPrintOrdChange/TPCXbody/TPCXitem/fabricProd/pieceChain/pieceWidth) 0-1
postCode	<p>code defining the postal zone</p> <ul style="list-style-type: none"> - base type: string, max length: 10, (XPath TEXPrintOrdChange/TPCXheader/subContractor/postCode) 0-1 (XPath TEXPrintOrdChange/TPCXbody/TPCXitem/thirdParty/postCode) 0-1 (XPath TEXPrintOrdChange/TPCXheader/thirdParty/postCode) 0-1 (XPath TEXPrintOrdChange/TPCXheader/buyer/postCode) 0-1
price	<p>unit price of the article, object or service specified</p> <ul style="list-style-type: none"> - base type: decimal, min inclusive: 0, fraction digits: 4, (XPath TEXPrintOrdChange/TPCXbody/TPCXitem/price) 0-1 (AU)
@priceQualifier	<p>type of price with reference to discount and taxes</p> <ul style="list-style-type: none"> - base type: string, cod. table: NT20 http://www.ebiz.enea.it/moda-ml/repository/codelist/v2018-1/gc_NT20.xml (XPath TEXPrintOrdChange/TPCXbody/TPCXitem/price/@priceQualifier) [Optional] [Default= NET]
@productLevel	<p>level of the product (end or intermediate) yielded by an operation in a work cycle</p> <ul style="list-style-type: none"> - base type: string, cod. table: NT22 http://www.ebiz.enea.it/moda-ml/repository/codelist/v2018-1/gc_NT22.xml (XPath TEXPrintOrdChange/TPCXbody/TPCXitem/@productLevel) [Optional] [Default= END] - nota: <i>this qualifier "intermediate" must be used when the product is also a component in an other line of the same Commission Order</i>
@progr	<p>progressive number in the sequence</p> <ul style="list-style-type: none"> - base type: positiveInteger, min inclusive: 1, (XPath TEXPrintOrdChange/terms/transInfo/@progr) [Optional] (N) - nota: <i>Indicates the position of the leg in a sequence of transport legs. If it is declared it must be in all the transInfo elements.</i>
qty	<p>net quantity of the article or object correlated, qualified by the function of the document (ordering, delivering, ..) and by the context</p> <ul style="list-style-type: none"> - base type: decimal, min inclusive: 0, fraction digits: 2, (XPath TEXPrintOrdChange/TPCXbody/TPCXitem/qty) 0-3 (XPath TEXPrintOrdChange/TPCXbody/TPCXitem/fabricComponent/qty) 1-3 - note: <i>quantity to be consumed in the transformation. This element can have more instances only if the units of measure are different</i>
qualityLevel	<p>the product quality level (first choice, second choice, ...).</p> <ul style="list-style-type: none"> - base type: string,

	(XPath TEXPrintOrdChange/TPCXbody/TPCXitem/fabricComponent/itemsList/qualityLevel) 0-1 (N)
@role	Third Party role qualifier - base type: string, cod. table: NT2 http://www.ebiz.enea.it/moda-ml/repository/codelist/v2018-1/gc_NT2.xml (XPath TEXPrintOrdChange/TPCXheader/thirdParty/@role) [Required] (XPath TEXPrintOrdChange/TPCXbody/TPCXitem/thirdParty/@role) [Required]
@screenN	identification number of a printing screen - base type: positiveInteger, (XPath TEXPrintOrdChange/TPCXbody/TPCXitem/fabPrintOperation/groundColor/@screenN) [Required]
season	sale season; defined as: season (1 crt) + year (4 crt) - season: S/S=1 A/W=2 Spring=3 Summer=4 Autumn=5 Winter=6: for more than four seasons use alphabetic sequence: 1st season=A 2nd season=B etc.etc. - base type: string, max length: 15, (XPath TEXPrintOrdChange/TPCXbody/TPCXitem/refDoc/season) 0-1 (A) - note: here indicates the season to which the referenced document belongs (XPath TEXPrintOrdChange/TPCXheader/refDoc/season) 0-1 (A) - note: here indicates the season to which the referenced document belongs (XPath TEXPrintOrdChange/TPCXbody/TPCXitem/fabPrintOperation/refDoc/season) 0-1 (A) - note: here indicates the season to which the referenced document belongs (XPath TEXPrintOrdChange/TPCXbody/TPCXitem/fabricComponent/refDoc/season) 0-1 (A) - note: here indicates the season to which the referenced document belongs (XPath TEXPrintOrdChange/TPCXheader/season) 0-1 (A)
@sender	qualifier that specifies the Party issuing of the document - base type: boolean, (XPath TEXPrintOrdChange/TPCXheader/buyer/@sender) [Optional] (a*) - nota: This attribute is mandatory when the STYLESHEET must be used (XPath TEXPrintOrdChange/TPCXheader/thirdParty/@sender) [Optional] (a*) - nota: This attribute is mandatory when the STYLESHEET must be used (XPath TEXPrintOrdChange/TPCXheader/subContractor/@sender) [Optional] (a*) - nota: This attribute is mandatory when the STYLESHEET must be used (XPath TEXPrintOrdChange/TPCXbody/TPCXitem/thirdParty/@sender) [Optional] (a*) - nota: This attribute is mandatory when the STYLESHEET must be used
serialN	serial number used for the identification of a physical unit - base type: string, max length: 250, (XPath TEXPrintOrdChange/TPCXbody/TPCXitem/fabricComponent/serialN) 0-unbounded (AU) - note: it may be used to identify the pieces/chains that the Subcontractor must use for the commissioned work (XPath TEXPrintOrdChange/TPCXbody/TPCXitem/fabricProd/pieceChain/serialN) 1-9 (AU) - note: multiple values of serialN are allowed in order to provide different representations of the serial identifier of the same piece chain. Different instances of serialN must differ at least for one value of idQualifier or numberingOrg (XPath TEXPrintOrdChange/TPCXbody/TPCXitem/fabricProd/pieceChain/pieceCut/serialN) 1-9 (AU) - note: multiple values of serialN are allowed in order to provide different representations of the serial identifier of the same piece. Different instances of serialN must differ at least for one value of idQualifier or numberingOrg

	<p>(XPath TEXPrintOrdChange/TPCXbody/TPCXitem/fabricComponent/itemsList/itemI dentification/serialN) 1-9 (AU)</p> <hr/> <p>AAAA-WARNING! - text not AVAILABLE n. 245 - In=en - note: multiple values of serialN are allowed for different representations of the serial identifier of the same product unit. Instances of serialN must differ at least for one value of numberingOrg and idQua lifier.</p> <p>(XPath TEXPrintOrdChange/TPCXbody/TPCXitem/fabricProd/ piece/serialN) 0-9 (AU)</p> <hr/> <p>AAAA-WARNING! - text not AVAILABLE n. 245 - In=en - note: multiple values of serialN are allowed for different representations of the serial identifier of the same piece. Instances of serialN must differ at least for one value of numberingOrg and idQualifier.</p>
@source	<p>party who has provided the data - base type: string, cod. table: NT12 http://www.ebiz.enea.it/moda-ml/repository/codelist/v2018-1/gc_NT12.xml (XPath TEXPrintOrdChange/TPCXbody/TPCXitem/fabricProd/ fabricSpecs/specValue/@source) [Optional] (XPath TEXPrintOrdChange/TPCXbody/TPCXitem/fabPrintOperation/fabPrintSpecs/ specValue/@source) [Optional]</p>
specValue	<p>value requested for a property or a parameter that is measured - base type: decimal, (XPath TEXPrintOrdChange/TPCXbody/TPCXitem/fabPrintOperation/fabPrintSpecs/ specValue) 0-1 (XPath TEXPrintOrdChange/TPCXbody/TPCXitem/fabricProd/ fabricSpecs/specValue) 0-1</p>
street	<p>street and building number identifying a location - base type: string, max length: 80, (XPath TEXPrintOrdChange/TPCXheader/thirdParty/street) 0-1 (XPath TEXPrintOrdChange/TPCXbody/TPCXitem/thirdParty/street) 0-1 (XPath TEXPrintOrdChange/TPCXheader/buyer/street) 0-1 (XPath TEXPrintOrdChange/TPCXheader/subContractor/street) 0-1</p>
subCountry	<p>short name or code of the sub-country entity - base type: string, max length: 9, (XPath TEXPrintOrdChange/TPCXbody/TPCXitem/thirdParty/subCountry) 0-1 (XPath TEXPrintOrdChange/TPCXheader/thirdParty/subCountry) 0-1 (XPath TEXPrintOrdChange/TPCXheader/subContractor/subCountry) 0-1 (XPath TEXPrintOrdChange/TPCXheader/buyer/subCountry) 0-1</p>
subDept	<p>name or code of a contact department within a Party - base type: string, max length: 40, (XPath TEXPrintOrdChange/TPCXheader/subContractor/subDept) 0-1 (N) (XPath TEXPrintOrdChange/TPCXheader/buyer/subDept) 0-1 (N) (XPath TEXPrintOrdChange/TPCXheader/thirdParty/subDept) 0-1 (N) (XPath TEXPrintOrdChange/TPCXbody/TPCXitem/thirdParty/subDept) 0-1 (N)</p>
taxCategory	<p>duty or tax or fee category - base type: string, cod. table: T62 http://www.ebiz.enea.it/moda-ml/repository/codelist/v2018-1/gc_T62.xml (XPath TEXPrintOrdChange/TPCXbody/TPCXitem/dtScheme/taxCategory) 0-1 (XPath TEXPrintOrdChange/terms/allowanceCharge/dtScheme/taxCategory) 0-1</p>
taxRate	<p>duty or tax or fee percent rate - base type: string, (XPath TEXPrintOrdChange/terms/allowanceCharge/dtScheme/taxRate) 0-1 (XPath TEXPrintOrdChange/TPCXbody/TPCXitem/dtScheme/taxRate) 0-1</p>
@taxType	<p>duty or tax or fee type - base type: string, cod. table: T61 http://www.ebiz.enea.it/moda-ml/repository/codelist/v2018-1/gc_T61.xml (XPath TEXPrintOrdChange/TPCXbody/TPCXitem/dtScheme/@taxType) [Required] (XPath TEXPrintOrdChange/terms/allowanceCharge/dtScheme/@taxType) [Require d]</p>

@TID	serial number wired into the RFID chip - base type: string, (XPath TEXPrintOrdChange/TPCXbody/TPCXitem/fabricProd/piece/EPC/@TID) [Optional]
tolerance	deviation tolerated on the value of a measurement (it must have a plus or minus sign) - base type: decimal, (XPath TEXPrintOrdChange/TPCXbody/TPCXitem/fabricProd/fabricSpecs/tolerance) 0-2
totFault	total number of faults: the 1st/2nd digit count the "Large faults", the 3rd/4th the "Medium faults" and the 5th/6th the "Small faults" - base type: positiveInteger, (XPath TEXPrintOrdChange/TPCXbody/TPCXitem/fabricProd/piece/totFault) 0-1
transCondition	special condition of transport or special service requested to the Forwarder - base type: string, cod. table: T38 http://www.ebiz.enea.it/moda-ml/repository/codelist/v2018-1/gc_T38.xml (XPath TEXPrintOrdChange/terms/transInfo/transCondition) 0-3
transConditionText	free text description of the special condition of transport or special service requested to the Forwarder - base type: string, max length: 250, (XPath TEXPrintOrdChange/terms/transInfo/transConditionText) 0-1 (U)
transMeans	means of transport, in general or referred to a specific leg - base type: string, cod. table: T40 http://www.ebiz.enea.it/moda-ml/repository/codelist/v2018-1/gc_T40.xml (XPath TEXPrintOrdChange/terms/transInfo/transMeans) 0-1
transMode	way of transport, in general or referred to the specified leg - base type: string, cod. table: T8 http://www.ebiz.enea.it/moda-ml/repository/codelist/v2018-1/gc_T8.xml (XPath TEXPrintOrdChange/terms/transInfo/transMode) 1-1
@transReason	reason for the transport - base type: string, cod. table: NT11 http://www.ebiz.enea.it/moda-ml/repository/codelist/v2018-1/gc_NT11.xml (XPath TEXPrintOrdChange/terms/transInfo/@transReason) [Optional]
@uid	unique element identifier within the xml document - base type: string, (XPath TEXPrintOrdChange/TPCXbody/TPCXitem/fabricComponent/refDoc/attachment/@uid) [Optional] (XPath TEXPrintOrdChange/TPCXbody/TPCXitem/refDoc/attachment/@uid) [Optional] (XPath TEXPrintOrdChange/TPCXbody/TPCXitem/fabPrintOperation/refDoc/attachment/@uid) [Optional] (XPath TEXPrintOrdChange/TPCXheader/refDoc/attachment/@uid) [Optional]
@um	specification of the unit of measure - base type: string, cod. table: NT7 http://www.ebiz.enea.it/moda-ml/repository/codelist/v2018-1/gc_NT7.xml (XPath TEXPrintOrdChange/terms/allowanceCharge/@um) [Optional] (a) (XPath TEXPrintOrdChange/terms/transInfo/netWeight/@um) [Required] (XPath TEXPrintOrdChange/terms/transInfo/grossWeight/@um) [Required] (XPath TEXPrintOrdChange/TPCXbody/TPCXitem/fabricProd/piece/pieceWidth/@um) [Optional] [Default= CMT] (XPath TEXPrintOrdChange/TPCXbody/TPCXitem/fabricProd/piece/pieceCutWidth/@um) [Optional] [Default= CMT] (XPath TEXPrintOrdChange/TPCXbody/TPCXitem/fabricProd/piece/pieceWeight/@um) [Optional] [Default= KGM] (XPath TEXPrintOrdChange/TPCXbody/TPCXitem/fabricProd/pieceChain/pieceCut/pieceLength/@um) [Optional] [Default= MTR]

	<p>(XPath TEXPrintOrdChange/TPCXbody/TPCXitem/fabricProd/pieceChain/pieceCut/pieceWeight/@um) [Optional] [Default= KGM]</p> <p>(XPath TEXPrintOrdChange/TPCXbody/TPCXitem/fabricProd/piece/pieceLength/@um) [Optional] [Default= MTR]</p> <p>(XPath TEXPrintOrdChange/TPCXbody/TPCXitem/qty/@um) [Required]</p> <p>(XPath TEXPrintOrdChange/TPCXbody/TPCXitem/price/@um) [Optional]</p> <p>- nota: <i>Unit of measure of the product to which the price is referred (price per meter)</i></p> <p>(XPath TEXPrintOrdChange/TPCXbody/TPCXitem/fabricComponent/qty/@um) [Required]</p> <p>(XPath TEXPrintOrdChange/TPCXbody/TPCXitem/fabricProd/piece/pieceWeightM/@um) [Optional] [Default= GRM]</p> <p>(XPath TEXPrintOrdChange/TPCXbody/TPCXitem/fabricProd/piece/grossWeight/@um) [Required]</p> <p>(XPath TEXPrintOrdChange/TPCXbody/TPCXitem/fabricProd/piece/pieceAllow/@um) [Required]</p> <p>(XPath TEXPrintOrdChange/TPCXbody/TPCXitem/fabricProd/fabricSpecs/tolerance/@um) [Required]</p> <p>(XPath TEXPrintOrdChange/TPCXbody/TPCXitem/fabricProd/fabricSpecs/pcTolerance/@um) [Optional]</p> <p>- nota: <i>to be used when it has to be soecified if the declared percentage is b y weight, volume, etc...</i></p> <p>(XPath TEXPrintOrdChange/TPCXbody/TPCXitem/fabricProd/fabricWidth/@um) [Optional] [Default= CMT]</p> <p>(XPath TEXPrintOrdChange/TPCXbody/TPCXitem/fabricProd/fabricSpecs/specValue/@um) [Optional]</p> <p>(XPath TEXPrintOrdChange/TPCXbody/TPCXitem/fabPrintOperation/fabPrintSpecs/specValue/@um) [Optional]</p> <p>(XPath TEXPrintOrdChange/TPCXbody/TPCXitem/fabricProd/pieceChain/pieceLength/@um) [Optional] [Default= MTR]</p> <p>(XPath TEXPrintOrdChange/TPCXbody/TPCXitem/fabricProd/pieceChain/pieceWidth/@um) [Optional] [Default= CMT]</p> <p>(XPath TEXPrintOrdChange/TPCXbody/TPCXitem/fabricProd/pieceChain/pieceWeight/@um) [Optional] [Default= KGM]</p>
uri	<p>Uniform Resource Identifier (URI) that identifies the external object as an Internet resource</p> <p>- base type: normalizedString,</p> <p>(XPath TEXPrintOrdChange/TPCXbody/TPCXitem/refDoc/attachment/externalReference/uri) 1-1 (N)</p> <p>(XPath TEXPrintOrdChange/TPCXheader/refDoc/attachment/externalReference/uri) 1-1 (N)</p> <p>(XPath TEXPrintOrdChange/TPCXbody/TPCXitem/fabricComponent/refDoc/attachment/externalReference/uri) 1-1 (N)</p> <p>(XPath TEXPrintOrdChange/TPCXbody/TPCXitem/fabPrintOperation/refDoc/attachment/externalReference/uri) 1-1 (N)</p>
@useProfile	<p>use profile to which the present document if compliant if it was agreed by the parties. It is suggested a URI with reference to the firms or the URL of the profile.</p> <p>- base type: string,</p> <p>(XPath TEXPrintOrdChange/@useProfile) [Optional]</p>
@VAT	<p>VAT rate or code (DEPRECATED, use dtScheme element)</p> <p>- base type: string, cod. table: NT16</p> <p>http://www.ebiz.enea.it/moda-ml/repository/codelist/v2018-1/gc_NT16.xml</p> <p>(XPath TEXPrintOrdChange/TPCXbody/TPCXitem/thirdParty/@VAT) [Optional]</p> <p>(XPath TEXPrintOrdChange/TPCXheader/thirdParty/@VAT) [Optional]</p> <p>(XPath TEXPrintOrdChange/terms/allowanceCharge/@VAT) [Optional]</p> <p>(XPath TEXPrintOrdChange/TPCXbody/TPCXitem/lineN/@VAT) [Optional]</p> <p>- nota: <i>Deprecated, prefer dtScheme when available.</i></p>

<i>@version</i>	Dictionary version from which the instance has been created - base type: string, cod. table: NT100 http://www.ebiz.enea.it/moda-ml/repository/codelist/v2018-1/gc_NT100.xml (XPath <code>TEXPrintOrdChange/@version</code>) [Optional] [Default= 2018-1]
-----------------	---

2.3 Suggested best practices

TEXPrintOrdChange/TPCXbody/TPCXitem/fabPrintOperation/refDoc/docID (identification number of the referenced document SINCE 2008-1 ITS USE IN THE HEADER IS DISCOURAGED (REPLACED BY msgID))

numberingOrg indicates the role that produced the document identifier (it is allowed to declare two different ones -e.g. customer and supplier - with two docID with different numberingOrg

TEXPrintOrdChange/TPCXbody/TPCXitem/refDoc/docID (identification number of the referenced document SINCE 2008-1 ITS USE IN THE HEADER IS DISCOURAGED (REPLACED BY msgID))

numberingOrg indicates the role that produced the document identifier (it is allowed to declare two different ones -e.g. customer and supplier - with two docID with different numberingOrg

TEXPrintOrdChange/TPCXheader/refDoc/docID (identification number of the referenced document SINCE 2008-1 ITS USE IN THE HEADER IS DISCOURAGED (REPLACED BY msgID))

numberingOrg indicates the role that produced the document identifier (it is allowed to declare two different ones -e.g. customer and supplier - with two docID with different numberingOrg

TEXPrintOrdChange/TPCXbody/TPCXitem/fabricComponent/refDoc/docID (identification number of the referenced document SINCE 2008-1 ITS USE IN THE HEADER IS DISCOURAGED (REPLACED BY msgID))

numberingOrg indicates the role that produced the document identifier (it is allowed to declare two different ones -e.g. customer and supplier - with two docID with different numberingOrg

**TEXPrintOrdChange/TPCXheader/refDoc/attachment/
externalReference/mimeCode** (mime type of the external object)

Use coding from IANA <http://www.iana.org/assignments/media-types/media-types.xml>

**TEXPrintOrdChange/TPCXbody/TPCXitem/refDoc/
attachment/externalReference/mimeCode** (mime type of the external object)

Use coding from IANA <http://www.iana.org/assignments/media-types/media-types.xml>

TEXPrintOrdChange/TPCXbody/TPCXitem/fabricComponent/refDoc/attachment/externalReference/mimeCode (mime type of the external object)

Use coding from IANA <http://www.iana.org/assignments/media-types/media-types.xml>

TEXPrintOrdChange/TPCXbody/TPCXitem/fabPrintOperation/refDoc/attachment/externalReference/mimeCode (mime type of the external object)

Use coding from IANA <http://www.iana.org/assignments/media-types/media-types.xml>

TEXPrintOrdChange/TPCXbody/TPCXitem/fabricComponent/itemsList/itemIdentification/serialN (serial number used for the identification of a physical unit)

in the case of garment with RFID for anti-counterfeiting, RFID EPCGlobal for logistics and NFC for the customer experience there should be three serial elements with pairs of attributes numberingOrg/idQualifier: "CL"/"RFID", "GS1"/"RFID", "CL"/"NFC".

**TEXPrintOrdChange/TPCXbody/TPCXitem/fabricProd/
piece/serialN (serial number used for the identification of a physical unit)**

This element might contain also codes for RFID devices.

2.4 Enumeration tables

List of enumeration tables used in the XML document. You can find the corresponding codes at:
<http://www.ebiz-tcf.eu/moda-ml/imple/moda-ml-2018-1.asp?lingua=en&pag=6>

Legenda

- N: new table
- U: updated properties

NT100 - eBIZ TCFUpstream version
NT11 - transport causal
NT12 - data source
NT16 - VAT rate or code
NT18 - message function
NT2 - third party qualifier
NT20 - price qualifier
NT22 - product type of an operation
NT29 - format of a date
NT3 - data format
NT38 - colour test
NT4 - end use
NT5 - action code
NT6 - coding system owner/issuer
NT60 - language, codes from ISO 639-1 (subset) (N)
NT7 - unit of measure (U)
T1 - terms of payment
T10 - ISO3166 - Country
T13 - CFM properties of fabric
T16 - dyestuff type
T19 - fibre type
T2 - Modes of payment
T21 - type of document
T264 - fabric printing technology
T3 - terms of delivery
T38 - transport conditions
T4 - fabric piece inner packing (wrapping) 1
T40 - type of transport means
T41 - type of Allowance or Charge
T44 - additional code type
T45 - fabric print parameter type
T5 - fabric piece inner packing (wrapping) 2
T52 - fabric piece status
T6 - fabric piece outer packing
T61 - duty or tax or fee type
T62 - duty or tax or fee category
T8 - Modes of Transport
T9 - ISO4217 - Currency

Annex A

Representative images of the principal complex elements' structure.

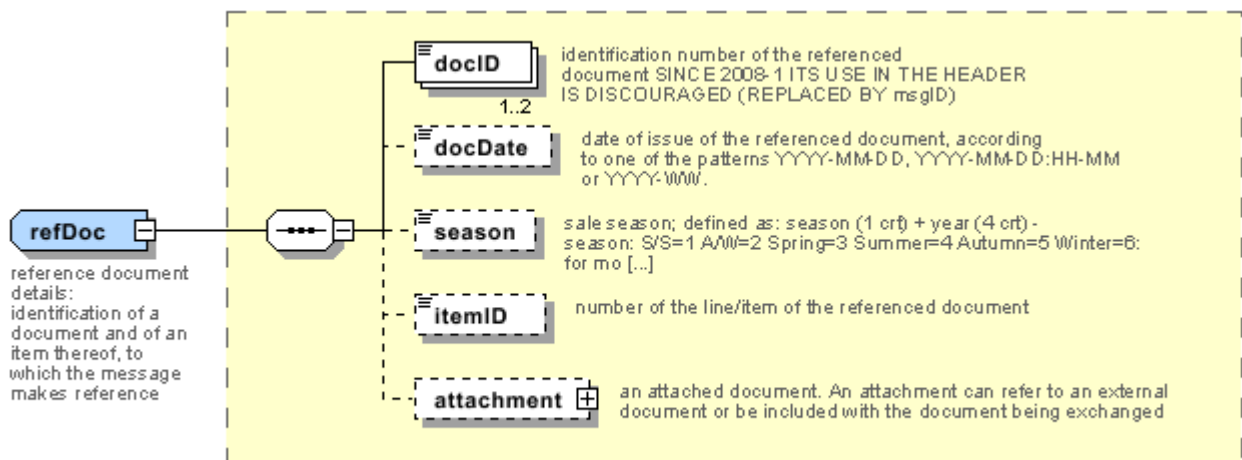
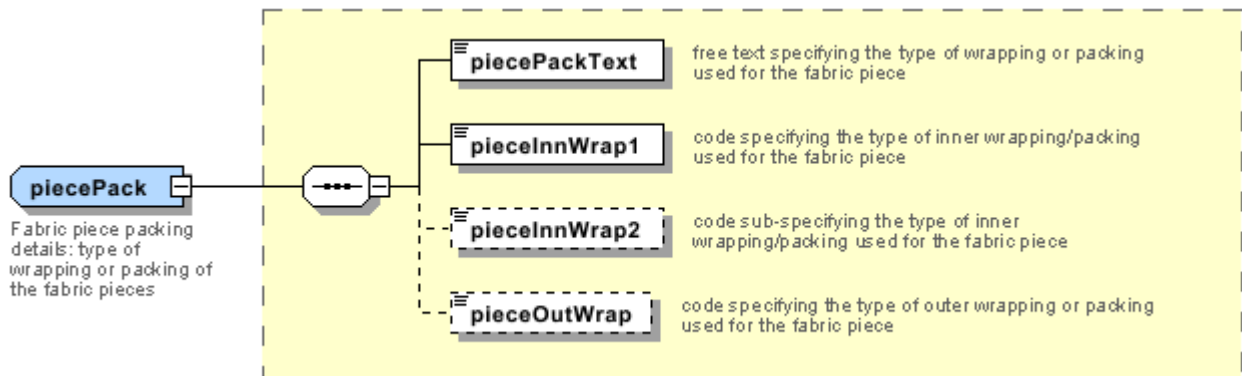
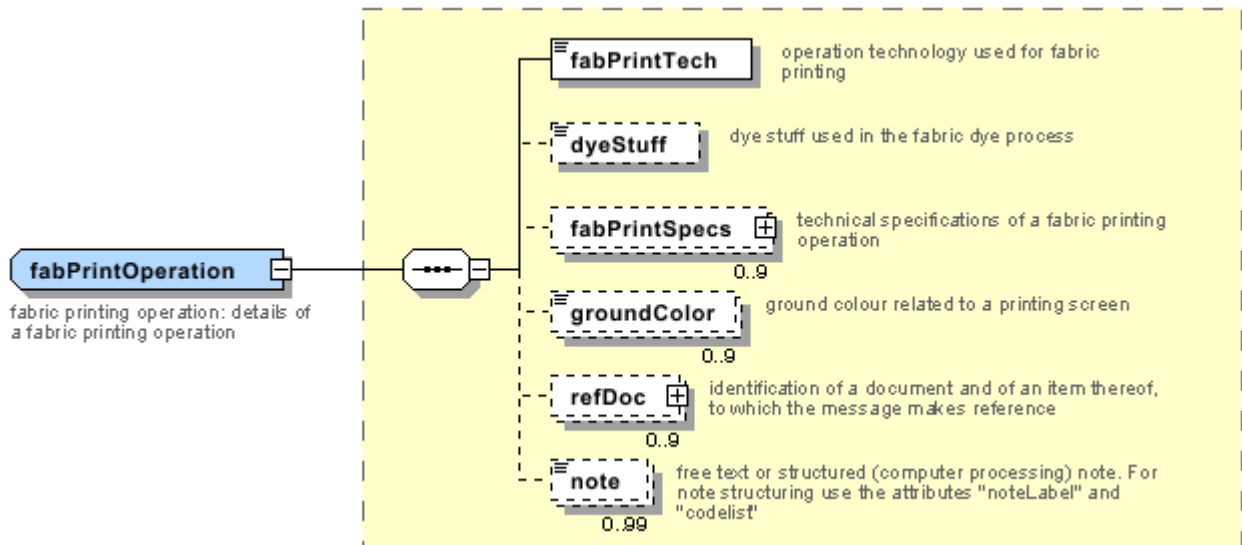

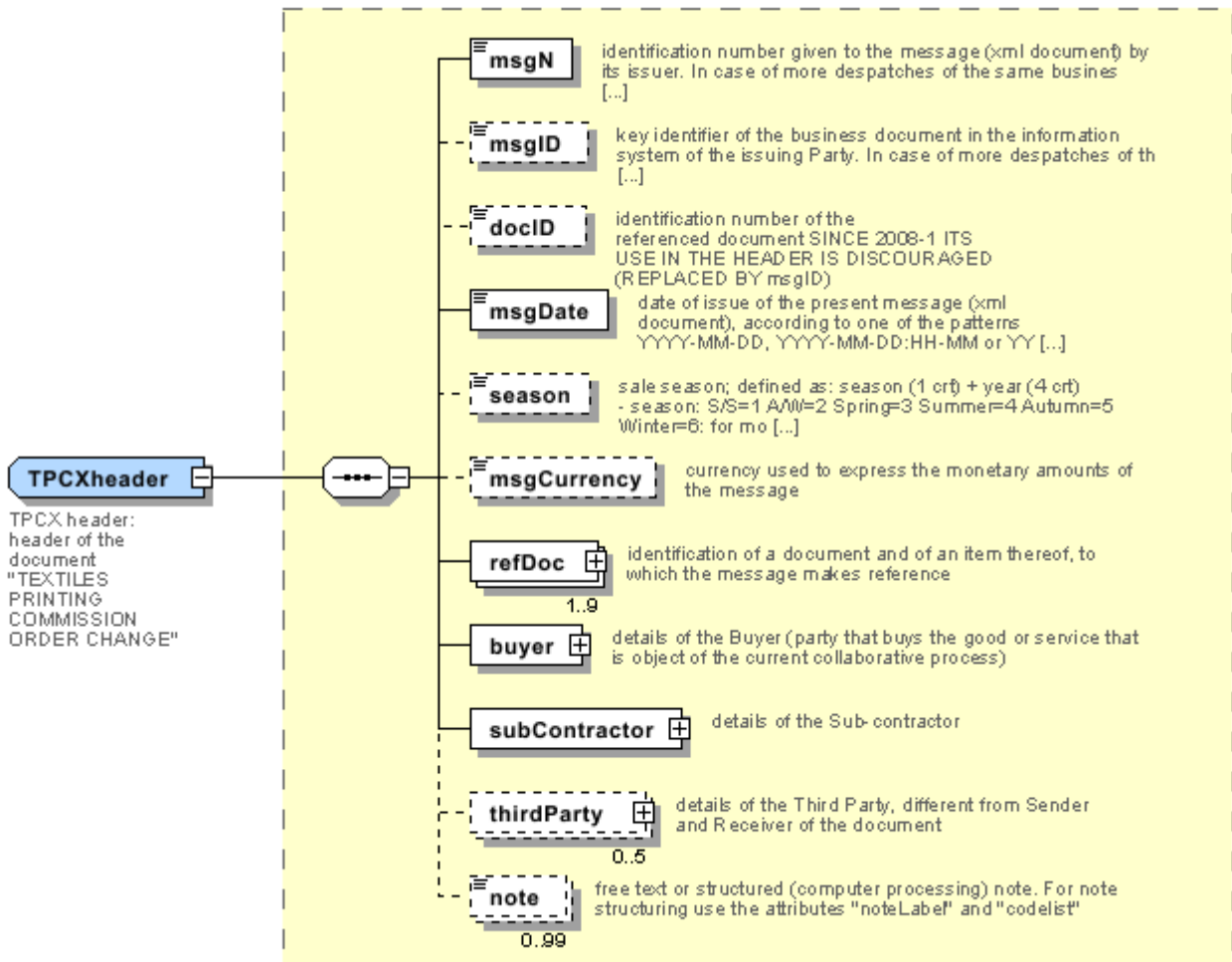
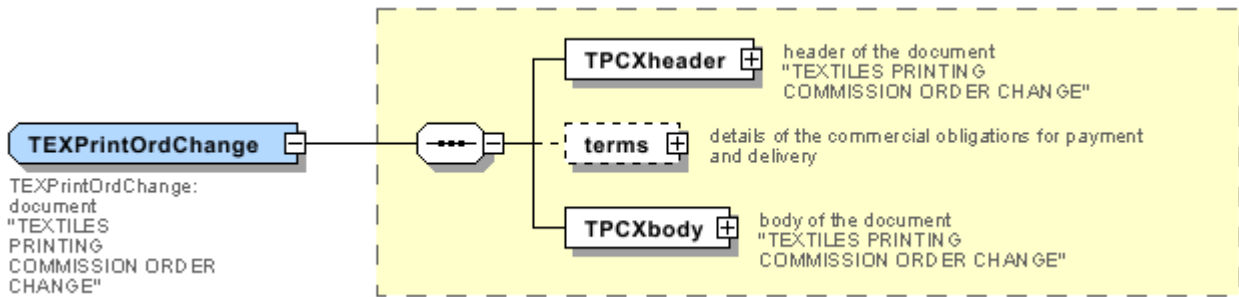

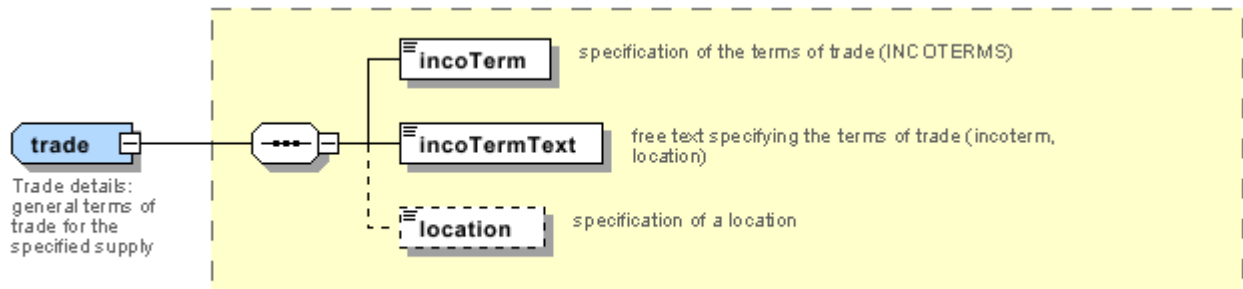
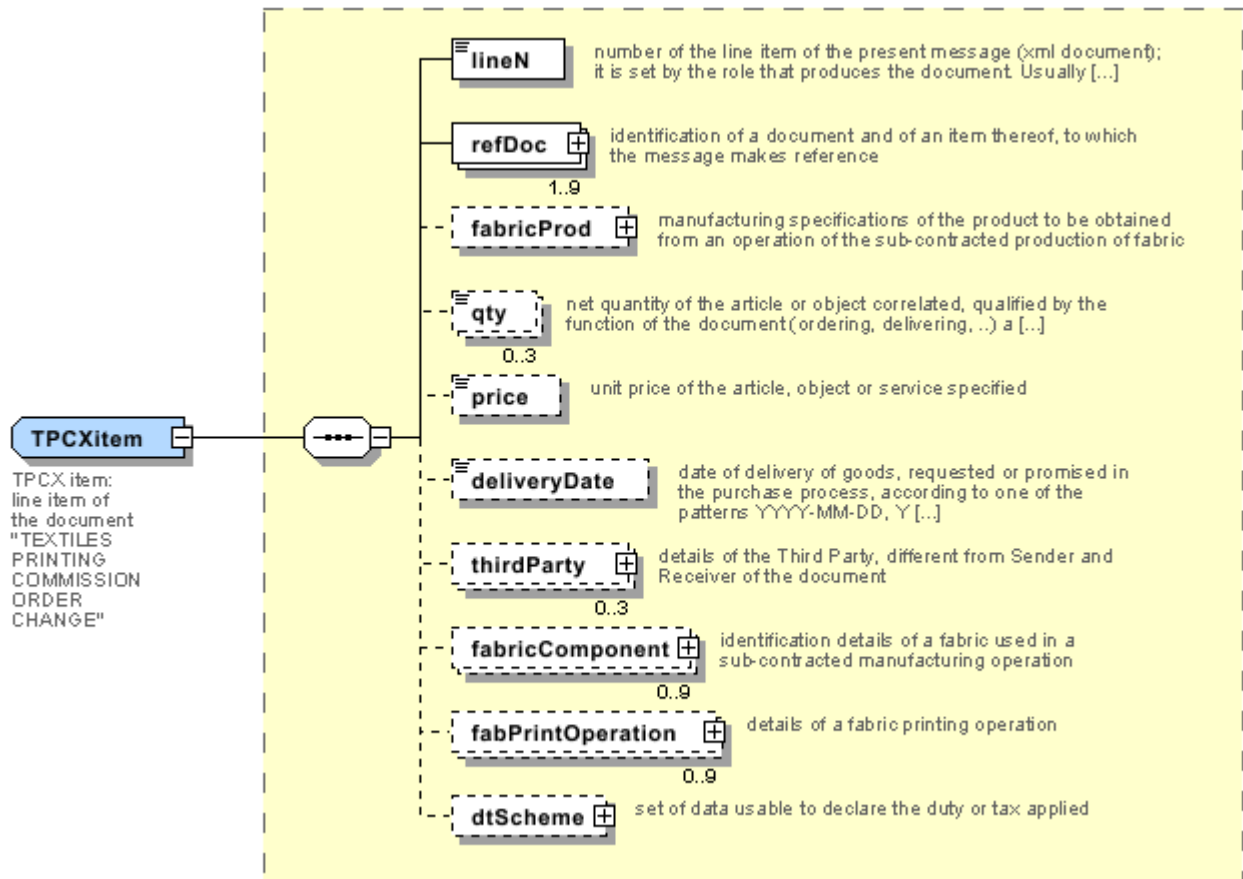

Annex B

NT100 - eBIZ TCFUpstream version

dictionary version

Agency name: eBIZ

tabella cod.: NT100

File codes list (Generic code): http://www.ebiz.enea.it/moda-ml/repository/codelist/v2018-1/gc_NT100.xml

Code	Description	Adoption note	Version status	Date of insertion
2013-1	v2013-1			01/07/2013
2018-1	v2018-1		(N)	04/11/2018
draft	draft		(N)	08/09/2017

NT11 - transport causal

reason for the transport

Agency name: eBIZ

tabella cod.: NT11

File codes list (Generic code): http://www.ebiz.enea.it/moda-ml/repository/codelist/v2018-1/gc_NT11.xml

Code	Description	Adoption note	Version status	Date of insertion
FOC	free of charge			
FRW	return from re-works			
FST	return from storage			
FWW	return from view			
FWK	return from works			
IST	in storage			
NWK	return non-worked			
RJC	return from rejection			
SEL	to sell			
STO	to storage			
VEW	to view			
WRK	to works			

NT12 - data source

party who has provided the data

Agency name: eBIZ

tabella cod.: NT12

File codes list (Generic code): http://www.ebiz.enea.it/moda-ml/repository/codelist/v2018-1/gc_NT12.xml

Code	Description	Adoption note	Version status	Date of insertion
AC	internal test			
CO	external test			
CV	test after steaming			

NT16 - VAT rate or code

VAT rate or code (DEPRECATED, use dtScheme element)

tabella cod.: NT16

File codes list (Generic code): http://www.ebiz.enea.it/moda-ml/repository/codelist/v2018-1/gc_NT16.xml

NT18 - message function

function performed by the present message with regards to the transmission

Agency name: eBIZ

tabella cod.: NT18

File codes list (Generic code): http://www.ebiz.enea.it/moda-ml/repository/codelist/v2018-1/gc_NT18.xml

Code	Description	Adoption note	Version status	Date of insertion
CA	delete this document			01/07/2013
CP	copy			
OR	original			
RC	re-transmission for data correction			
RT	re-transmission			

NT2 - third party qualifier

Third Party role qualifier

Agency name: eBIZ

tabella cod.: NT2

File codes list (Generic code): http://www.ebiz.enea.it/moda-ml/repository/codelist/v2018-1/gc_NT2.xml

Code	Description	Adoption note	Version status	Date of insertion
AG	Sales Agent			
AU	Auditor		(N)	08/04/2019
CE	Certification authority		(N)	08/04/2019
CO	Quality Controller			
DC	Response to			
DF	Invoicee			
DI	Copy to (CC)			28/10/2014
DM	Consignee			
DP	Consignment address (Delivery Party)			
IM	Importer			
OR	Originator			10/09/2014
SC	Sub contractor		(N)	10/04/2019
SM	Service/ePlatform manager		(N)	08/04/2019
SP	Forwarder			
TX	Tax Representative			

NT20 - price qualifier

type of price with reference to discount and taxes

Agency name: eBIZ

tabella cod.: NT20

File codes list (Generic code): http://www.ebiz.enea.it/moda-ml/repository/codelist/v2018-1/gc_NT20.xml

Code	Description	Adoption note	Version status	Date of insertion
GET	gross excluding taxes			
GIT	gross including taxes			
NET	net excluding taxes			
NIT	net including taxes			

NT22 - product type of an operation

level of the product (end or intermediate) yielded by an operation in a work cycle

Agency name: eBIZ

tabella cod.: NT22

File codes list (Generic code): http://www.ebiz.enea.it/moda-ml/repository/codelist/v2018-1/gc_NT22.xml

Code	Description	Adoption note	Version status	Date of insertion
END	end-product			
INT	intermediate			

NT29 - format of a date

format used for the date

Agency name: eBIZ

tabella cod.: NT29

File codes list (Generic code): http://www.ebiz.enea.it/moda-ml/repository/codelist/v2018-1/gc_NT29.xml

Code	Description	Adoption note	Version status	Date of insertion
D	YYYY-MM-DD			
M	YYYY-MM-DD:HH-MM			
W	YYYY-WW			

NT3 - data format

format of a string according to a customized User rule (local rule)

Agency name: eBIZ

tabella cod.: NT3

File codes list (Generic code): http://www.ebiz.enea.it/moda-ml/repository/codelist/v2018-1/gc_NT3.xml

Code	Description	Adoption note	Version status	Date of insertion
EN4	GS1-GLN			01/07/2013
MD	mutually agreed			

NT38 - colour test

specification of colour test before the operation

tabella cod.: NT38

File codes list (Generic code): http://www.ebiz.enea.it/moda-ml/repository/codelist/v2018-1/gc_NT38.xml

Code	Description	Adoption note	Version status	Date of insertion
1	only colour test			
2	with colour test			

NT4 - end use

specifies the final use of the product

Agency name: eBIZ

tabella cod.: NT4

File codes list (Generic code): http://www.ebiz.enea.it/moda-ml/repository/codelist/v2018-1/gc_NT4.xml

Code	Description	Adoption note	Version status	Date of insertion
PC	test piece			
PR	production			
SA	Sample		(N)	10/09/2014
SC	samples card			
TI	patch			
TP	(test cut)			

NT5 - action code

action performed by the present line upon the referenced document line

Agency name: eBIZ

tabella cod.: NT5

File codes list (Generic code): http://www.ebiz.enea.it/moda-ml/repository/codelist/v2018-1/gc_NT5.xml

Code	Description	Adoption note	Version status	Date of insertion
A	CANCELLED			
C	CONFIRMED			
N	NEW ORDER LINE (created by an order change)			
R	PROVISIONAL CONFIRMATION			
S	DEFINITIVE CONFIRMATION			
SA	suspension accepted			
SN	suspension not accepted			
SR	suspension request			

V	AMENDED			
---	---------	--	--	--

NT6 - coding system owner/issuer

code specifying the organisation who has created or owns the coding or numbering system

Agency name: eBIZ

tabella cod.: NT6

File codes list (Generic code): http://www.ebiz.enea.it/moda-ml/repository/codelist/v2018-1/gc_NT6.xml

Code	Description	Adoption note	Version status	Date of insertion
CL	Customer/buyer			
CO	Quality Controller			
EB	eBIZ	replaces 'ML'	(N)	18/03/2019
EN	GS1 (ex-EAN International)			
ES	e-Stockflow			
FO	Supplier			
GS	GS1			01/07/2013
MF	VAT identifier		(U)	
ML	Moda-ML	DEPRECATED	(U)	
SP	Service Provider			

NT60 - language, codes from ISO 639-1 (subset) (N)

Agency name: eBIZ / ISO

tabella cod.: NT60

File codes list (Generic code): http://www.ebiz.enea.it/moda-ml/repository/codelist/v2018-1/gc_NT60.xml

Code	Description	Adoption note	Version status	Date of insertion
af	Afrikaans		(N)	31/01/2019
ar	Arabic		(N)	31/01/2019
be	Belarusian		(N)	31/01/2019
bg	Bulgarian		(N)	31/01/2019
bn	Bengali		(N)	31/01/2019
bo	Tibetan		(N)	31/01/2019
bs	Bosnian		(N)	31/01/2019
ca	Catalan, Valencian		(N)	31/01/2019

cs	Czech		(N)	31/01/2019
da	Danish		(N)	31/01/2019
de	German		(N)	31/01/2019
el	Greek, Modern (1453-)		(N)	31/01/2019
en	English		(N)	31/01/2019
eo	Esperanto		(N)	31/01/2019
es	Spanish, Castilian		(N)	31/01/2019
et	Estonian		(N)	31/01/2019
eu	Basque		(N)	31/01/2019
F	Female		(N)	15/04/2019
fa	Persian		(N)	31/01/2019
fi	Finnish		(N)	31/01/2019
fr	French		(N)	31/01/2019
ga	Irish		(N)	31/01/2019
gd	Gaelic, Scottish Gaelic		(N)	31/01/2019
gn	Guarani		(N)	31/01/2019
he	Hebrew		(N)	31/01/2019
hr	Croatian		(N)	31/01/2019
ht	Haitian, Haitian Creole		(N)	31/01/2019
hu	Hungarian		(N)	31/01/2019
hy	Armenian		(N)	31/01/2019
ia	Interlingua (International Auxiliary Language Association)		(N)	31/01/2019
id	Indonesian		(N)	31/01/2019
is	Icelandic		(N)	31/01/2019
it	Italian		(N)	31/01/2019
ja	Japanese		(N)	31/01/2019
jv	Javanese		(N)	31/01/2019
ka	Georgian		(N)	31/01/2019
km	Central Khmer		(N)	31/01/2019
ko	Korean		(N)	31/01/2019
ku	Kurdish		(N)	31/01/2019
lb	Luxembourgish, Letzeburgesch		(N)	31/01/2019
lo	Lao		(N)	31/01/2019
lt	Lithuanian		(N)	31/01/2019
lv	Latvian		(N)	31/01/2019

mg	Malagasy		(N)	31/01/2019
mk	Macedonian		(N)	31/01/2019
mn	Mongolian		(N)	31/01/2019
mt	Maltese		(N)	31/01/2019
nl	Dutch, Flemish		(N)	31/01/2019
no	Norwegian		(N)	31/01/2019
pl	Polish		(N)	31/01/2019
pt	Portuguese		(N)	31/01/2019
ro	Romanian, Moldavian, Moldovan		(N)	31/01/2019
ru	Russian		(N)	31/01/2019
se	Northern Sami		(N)	31/01/2019
sk	Slovak		(N)	31/01/2019
sl	Slovenian		(N)	31/01/2019
sm	Samoan		(N)	31/01/2019
so	Somali		(N)	31/01/2019
sq	Albanian		(N)	31/01/2019
sr	Serbian		(N)	31/01/2019
sv	Swedish		(N)	31/01/2019
sw	Swahili		(N)	31/01/2019
ta	Tamil		(N)	31/01/2019
th	Thai		(N)	31/01/2019
tr	Turkish		(N)	31/01/2019
uk	Ukrainian		(N)	31/01/2019
ur	Urdu		(N)	31/01/2019
uz	Uzbek		(N)	31/01/2019
vi	Vietnamese		(N)	31/01/2019
zh	Chinese		(N)	31/01/2019

NT7 - unit of measure (U)

specification of the unit of measure, it is a sub set of table Unit of Measure Code - UN/ECE REC 20 delivered by United Nations Economic Commission for Europe (UN/ECE)

Agency name: eBIZ / UN/ECE

tabella cod.: NT7

File codes list (Generic code): http://www.ebiz.enea.it/moda-ml/repository/codelist/v2018-1/gc_NT7.xml

Other link: <http://docs.oasis-open.org/ubl/os-UBL-2.1/cl/gc/default/UnitOfMeasureCode-2.1.gc#>

Code	Description	Adoption note	Version status	Date of insertion
CMK	square centimetre		(N)	20/12/2017
CMQ	cubic centimetre		(N)	20/12/2017
CMT	centimetre			
CNE	centiNewton			
CO2TON	ton of CO2		(N)	10/09/2014
COUPLES	couples			
DMQ	cubic decimetre			
E37	pixel		(N)	11/04/2018
GRM	gram			
HUR	hour			
INH	inch			
KGM	kilogram			
KMT	kilometer			
KWH	kilowatthours		(N)	10/09/2014
LBR	pound			
MIN	minute			
MMK	square millimetre		(N)	20/12/2017
MTK	square metre		(N)	20/12/2017
MTQ	cubic metre			
MTR	metre			
NMB	numero			
ONZ	ounce			
P1	percent			
PPM	parts per milion			
PZ	piece		(U)	
RPM	rounds per metre			
YRD	yard			

T1 - terms of payment

code specifying the terms or time by which the payment must be done

Agency name: eBIZ

tabella cod.: T1

File codes list (Generic code): http://www.ebiz.enea.it/moda-ml/repository/codelist/v2018-1/gc_T1.xml

Code	Description	Adoption note	Version status	Date of insertion
ANTICIP	PAYMENT IN ADVANCE			
BLCOLLECT/120D	BILL OF LADING 120 DD			
BLCOLLECT/30D	BILL OF LADING 30 DD			
BLCOLLECT/60D	BILL OF LADING 60 DD			
BLCOLLECT/90D	BILL OF LADING 90 DD			
CASH	PAYMENT ON DELIVERY			
CASHINV	PAYMENT ON RECEIPT OF INVOICE			
CREDOC/0D	DOCUMENTARY CREDIT FOR PAYM. AT SIGHT			
CREDOC/120	DOCUMENTARY CREDIT FOR PAYM. AT 120 DD			
CREDOC/150	DOCUMENTARY CREDIT FOR PAYM. AT 150 DD			
CREDOC/180	DOCUMENTARY CREDIT FOR PAYM. AT 180 DD			
CREDOC/30D	DOCUMENTARY CREDIT FOR PAYM. AT 30 DD			
CREDOC/45D	DOCUMENTARY CREDIT FOR PAYM. AT 45 DD			
CREDOC/60	DOCUMENTARY CREDIT FOR PAYM. AT 60 DD			
CREDOC/90	DOCUMENTARY CREDIT FOR PAYM. AT 90 DD			
DEL/10	PAYMENT AT 10 DD AFTER DELIVERY			
DOCOLLECT/120D	DOCUMENTARY COLLECTION AT 120 DD			
DOCOLLECT/30D	DOCUMENTARY COLLECTION AT 30 DD			
DOCOLLECT/60D	DOCUMENTARY COLLECTION AT 60 DD			
DOCOLLECT/90D	DOCUMENTARY COLLECTION AT 90 DD			
INV/120D	PAYMENT AT 120 DD AFTER RECEIPT OF INVOICE			
INV/150D	PAYMENT AT 150 DD AFTER RECEIPT OF INVOICE			
INV/180D	PAYMENT AT 180 DD AFTER RECEIPT OF INVOICE			
INV/30D	PAYMENT AT 30 DD AFTER RECEIPT OF INVOICE			
INV/45D	PAYMENT AT 45 DD AFTER RECEIPT OF INVOICE			
INV/60D	PAYMENT AT 60 DD AFTER RECEIPT OF INVOICE			
INV/90D	PAYMENT AT 90 DD AFTER RECEIPT OF INVOICE			
INVULTIMO	PAYMENT AT END MONTH RECEIPT INVOICE			
INVULTIMO/10D	PAYMENT 10 DD AFTER END MONTH RECEIPT INVOICE			

INVULTIMO/120D	PAYMENT 120 DD AFTER END MONTH RECEIPT INV OICE			
INVULTIMO/150D	PAYMENT 150 DD AFTER END MONTH RECEIPT INV OICE			
INVULTIMO/180D	PAYMENT 180 DD AFTER END MONTH RECEIPT INV OICE			
INVULTIMO/240D	PAYMENT 240 DD AFTER END MONTH RECEIPT INV OICE			
INVULTIMO/30D	PAYMENT 30 DD AFTER END MONTH RECEIPT INVOI CE			
INVULTIMO/45D	PAYMENT 45 DD AFTER END MONTH RECEIPT INVOI CE			
INVULTIMO/60D	PAYMENT 60 DD AFTER END MONTH RECEIPT INVOI CE			
INVULTIMO/90D	PAYMENT 90 DD AFTER END MONTH RECEIPT INVOI CE			
NOPAY	WITHOUT PAYMENT			
RECREDOC/0D	IRREVOC. DOCUMENTARY CREDIT FOR PAYM. AT SI GHT			
RECREDOC/120 D	IRREVOC. DOCUMENTARY CREDIT FOR PAYM. AT 12 0 DD			
RECREDOC/150 D	IRREVOC. DOCUMENTARY CREDIT FOR PAYM. AT 15 0 DD			
RECREDOC/180 D	IRREVOC. DOCUMENTARY CREDIT FOR PAYM. AT 18 0 DD			
RECREDOC/30D	IRREVOC. DOCUMENTARY CREDIT FOR PAYM. AT 30 DD			
RECREDOC/45D	IRREVOC. DOCUMENTARY CREDIT FOR PAYM. AT 45 DD			
RECREDOC/60D	IRREVOC. DOCUMENTARY CREDIT FOR PAYM. AT 60 DD			
RECREDOC/90D	IRREVOC. DOCUMENTARY CREDIT FOR PAYM. AT 90 DD			
ULTIMO	PAYMENT BY END MONTH OF DELIVERY			
ULTIMO/10	PAYMENT AT 10 DD AFTER END MONTH OF DELIVER Y			

T10 - ISO3166 - Country

code of the nation

Agency name: ISO

tabella cod.: T10

File codes list (Generic code): http://www.ebiz.enea.it/moda-ml/repository/codelist/v2018-1/gc_T10.xml

Table not printed: there are 239 elements, more than the maximum specified for printing: 99.

T13 - CFM properties of fabric

code of the physical or mechanical parameter used to define a "technical characteristic of the fabric" (see Fabric technical sheet)

tabella cod.: T13

File codes list (Generic code): http://www.ebiz.enea.it/moda-ml/repository/codelist/v2018-1/gc_T13.xml

Code	Description	Adoption note	Version status	Date of insertion
CMA	resistance to pilling (UNI.E.1512434)			
CMB	seam slippage - warp (NFG7117)			
CMC	seam slippage - weft (NFG7117)			
CMD	breaking strength - warp (ISO 1394-1)			
CME	breaking strength - weft (ISO 1394-1)			
CMF	resistance to abrasion (EN 12947)			
CMH	tear strength (ISO 9290)			
CMI	crease recovery (ISO 9867)			
CMJ	elongation - warp (BS 4294/68)			
CMK	elongation - weft (BS 4294/68)			
CML	tear resistance - warp			
CMM	tear resistance - weft			
CMN	resistance to bending			
CMP	spray test			
SLA	colour fastness to light (ISO 105-B02)			
SLB	colour fastness to washing (ISO 105-C06)			
SLC	colour fastness to dry cleaning (ISO 105-D01)			
SLD	colour fastness to spotting water (ISO 105-E07)			
SLG	colour fastness to alkaline perspiration (ISO 105-E04)			
SLH	colour fastness to acid perspiration (ISO 105-E04)			
SLI	colour fastness to dry rubbing (ISO 105-X12)			
SLJ	colour fastness to wet rubbing (ISO 105-X12)			
SLK	colour fastness to dry ironing (ISO 105-X11)			
SLM	colour fastness to wet ironing (ISO 105-X11)			

SLW	colour fastness to water (ISO 105-E01)			
SLX	colour fastness to Xeno-light			
SLZ	colour fastness to rubbing org. Solv. (ISO 105-D02)			
STA	dimensional stability to steaming press - length (DIN 53894-2)			
STB	dimensional stability to steaming press - width (DIN 53894-2)			
STC	dimensional stability to washing - length (ISO 5077+6330)			
STD	dimensional stability to washing - width (ISO 5077+6330)			
STE	dimensional stability to dry cleaning - length (ISO 3175)			
STF	dimensional stability to dry cleaning - width (ISO 3175)			

T16 - dyestuff type

dye stuff used in the fabric dye process

Agency name: eBIZ

tabella cod.: T16

File codes list (Generic code): http://www.ebiz.enea.it/moda-ml/repository/codelist/v2018-1/gc_T16.xml

Code	Description	Adoption note	Version status	Date of insertion
AC	chrome acid dyestuff			
AN	acid dyestuff			
CA	basic dyestuff			
DI	direct dyestuff			
DS	disperse dyestuff			
NP	naphtol dyestuff			
PI	pigment			01/07/2013
PM	premetallized dyestuff			
RE	reactive dyestuff			
SU	sulfur			01/07/2013

T19 - fibre type

type of fibre used in a textile product

Agency name: eBIZ

tabella cod.: T19

File codes list (Generic code): http://www.ebiz.enea.it/moda-ml/repository/codelist/v2018-1/gc_T19.xml

Code	Description	Adoption note	Version status	Date of insertion
AB	abaca			20/08/2018
AC	acetate			
AF	other fibres			
AG	alginic fibre			
AL	alfa			20/08/2018
CA	hemp			
CC	coir (coconut)			20/08/2018
CL	chlorofibre			
CO	cotton			
CU	cuprous			
EA	elastan			
EL	Elastodiene			20/08/2018
FL	fluorofibre			
GI	broom			20/08/2018
GL	textile glass			
HA	hair			20/08/2018
HE	henequen			20/08/2018
HL	mixed linen			
HL	cotton linen union			20/08/2018
JU	jute			
KE	kenaf			20/08/2018
KP	kapoc			20/08/2018
LI	linen			
LY	lyocell			20/08/2018
MA	modacrylic			
MD	modal			
ME	metallized			
MG	maguey			20/08/2018
PA	polyamide			
PB	polyureic			
PC	acrylic			
PE	polyethylene			
PI	paper			20/08/2018
PL	polyester			

PM	polyimide			
PP	polypropylene			
PR	proteic			
PU	polyurethane			
RA	mamie			20/08/2018
SE	silk			
SI	sisal			20/08/2018
SN	sun			20/08/2018
TA	triacetate			
TR	textile residues or unspecified composition			20/08/2018
TV	trivinyll			
VI	viscose			
VY	vinylal			
WA	angora			
WB	beaver			20/08/2018
WC	cashgora			
WG	vicuna			
WK	camel			
WL	llama			
WM	mohair			
WN	lapin			20/08/2018
WO	wool			
WP	alpaca			
WS	cashmere			
WT	Oteer			20/08/2018
WU	guanaco			
WV	virgin wool			
WY	yack			

T2 - Modes of payment

way or means of payment

Agency name: eBIZ

tabella cod.: T2

File codes list (Generic code): http://www.ebiz.enea.it/moda-ml/repository/codelist/v2018-1/gc_T2.xml

Code	Description	Adoption note	Version status	Date of insertion
BB	bank transfer			
IA	collection through Agent			
IS	collection through Forwarder			
RB	bank receipt			
RD	remittance			
SW	bank SWIFT			
TR	bank draft			

T21 - type of document

type or class to which the referenced document belongs

Agency name: eBIZ

tabella cod.: T21

File codes list (Generic code): http://www.ebiz.enea.it/moda-ml/repository/codelist/v2018-1/gc_T21.xml

Code	Description	Adoption note	Version status	Date of insertion
BOR	blanket order		(N)	01/02/2018
CAT	Price catalogue - tech sheet			
CEO	Certificate of origin		(N)	13/04/2018
CER	Certificate		(N)	13/04/2018
COC	colour card			
CRN	Credit note			08/09/2017
CTO	Checking order			01/07/2013
CTR	Contract		(U)	
CXF	CxF3 file			01/07/2013
DAD	Darn order			
DDT	ddt			
DEA	Despatch advise			
DER	Despatch request			
DR	Document Request			02/12/2014
FOR	Forecast			02/12/2014
GSO	Garment stock offer			
GSX	Garment stock offer change			
INV	Invoice			

KCC	Knitting-Clothing Commission Order			02/12/2014
KCI	Garment in Work Inventory Report			02/12/2014
M2M	Made to Measure Production Order			02/12/2014
MAS	Master marker			
MCI	Visual merchandising instruction		(N)	13/04/2018
OCH	Order change			
OFF	Offer			
ORD	Purchase order			
ORP	Order response			
OSR	order status request			
OSS	Offer status			02/12/2014
OST	Order status			
OUR	our reference			
QR	Quality Report			02/12/2014
RAI	Raw Material in Work Inventory Report			02/12/2014
RDC	Raw dyeing commission order			
RDH	Raw dyeing order change			
RDR	Raw dyeing order response			
REA	Receiving advise			
REQ	Request for Offer			
RET	Return			02/12/2014
RSC	Spinning commission order			
RSH	Spinning order change			
RSR	Spinning order response			
SCL	process sheet			
TFC	Textile dyeing-finishing commission order			
TFX	Textile Dyeing-Finishing Order Change			02/12/2014
TPC	Textile printing commission order			
TPX	Textile Printing Order Change			02/12/2014
TWI	Textile in work inventory			
VMI	visual merchandising instructions		(N)	01/02/2018
WAC	Warping commission order			
WEC	Weaving commission order			
YDC	Yarn dyeing commission order			
YDH	Yarn dyeing order change			

YDR	Yarn dyeing order response			
YTC	Twisting commission order			
YWI	Yarn in work inventory			

T264 - fabric printing technology

operation technology used for fabric printing

Agency name: eBIZ

tabella cod.: T264

File codes list (Generic code): http://www.ebiz.enea.it/moda-ml/repository/codelist/v2018-1/gc_T264.xml

Code	Description	Adoption note	Version status	Date of insertion
BL	block printing			
DE	devoré printing			
DI	discharge printing			
FC	flock printing			
FL	flat printing			
HA	hand printing			
IJ	inkjet printing			01/07/2013
RE	resist printing			
RO	roller printing			
RS	rotary screen printing			
SC	screen printing			
TR	transfer printing			

T3 - terms of delivery

specification of the terms of trade (INCOTERMS)

Agency name: Incoterms

tabella cod.: T3

File codes list (Generic code): http://www.ebiz.enea.it/moda-ml/repository/codelist/v2018-1/gc_T3.xml

Code	Description	Adoption note	Version status	Date of insertion
CFR	COST AND FREIGHT (named port of destination)			

CIF	COST, INSURANCE AND FREIGHT (named port of destination)			
CIP	CARRIAGE AND INSURANCE PAID (named place of destination)			
CP T	CARRIAGE PAID (named place of destination)			
DA F	DELIVERED AT FRONTIER (named place)	according to Incoterms® 2010 it is obsolete		08/12/2017
DA P	Delivered at Place of destination (named place of destination)	according to Incoterms® 2010		08/12/2017
DA T	Delivered at Terminal (named place of destination)	according to Incoterms® 2010		08/12/2017
DD P	DELIVERED DUTY PAID (named place of destination)			
DD U	DELIVERED DUTY UNPAID (named place of destination)	according to Incoterms® 2010 it is obsolete, use DAP		08/12/2017
DE Q	DELIVERED EX-QUAY (named port of destination)	according to Incoterms® 2010 it is obsolete		08/12/2017
DE S	DELIVERED EX-SHIP (named port of destination)	according to Incoterms® 2010 it is obsolete		08/12/2017
EX W	EX WORKS (named place)			
FA S	FREE ALONGSIDE SHIP (named port of shipment)			
FC A	FREE CARRIER (named place)			
FO B	FREE ON BOARD (named port of shipment)			

T38 - transport conditions

special condition of transport or special service requested to the Forwarder

tabella cod.: T38

File codes list (Generic code): http://www.ebiz.enea.it/moda-ml/repository/codelist/v2018-1/gc_T38.xml

Code	Description	Adoption note	Version status	Date of insertion
ACC	arrange customs clearance			
CAL	Carrier loads			
CAU	Carrier unloads			
CMR	CMR carnet			
FFN	freight forwarders national conditions			
FLD	special agreement for full loading			

NCC	do not arrange customs clearance			
PPB	packaging paid by Buyer			
PPS	packaging paid by Supplier			
PRO	proof of delivery			
RFR	return container free			
RPC	return container paid by Customer			
RPS	return container paid by Supplier			
SHL	Shipper loads			
SHU	Consignee unloads			

T4 - fabric piece inner packing (wrapping) 1

code specifying the type of inner wrapping/packing used for the fabric piece

Agency name: eBIZ

tabella cod.: T4

File codes list (Generic code): http://www.ebiz.enea.it/moda-ml/repository/codelist/v2018-1/gc_T4.xml

Code	Description	Adoption note	Version status	Date of insertion
A	Folded, whole width			
B	Folded, doubled			
C	Folded, tube products			
D	Spooled, whole width			
E	Spooled, doubled, pli: left			
F	Spooled, doubled, pli: right			
G	Rolled, whole width, single item			
H	Rolled, whole width, several items			
I	Rolled, doubled			
J	Rolled, tube products			

T40 - type of transport means

means of transport, in general or referred to a specific leg

Agency name: eBIZ

tabella cod.: T40

File codes list (Generic code): http://www.ebiz.enea.it/moda-ml/repository/codelist/v2018-1/gc_T40.xml

Code	Description	Adoption note	Version status	Date of insertion
AIR	aircraft			
SHP	ship			
TRU	truck			
VAN	van			

T41 - type of Allowance or Charge

coded specification of an Allowance or Charge (elaborated from UNECE 4465)

Agency name: eBIZ

tabella cod.: T41

File codes list (Generic code): http://www.ebiz.enea.it/moda-ml/repository/codelist/v2018-1/gc_T41.xml

Code	Description	Adoption note	Version status	Date of insertion
1	Agreed settlement		(N)	19/08/2018
10	Costs for draft		(N)	19/08/2018
11	Bank charges	DEPRECATED, use CBK	(N)	19/08/2018
12	Agent commission		(N)	19/08/2018
14	Wrong delivery		(N)	19/08/2018
15	Goods returned to agent		(N)	19/08/2018
16	Goods partly returned		(N)	19/08/2018
17	Transport damage		(N)	19/08/2018
19	Trade discount		(N)	19/08/2018
2	Below specification goods		(N)	19/08/2018
20	Deduction for late delivery	DEPRECATED, use CWB	(N)	19/08/2018
21	Advertising costs		(N)	19/08/2018
22	Customs duties		(N)	19/08/2018

23	Telephone and postal costs		(N)	19/08/2018
24	Repair costs		(N)	19/08/2018
25	Attorney fees		(N)	19/08/2018
26	Taxes		(N)	19/08/2018
3	Damaged goods		(N)	19/08/2018
30	Direct payment to seller		(N)	19/08/2018
32	Goods not delivered		(N)	19/08/2018
33	Late delivery		(N)	19/08/2018
35	Goods returned		(N)	19/08/2018
36	Invoice not received		(N)	19/08/2018
37	Credit note to debtor/not to us		(N)	19/08/2018
38	Deducted bonus		(N)	19/08/2018
39	Deducted discount		(N)	19/08/2018
4	Short delivery		(N)	19/08/2018
40	Deducted freight costs		(N)	19/08/2018
41	Deduction against other invoices		(N)	19/08/2018
42	Credit balance(s)		(N)	19/08/2018
45	Debit note to seller		(N)	19/08/2018
46	Discount beyond terms		(N)	19/08/2018
48	Allowance/charge error		(N)	19/08/2018
49	Substitute product		(N)	19/08/2018
50	Terms of sale error		(N)	19/08/2018

52	Wrong invoice		(N)	19/08/2018
53	Duplicate invoice		(N)	19/08/2018
54	Weight error		(N)	19/08/2018
55	Additional charge not authorized		(N)	19/08/2018
56	Incorrect discount		(N)	19/08/2018
57	Price change		(N)	19/08/2018
58	Variation		(N)	19/08/2018
59	Chargeback		(N)	19/08/2018
65	Settlement to agent		(N)	19/08/2018
66	Cash discount		(N)	19/08/2018
7	Payment on account		(N)	19/08/2018
70	Wrong monetary amount resulting from incorrect free goods quantity		(N)	19/08/2018
72	Temporary special promotion		(N)	19/08/2018
73	Difference in tax rate		(N)	19/08/2018
74	Quantity discount		(N)	19/08/2018
75	Promotion discount		(N)	19/08/2018
76	Cancellation deadline passed		(N)	19/08/2018
77	Pricing discount		(N)	19/08/2018
78	Volume discount		(N)	19/08/2018
79	Sundry discount		(N)	19/08/2018
8	Returnable container charge included		(N)	19/08/2018
9	Invoice error		(N)	19/08/2018

AW A	bonus for works ahead of schedule			
CBK	bank charges			
CC R	servizio di corriere			
CIN	insurance			
CLB	labelling			
CPK	packing			
CSP	special packing			
CW B	penalty for works behind schedule			

T44 - additional code type

qualifier of the additional coding of a product

Agency name: eBIZ

tabella cod.: T44

File codes list (Generic code): http://www.ebiz.enea.it/moda-ml/repository/codelist/v2018-1/gc_T44.xml

Code	Description	Adoption note	Version status	Date of insertion
CC	colour card			
CL	sales collection			
CO	company identification code		(N)	08/09/2017
DY	dye number			
LT	lot number			
MDI	Made in			08/09/2017
MS	manufacturing state			
PKG	packaging			09/09/2014
PL	product line			
RGB	RGB value			
SE	selvedge code			

T45 - fabric print parameter type

code specifying a characteristic or parameter of the fabric printing

Agency name: eBIZ

tabella cod.: T45

File codes list (Generic code): http://www.ebiz.enea.it/moda-ml/repository/codelist/v2018-1/gc_T45.xml

Code	Description	Adoption note	Version status	Date of insertion
NC	number of colours			
RL	repeat length			
RW	repeat width			

T5 - fabric piece inner packing (wrapping) 2

code specifying the sub-type of inner wrapping/packing used for the fabric piece

Agency name: eBIZ

tabella cod.: T5

File codes list (Generic code): http://www.ebiz.enea.it/moda-ml/repository/codelist/v2018-1/gc_T5.xml

Code	Description	Adoption note	Version status	Date of insertion
A	Open			
B	Folded once, not looped			
C	Folded twice, not looped			
H	Folded once, looped			
I	Folded twice, looped			
J	Without inner object, right side inside			
K	On carton or spooling plank, right side inside			
L	On spool (for pressure sensitive products), right side inside			
M	Without inner object, left side inside			
N	On carton or spooling plank, left side inside			
O	On spool (for pressure sensitive products), left side inside			
P	Without inner object, right side inside (deprecated code)			
Q	On carton, right side inside			
R	On wooden stick, right side inside			
S	Without inner object, left side inside (deprecated code)			
T	On carton, left side inside			
U	On wooden stick, left side inside			

T52 - fabric piece status

code used to describe the status of a fabric piece with reference to the control

Agency name: eBIZ

tabella cod.: T52

File codes list (Generic code): http://www.ebiz.enea.it/moda-ml/repository/codelist/v2018-1/gc_T52.xml

Code	Description	Adoption note	Version status	Date of insertion
0	first registration			
C	registration from return			
F	stopped			
H	handling			
R	returned			
S	held			
T	deliverable			

T6 - fabric piece outer packing

code specifying the type of outer wrapping or packing used for the fabric piece

Agency name: eBIZ

tabella cod.: T6

File codes list (Generic code): http://www.ebiz.enea.it/moda-ml/repository/codelist/v2018-1/gc_T6.xml

Code	Description	Adoption note	Version status	Date of insertion
0	Not wrapped			
1	Totally wrapped			
2	Wrapped, one side open			
3	Wrapped, both sides open			
4	Wrapped, one side open, with show corner			
5	Wrapped in cartons			
6	Double wrapped			

T61 - duty or tax or fee type

duty or tax or fee type

Agency name: eBIZ

tabella cod.: T61

File codes list (Generic code): http://www.ebiz.enea.it/moda-ml/repository/codelist/v2018-1/gc_T61.xml

Code	Description	Adoption note	Version status	Date of insertion
BOL	stamp duty			01/07/2013
CUD	customs duty			01/07/2013
ENV	environmental tax			01/07/2013
FRE	no tax			01/07/2013
OTH	other tax charges			01/07/2013
VAT	value added tax			01/07/2013

T62 - duty or tax or fee category

duty or tax or fee category

Agency name: eBIZ

tabella cod.: T62

File codes list (Generic code): http://www.ebiz.enea.it/moda-ml/repository/codelist/v2018-1/gc_T62.xml

Code	Description	Adoption note	Version status	Date of insertion
AA	lower than standard rate			01/07/2013
E	tax not applicable			01/07/2013
H	higher than standard rate			01/07/2013
O	outside scope of tax			01/07/2013
S	standard rate			01/07/2013
Z	zero rate goods			01/07/2013

T8 - Modes of Transport

way of transport, in general or referred to the specified leg

Agency name: eBIZ

tabella cod.: T8

File codes list (Generic code): http://www.ebiz.enea.it/moda-ml/repository/codelist/v2018-1/gc_T8.xml

Code	Description	Adoption note	Version status	Date of insertion
1	MARITIME TRANSPORT			
10	Courier			01/07/2013

2	RAIL TRANSPORT			
3	ROAD TRANSPORT			
4	AIR TRANSPORT			
5	MAIL			
6	AIR + SHIP TRANSPORT			
8	INLAND WATER TRANSPORT			
9	MODE UNKNOWN			

T9 - ISO4217 - Currency

currency code

Agency name: ISO

tabella cod.: T9

File codes list (Generic code): http://www.ebiz.enea.it/moda-ml/repository/codelist/v2018-1/gc_T9.xml

Table not printed: there are 205 elements, more than the maximum specified for printing: 99.

Annex C

New or changed elements towards previous version

Changes or added elements (changes in description excluded; changes in aggregation notes and best practice included): 134

Test Type	Tag	Status	Item type	Changes related to
Attribute	AC_amount	NEW	AC amount	Has NEW attribute: data currency
Element(E)	AC_categoryText	UPDATED	AC category text	Property: Length_Max Old value: 70 New value: 250
Attribute	additionalIdentifier	NEW	Additional Party Identifier	Has NEW attribute: numbering organisation code
Attribute	additionalIdentifier	NEW	Additional Party Identifier	Has NEW attribute: id Qualifier
Element(I)	additionalIdentifier	NEW	Additional Party Identifier	
Attribute	allowanceCharge	NEW	Allowance and Charge	Has NEW attribute: is Charge
Attribute	allowanceCharge	NEW	Allowance and Charge	Has NEW attribute: maximum quantity
Attribute	allowanceCharge	NEW	Allowance and Charge	Has NEW attribute: minimum quantity
Attribute	allowanceCharge	NEW	Allowance and Charge	Has NEW attribute: data currency
Attribute	allowanceCharge	NEW	Allowance and Charge	Has NEW attribute: unit of measure code
Element(E)	art	UPDATED	article identifier	Property: Length_Max Old value: 25 New value: 80
Attribute	art	UPDATED	article identifier	Its attribute: code list reference Property: Aggregation Note_English Old value: <i>this attribute should be ALTERNATIVE to the others</i> New value: <i>at least one out of this attribute and "numberingOrg" should be set</i>

Element()	attachment	NEW	attachment	
Child	attachment	NEW	attachment	Has NEW child of: file name
Child	attachment	NEW	attachment	Has NEW child of: external reference
Child	attachment	NEW	attachment	Has NEW child of: binary object
Attribute	binary Object	NEW	binary object	Has NEW attribute: encoding
Attribute	binary Object	NEW	binary object	Has NEW attribute: mime
Attribute	binary Object	NEW	binary object	Has NEW attribute: format
Attribute	binary Object	NEW	binary object	Has NEW attribute: character set
Element()	binary Object	NEW	binary object	
Child	buyer	NEW	Buyer (*)	Has NEW child of: Party identifier
Child	buyer	NEW	Buyer (*)	Has NEW child of: Additional Party Identifier
Attribute	buyer	NEW	Buyer (*)	Has NEW attribute: sender Party qualifier
Child	pieceCut	UPDATE	Chained piece data	relationship with child: serial number Property: Cardmax Old value: 1 New value: 9
Child	pieceCut	UPDATE	Chained piece data	relationship with child: serial number Property: Aggregation Note_English Old value: New value: <i>multiple values of serialN are allowed in order to provide different representations of the serial identifier of the same piece. Different instances of serialN must differ at least for one value of idQualifier or numberingOrg</i>
Element()	characterSetCode	NEW	character set code	
Element()	characterSet	NEW	character set	
Element(E)	packageContainerN	UPDATE	container reference	Property: Length_Max Old value: 25 New value: 40

Element(E)	deliveryPlace	UPDATED	delivery place	Property: Length_Max Old value: 40 New value: 250
Attribute	description	NEW	description	Has NEW attribute: In
Element(E)	description	UPDATED	description	Property: Length_Max Old value: 70 New value: 250
Attribute	despatchDate	NEW	despatch date	Has NEW attribute: date format
Element(I)	despatchDate	NEW	despatch date	
Element(I)	despatchPlace	NEW	despatch place	
Element(E)	email	UPDATED	e-mail	Property: Length_Max Old value: 80 New value: 250
Element(I)	encodingCode	NEW	encoding code	
Element(I)	encoding	NEW	encoding	
Child	externalReference	NEW	external reference	Has NEW child of: uri
Child	externalReference	NEW	external reference	Has NEW child of: format code
Child	externalReference	NEW	external reference	Has NEW child of: character set code
Child	externalReference	NEW	external reference	Has NEW child of: mime code
Child	externalReference	NEW	external reference	Has NEW child of: encoding code
Element(I)	externalReference	NEW	external reference	
Element(E)	fabricCharacterText	UPDATED	fabric characteristic text	Property: Length_Max Old value: 40 New value: 80
Child	fabricComponent	NEW	fabric component	Has NEW child of: items list

Child	fabricComponent	UPDATED	fabric component	relationship with child: general note Property: Cardmax Old value: 19 New value: 99
Child	fabricComponent	UPDATED	fabric component	relationship with child: location identifier Property: Aggregation Note_English Old value: <i>it may be used to specify the location where lie the pieces that the Subcontractor must use for the commissioned work operation</i> New value: <i>it may be used to specify the location where lie the pieces that the Subcontractor must use for the commissioned work operation</i>
Child	fabricComponent	UPDATED	fabric component	relationship with child: serial number Property: Grp_pos Old value: 0 New value: 1
Child	fabricComponent	UPDATED	fabric component	relationship with child: serial number Property: Gruppo Old value: 0 New value: -1
Child	fabricComponent	UPDATED	fabric component	relationship with child: serial number Property: Cardmax Old value: 99 New value: 999
Child	fabricComponent	UPDATED	fabric component	relationship with child: product quantity Property: Aggregation Note_English Old value: <i>here is the code of the component used in the yarn manufacturing operation</i> New value: <i>quantity to be consumed in the transformation. This element can have more instances only if the units of measure are different</i>
Child	fabricComponent	UPDATED	fabric component	relationship with child: reference document details Property: Cardmax Old value: 1 New value: 9
Child	piece	NEW	Fabric piece data	Has NEW child of: gross weight measure
Child	piece	UPDATED	Fabric piece data	relationship with child: serial number Property: Cardmax Old value: 3 New value: 9

Child	piece	UPDATED	Fabric piece data	relationship with child: serial number Property: Cardmin Old value: 1 New value: 0
Child	piece	UPDATED	Fabric piece data	relationship with child: serial number Property: BestPractice_English Old value: New value: <i>This element might contain also codes for RFID devices.</i>
Child	piece	UPDATED	Fabric piece data	relationship with child: manufacture lot identifier Property: Cardmax Old value: 1 New value: 2
Child	piece	UPDATED	Fabric piece data	relationship with child: manufacture lot identifier Property: Aggregation Note_English Old value: New value: <i>The lotN instances must differ by value of the numberingOrg attribute</i>
Child	piece	UPDATED	Fabric piece data	relationship with child: piece weight measure Property: Aggregation Note_English Old value: New value: <i>It is the net weight of the piece.</i>
Child	piece	UPDATED	Fabric piece data	relationship with child: electronic product code Property: Aggregation Note_English Old value: New value: <i>the use of this element is DEPRECATED, use the appropriate elements (serialN)</i>
Child	piece	UPDATED	Fabric piece data	relationship with child: serial number Property: Aggregation Note_English Old value: <i>More than one serialN is accepted only if the numbering organizations are different (and the piece is the same)</i> New value: <i>multiple values of serialN are allowed for different representations of the serial identifier of the same piece. Instances of serialN must differ at least for one value of numberingOrg and idQualifier.</i>
Element(E)	piecePackText	UPDATED	fabric piece packing text	Property: Length_Max Old value: 40 New value: 250
Child	fabPrintOperation	UPDATED	fabric printing operation	relationship with child: general note Property: Cardmax

				Old value: 19 New value: 99
Child	fabPrintOperation	UPDATED	fabric printing operation	relationship with child: reference document details Property: Cardmax Old value: 1 New value: 9
Element(E)	fabPrintCharText	UPDATED	fabric printing parameter text	Property: Length_Max Old value: 70 New value: 250
Child	fabricProduct	UPDATED	fabric product	relationship with child: general note Property: Cardmax Old value: 19 New value: 99
Attribute	fileName	NEW	file name	Has NEW attribute: numbering organisation code
Element(l)	fileName	NEW	file name	
Element(l)	formatCode	NEW	format code	
Element(l)	format	NEW	format	
Attribute	note	UPDATED	general note	Its attribute: numbering organisation code Property: Aggregation Note_English Old value: New value: <i>must be used to specify the organization that created the list of codes used in "noteLabel"</i>
Element(l)	idQualifier	NEW	id Qualifier	
Element(l)	isCharge	NEW	is Charge	
Element(l)	isURL	NEW	is URL	
Child	itemIdentification	NEW	item identification	Has NEW child of: serial number
Element(l)	itemIdentification	NEW	item identification	

Child	itemsList	NEW	items list	Has NEW child of: quality level
Child	itemsList	NEW	items list	Has NEW child of: item identification
Element()	itemsList	NEW	items list	
Element(E)	legalName	UPD ATED	Legal name	Property: Length_Max Old value: 80 New value: 250
Element(E)	itemID	UPD ATED	line item number	Property: Length_Max Old value: 6 New value: 40
Attribute	lineN	UPD ATED	line number	Its attribute: VAT rate Property: Aggregation Note_English Old value: New value: <i>Deprecated, prefer dtScheme when available.</i>
Element()	ln	NEW	ln	
Element()	maxQty	NEW	maximum quantity	
Element()	mimeCode	NEW	mime code	
Element()	mime	NEW	mime	
Element(E)	packageName	UPD ATED	package number	Property: Length_Max Old value: 25 New value: 40
Child	pieceChain	UPD ATED	piece chain	relationship with child: serial number Property: Aggregation Note_English Old value: New value: <i>multiple values of serialN are allowed in order to provide different representations of the serial identifier of the same piece chain. Different instances of serialN must differ at least for one value of idQualifier or numberingOrg</i>
Child	pieceChain	UPD ATED	piece chain	relationship with child: serial number Property: Cardmax Old value: 1 New value: 9
Element()	progr	NEW	progressive number	

Attr ib	quality Level	NE W	quality lev el	Has NEW attribute: numbering organisation code
Attr ib	quality Level	NE W	quality lev el	Has NEW attribute: code list reference
Attr ib	quality Level	NE W	quality lev el	Has NEW attribute: code list version
Attr ib	quality Level	NE W	quality lev el	Has NEW attribute: code list name
Ele m(I)	quality Level	NE W	quality lev el	
Chi ld	refDoc	NE W	reference document details	Has NEW child of: attachment
Chi ld	refDoc	UPD ATE D	reference document details	relationship with child: document identifier Property: BestPractice_English Old value: New value: <i>numberingOrg</i> indicates the role that produced the document i dentifier (it is allowed to declare two different ones -e.g. customer and sup plier - with two docID with different numberingOrg
Attr ib	season	NE W	season id entifier	Has NEW attribute: code list reference
Attr ib	season	NE W	season id entifier	Has NEW attribute: numbering organisation code
Attr ib	season	NE W	season id entifier	Has NEW attribute: code list name
Attr ib	season	NE W	season id entifier	Has NEW attribute: code list version
Attr ib	serialN	NE W	serial nu mber	Has NEW attribute: id Qualifier
Ele m(E)	serialN	UPD ATE D	serial nu mber	Property: Length_Max Old value: 15 New value: 250
Chi ld	subCo ntracto r	NE W	Sub-contr actor (*)	Has NEW child of: Party identifier
Attr ib	subCo ntracto r	NE W	Sub-contr actor (*)	Has NEW attribute: sender Party qualifier
Ele m(I)	subDe pt	NE W	departme nt identifi er	
Attr ib	legalR ef	NE W	tax legal r eference	Has NEW attribute: code list name
Attr ib	legalR ef	NE W	tax legal r eference	Has NEW attribute: numbering organisation code

Attr ib	legalR ef	NE W	tax legal r eference	Has NEW attribute: code list version
Attr ib	legalR ef	UPD ATE D	tax legal r eference	Its attribute: code list reference Property: Use Old value: <i>Required</i> New value: <i>Optional</i>
Chi ld	dtSche me	UPD ATE D	tax sche me	relationship with child: general note Property: Cardmax Old value: 19 New value: 99
Ele m(E)	payTer mText	UPD ATE D	terms of p ayment te xt	Property: Length_Max Old value: 40 New value: 250
Ele m(E)	incoTe rmText	UPD ATE D	terms of tr ade text	Property: Length_Max Old value: 70 New value: 250
Ele m(E)	metho d	UPD ATE D	test meth od identifi er	Property: Length_Max Old value: 25 New value: 80
Chi ld	texCod e	UPD ATE D	Textiles p roduct co de	relationship with child: description Property: Aggregation Note_English Old value: New value: <i>Product description</i>
Chi ld	texCod e	UPD ATE D	Textiles p roduct co de	relationship with child: description Property: Cardmax Old value: 1 New value: 999
Chi ld	thirdPa rty	NE W	Third Part y (*)	Has NEW child of: Party identifier
Attr ib	thirdPa rty	NE W	Third Part y (*)	Has NEW attribute: sender Party qualifier
Chi ld	TPCXh eader	UPD ATE D	TPCX he ader	relationship with child: reference document details Property: Aggregation Note_English Old value: New value: <i>At least one occurrence should contain a reference to the order it responds to (for example docType=ORD or OCH or BOR)</i>
Chi ld	TPCXh eader	UPD ATE D	TPCX he ader	relationship with child: general note Property: Cardmax Old value: 19 New value: 99

Child	TPCXheader	UPDATE	TPCX header	relationship with child: Third Party Property: Cardmax Old value: 1 New value: 5
Child	TPCXitem	UPDATE	TPCX item	relationship with child: reference document details Property: Aggregation Note_English Old value: New value: <i>At least one occurrence should contain a reference to the line of the order it responds to (for example docType=ORD or OCH or BOR)</i>
Child	TPCXitem	UPDATE	TPCX item	relationship with child: Third Party Property: Cardmax Old value: 1 New value: 3
Child	terms	UPDATE	Trade conditions	relationship with child: Transport information Property: Cardmax Old value: 1 New value: 5
Element(E)	transConditionText	UPDATE	transport condition - text	Property: Length_Max Old value: 100 New value: 250
Child	transInfo	NEW	Transport information	Has NEW child of: despatch place
Child	transInfo	NEW	Transport information	Has NEW child of: despatch date
Child	transInfo	NEW	Transport information	Has NEW child of: effective delivery date
Attribute	transInfo	NEW	Transport information	Has NEW attribute: progressive number
Attribute	price	NEW	unit price amount	Has NEW attribute: data currency
Element(E)	price	UPDATE	unit price amount	Property: Digits_Dec Old value: 2 New value: 4
Attribute	uri	NEW	uri	Has NEW attribute: is URL
Element(I)	uri	NEW	uri	

Annex D

New or changed tables and codes towards previous version

Changes or added items (changes in CodeListAgencyName excluded; changes in adoption notes and code description included): 157

Test Type	Status	Table code	Table description	Code	Change description
Table	UPDATED	NT100	eBIZ TCFUpstream version		Description_English Old value: <i>eBIZ Moda-ML version</i> New value: <i>eBIZ TCFUpstream version</i>
Code	NEW	NT100		2018-1 (v2018-1)	
Code	NEW	NT100		draft (draft)	
Table	UPDATED	NT16	VAT rate or code		Generalities Old value: <i>VAT rate or code (deprecated, use dtScheme element)</i> New value: <i>VAT rate or code (DEPRECATED, use dtScheme element)</i>
Code	NEW	NT2		AU (Auditor)	
Code	NEW	NT2		CE (Certification authority)	
Code	NEW	NT2		SC (Sub contractor)	
Code	NEW	NT2		SM (Service/ePlatform manager)	
Code	NEW	NT4		SA (Sample)	
Table	UPDATED	NT4	end use		Generalities Old value: <i>specifies the final use of the fabric</i> New value: <i>specifies the final use of the product</i>
Code	NEW	NT6		EB (eBIZ)	
Code	UPDATED	NT6		ML (DEPRECATED)	adoption_note Old value: New value: <i>DEPRECATED</i>
Table	NEW	NT60	language, codes from ISO 639-1 (subset)		

Co de	NEW	NT 60		<i>F</i> (Female)	
Co de	NEW	NT 60		<i>af</i> (Afrikaans)	
Co de	NEW	NT 60		<i>ar</i> (Arabic)	
Co de	NEW	NT 60		<i>be</i> (Belarusian)	
Co de	NEW	NT 60		<i>bg</i> (Bulgarian)	
Co de	NEW	NT 60		<i>bn</i> (Bengali)	
Co de	NEW	NT 60		<i>bo</i> (Tibetan)	
Co de	NEW	NT 60		<i>bs</i> (Bosnian)	
Co de	NEW	NT 60		<i>ca</i> (Catalan, Valencian)	
Co de	NEW	NT 60		<i>cs</i> (Czech)	
Co de	NEW	NT 60		<i>da</i> (Danish)	
Co de	NEW	NT 60		<i>de</i> (German)	
Co de	NEW	NT 60		<i>el</i> (Greek, Modern (1453-))	
Co de	NEW	NT 60		<i>en</i> (English)	
Co de	NEW	NT 60		<i>eo</i> (Esperanto)	
Co de	NEW	NT 60		<i>es</i> (Spanish, Castilian)	
Co de	NEW	NT 60		<i>et</i> (Estonian)	
Co de	NEW	NT 60		<i>eu</i> (Basque)	
Co de	NEW	NT 60		<i>fa</i> (Persian)	
Co de	NEW	NT 60		<i>fi</i> (Finnish)	
Co de	NEW	NT 60		<i>fr</i> (French)	
Co de	NEW	NT 60		<i>ga</i> (Irish)	

Co de	NEW	NT 60		<i>gd</i> (Gaelic, Scottish Gaelic)	
Co de	NEW	NT 60		<i>gn</i> (Guarani)	
Co de	NEW	NT 60		<i>he</i> (Hebrew)	
Co de	NEW	NT 60		<i>hr</i> (Croatian)	
Co de	NEW	NT 60		<i>ht</i> (Haitian, Haitian Creole)	
Co de	NEW	NT 60		<i>hu</i> (Hungarian)	
Co de	NEW	NT 60		<i>hy</i> (Armenian)	
Co de	NEW	NT 60		<i>ia</i> (Interlingua (International Au xiliary Language Association))	
Co de	NEW	NT 60		<i>id</i> (Indonesian)	
Co de	NEW	NT 60		<i>is</i> (Icelandic)	
Co de	NEW	NT 60		<i>it</i> (Italian)	
Co de	NEW	NT 60		<i>ja</i> (Japanese)	
Co de	NEW	NT 60		<i>ju</i> (Javanese)	
Co de	NEW	NT 60		<i>ka</i> (Georgian)	
Co de	NEW	NT 60		<i>km</i> (Central Khmer)	
Co de	NEW	NT 60		<i>ko</i> (Korean)	
Co de	NEW	NT 60		<i>ku</i> (Kurdish)	
Co de	NEW	NT 60		<i>lb</i> (Luxembourgish, Letzeburge sch)	
Co de	NEW	NT 60		<i>lo</i> (Lao)	
Co de	NEW	NT 60		<i>lt</i> (Lithuanian)	
Co de	NEW	NT 60		<i>lv</i> (Latvian)	

Co de	NEW	NT 60		<i>mg</i> (Malagasy)	
Co de	NEW	NT 60		<i>mk</i> (Macedonian)	
Co de	NEW	NT 60		<i>mn</i> (Mongolian)	
Co de	NEW	NT 60		<i>mt</i> (Maltese)	
Co de	NEW	NT 60		<i>nl</i> (Dutch, Flemish)	
Co de	NEW	NT 60		<i>no</i> (Norwegian)	
Co de	NEW	NT 60		<i>pl</i> (Polish)	
Co de	NEW	NT 60		<i>pt</i> (Portuguese)	
Co de	NEW	NT 60		<i>ro</i> (Romanian, Moldavian, Mold ovan)	
Co de	NEW	NT 60		<i>ru</i> (Russian)	
Co de	NEW	NT 60		<i>se</i> (Northern Sami)	
Co de	NEW	NT 60		<i>sk</i> (Slovak)	
Co de	NEW	NT 60		<i>sl</i> (Slovenian)	
Co de	NEW	NT 60		<i>sm</i> (Samoan)	
Co de	NEW	NT 60		<i>so</i> (Somali)	
Co de	NEW	NT 60		<i>sq</i> (Albanian)	
Co de	NEW	NT 60		<i>sr</i> (Serbian)	
Co de	NEW	NT 60		<i>sv</i> (Swedish)	
Co de	NEW	NT 60		<i>sw</i> (Swahili)	
Co de	NEW	NT 60		<i>ta</i> (Tamil)	
Co de	NEW	NT 60		<i>th</i> (Thai)	
Co de	NEW	NT 60		<i>tr</i> (Turkish)	

Co de	NEW	NT 60		<i>uk</i> (Ukrainian)	
Co de	NEW	NT 60		<i>ur</i> (Urdu)	
Co de	NEW	NT 60		<i>uz</i> (Uzbek)	
Co de	NEW	NT 60		<i>vi</i> (Vietnamese)	
Co de	NEW	NT 60		<i>zh</i> (Chinese)	
Co de	NEW	NT 7		<i>CMK</i> (square centimetre)	
Co de	NEW	NT 7		<i>CMQ</i> (cubic centimetre)	
Co de	NEW	NT 7		<i>E37</i> (pixel)	
Co de	NEW	NT 7		<i>KWH</i> (kilowatthours)	
Co de	NEW	NT 7		<i>MMK</i> (square millimetre)	
Co de	NEW	NT 7		<i>MTK</i> (square metre)	
Co de	NEW	NT 7		<i>CO2TON</i> (ton of CO2)	
Table	UPD ATED	NT 7	unit of measure		OtherExternalReferenceURL Old value: New value: #http://docs.oasis-open.org/ubl/os-UBL-2.1/cl/gc/default/UnitOfMeasureCode-2.1.gc#
Table	UPD ATED	NT 7	unit of measure		Description_English Old value: <i>unity of measure</i> New value: <i>unit of measure</i>
Co de	NEW	T2 1		<i>BOR</i> (blanket order)	
Co de	NEW	T2 1		<i>CEO</i> (Certificate of origin)	
Co de	NEW	T2 1		<i>CER</i> (Certificate)	
Co de	UPD ATED	T2 1		<i>CTR</i> (Contract)	Text_English Old value: <i>contract</i> New value: <i>Contract</i>
Co de	NEW	T2 1		<i>MCI</i> (Visual merchandising instruction)	
Co de	NEW	T2 1		<i>VMI</i> (visual merchandising instructions)	

Co de	NEW	T4 1		1 (Agreed settlement)	
Co de	NEW	T4 1		2 (Below specification goods)	
Co de	NEW	T4 1		3 (Damaged goods)	
Co de	NEW	T4 1		4 (Short delivery)	
Co de	NEW	T4 1		7 (Payment on account)	
Co de	NEW	T4 1		8 (Returnable container charge included)	
Co de	NEW	T4 1		9 (Invoice error)	
Co de	NEW	T4 1		10 (Costs for draft)	
Co de	NEW	T4 1		11 (Bank charges)	
Co de	NEW	T4 1		12 (Agent commission)	
Co de	NEW	T4 1		14 (Wrong delivery)	
Co de	NEW	T4 1		15 (Goods returned to agent)	
Co de	NEW	T4 1		16 (Goods partly returned)	
Co de	NEW	T4 1		17 (Transport damage)	
Co de	NEW	T4 1		19 (Trade discount)	
Co de	NEW	T4 1		20 (Deduction for late delivery)	
Co de	NEW	T4 1		21 (Advertising costs)	
Co de	NEW	T4 1		22 (Customs duties)	
Co de	NEW	T4 1		23 (Telephone and postal costs)	
Co de	NEW	T4 1		24 (Repair costs)	
Co de	NEW	T4 1		25 (Attorney fees)	
Co de	NEW	T4 1		26 (Taxes)	

Co de	NEW	T4 1		30 (Direct payment to seller)	
Co de	NEW	T4 1		32 (Goods not delivered)	
Co de	NEW	T4 1		33 (Late delivery)	
Co de	NEW	T4 1		35 (Goods returned)	
Co de	NEW	T4 1		36 (Invoice not received)	
Co de	NEW	T4 1		37 (Credit note to debtor/not to us)	
Co de	NEW	T4 1		38 (Deducted bonus)	
Co de	NEW	T4 1		39 (Deducted discount)	
Co de	NEW	T4 1		40 (Deducted freight costs)	
Co de	NEW	T4 1		41 (Deduction against other invoices)	
Co de	NEW	T4 1		42 (Credit balance(s))	
Co de	NEW	T4 1		45 (Debit note to seller)	
Co de	NEW	T4 1		46 (Discount beyond terms)	
Co de	NEW	T4 1		48 (Allowance/charge error)	
Co de	NEW	T4 1		49 (Substitute product)	
Co de	NEW	T4 1		50 (Terms of sale error)	
Co de	NEW	T4 1		52 (Wrong invoice)	
Co de	NEW	T4 1		53 (Duplicate invoice)	
Co de	NEW	T4 1		54 (Weight error)	
Co de	NEW	T4 1		55 (Additional charge not authorized)	
Co de	NEW	T4 1		56 (Incorrect discount)	

Code	NEW	T4 1		57 (Price change)	
Code	NEW	T4 1		58 (Variation)	
Code	NEW	T4 1		59 (Chargeback)	
Code	NEW	T4 1		65 (Settlement to agent)	
Code	NEW	T4 1		66 (Cash discount)	
Code	NEW	T4 1		70 (Wrong monetary amount resulting from incorrect free goods quantity)	
Code	NEW	T4 1		72 (Temporary special promotion)	
Code	NEW	T4 1		73 (Difference in tax rate)	
Code	NEW	T4 1		74 (Quantity discount)	
Code	NEW	T4 1		75 (Promotion discount)	
Code	NEW	T4 1		76 (Cancellation deadline passed)	
Code	NEW	T4 1		77 (Pricing discount)	
Code	NEW	T4 1		78 (Volume discount)	
Code	NEW	T4 1		79 (Sundry discount)	
Table	UPDATE	T4 1	type of Allowance or Charge		Generalities Old value: <i>coded specification of an Allowance or Charge</i> New value: <i>coded specification of an Allowance or Charge (elaborated from UNECE 4465)</i>
Code	NEW	T4 4		CO (company identification code)	